

The Callen Chronicles



T H E C A L L E N C H R O N I C L E S

**AKA
(CALLAN CALLIN CALLON)
(CALLENS CALLONS)**

Biographical - with Photographs

1990

**Researched and compiled by Callen family researchers & descendants
Coordinated and typed by Edna M Callen McNellis**

THE CALLEN COAT OF ARMS

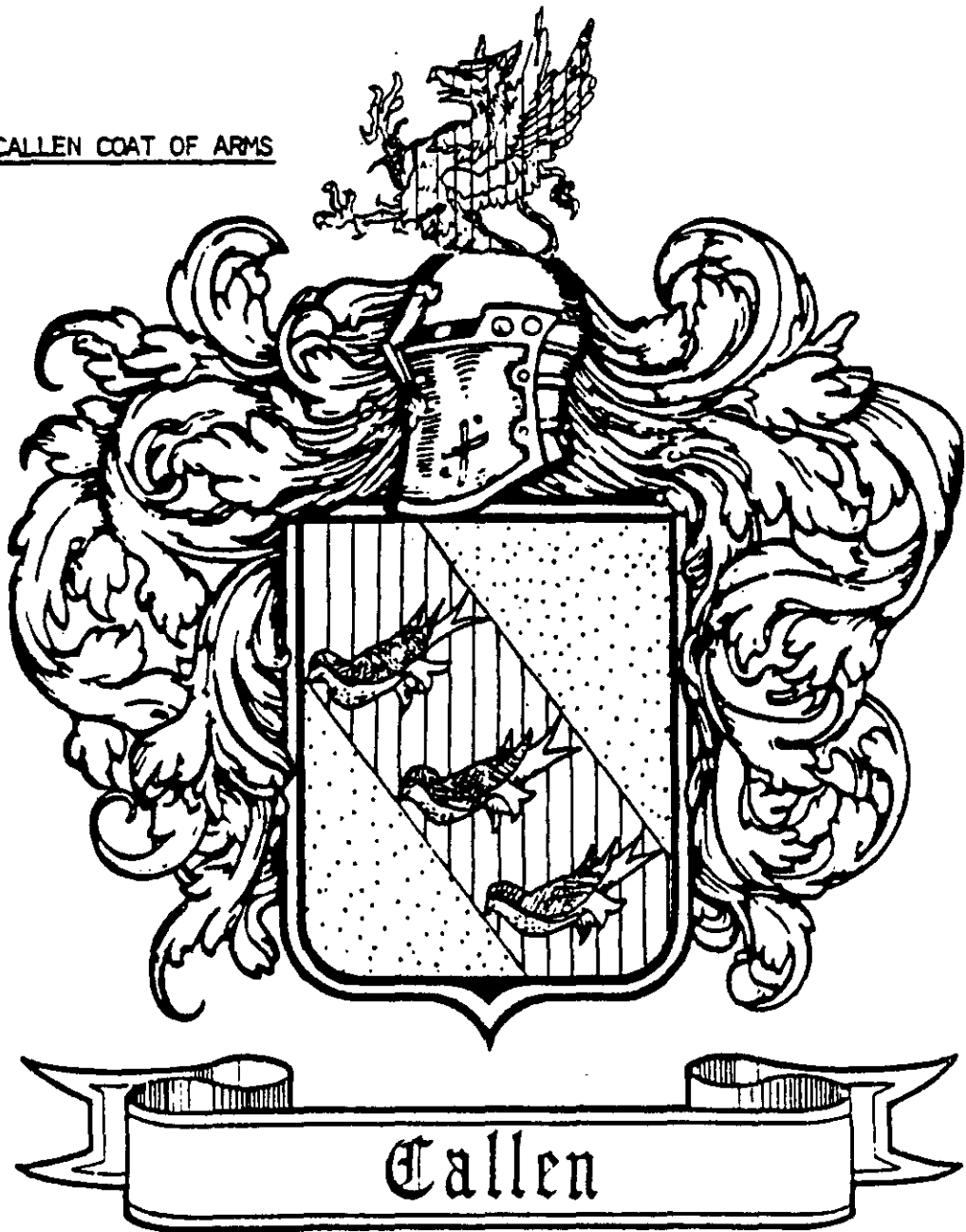

THE CALLEN COAT OF ARMS HEREBY ILLUSTRATED IS OFFICIALLY DOCUMENTED IN BURKE'S GENERAL ARMORY, THE ORIGINAL DESCRIPTION OF THE ARMS (SHIELD) IS AS FOLLOWS:

"OR, ON A BEND GU, THREE MARTLETS AR."

WHEN TRANSLATED THE BLAZON ALSO DESCRIBES THE ORIGINAL COLORS OF THE CALLEN ARMS AS:

"GOLD, A RED DIAGONAL BAND, THREE SILVER BIRDS WITHOUT FEET."

ABOVE THE SHIELD AND HELMET IS THE CREST WHICH IS DESCRIBED AS:

"HALF A RED GRIFFIN ATTACKING."

FORWARD

THE CALLEN CHRONICLES has been written with the purpose of recording the descendants of the Callen family who first appeared in Pennsylvania in the early 1700's.

Research indicates that two Scotch-Irish men named John and Edward Callen came to the English Colonies around 1733-1737 and settled in Lancaster County, Pennsylvania. We believe that the families featured in this book are direct descendants of, or at least related to, these two men.

This family history has been researched for many years, by many descendants. We've tried to make this history as accurate, complete and interesting as possible. However we, the compilers, disclaim all responsibility for possible mis-information or inaccuracies contained in this book.

Each descendant is listed showing their direct line of descent following their name. Each descendant has been given a Roman Numeral in order of birth. Those descendants that have additional information are also given an Arabic Numeral. This enables the reader to find any given name by consulting the Index and referring to the Arabic Number for that name.

The following abbreviations are used:

b.	born	m.	married
ca.	about	s/d	step daughter
Co.	county	s/s	Step son
d.	died	Twp	township

We are deeply grateful, and extend our thanks to all family members who have supplied us with information. (See bibliography for listings.)

Additional information, inquiries and corrections welcome. Please write to members of the Callen family-research network, names listed on page 5.

TABLE OF CONTENTS

Forward-----	1	3-William Callen Sr Families	191
Callen family-researchers---	5	2nd Generation-----	195
Callen Family in America----	7	Callen, John, will-----	195
		Callen, James, will-----	197
1-Patrick Callen Families---	17	3rd Generation-----	201
Callen, Patrick, will---	20	letter 1948-----	203
2nd Generation-----	25	Callen, John Kerr, will-	206
Callen, Hugh, will-----	30	Callen, William III will	209
3rd Generation-----	35	4th Generation-----	215
Callen, David, will-----	38	A marriage proposal-----	217
Callen, Eliza, obituary-	40	Callen, James Cicero, will	222
Callen, Jane E, obituary	41	5th Generation-----	229
Callen, Hugh Jr, will---	41	6th Generation-----	249
Callen, Jane(Shadle)obit	43	7th Generation-----	275
Callen, Arther F, obit--	47	Purcell, Col Wm Wood obit	290
4th Generation-----	49	8th Generation-----	301
Callen, Mary A obituary-	49	9th Generation-----	321
Callen, Josiah J will---	51		
Callen, David D, obit---	64	4-Charles Callen Sr Families	325
5th Generation-----	65	Callen, Charles deed----	326
Callen, James A, obit---	68	2nd Generation-----	327
Callen, Josiah P, obit--	69	3rd Generation-----	329
Callen, John H, will---	70	4th Generation-----	333
Callen, James E, will---	71	5th Generation-----	337
Callen, Arthur obituary-	77	6th Generation-----	343
Callen, Samuel W, obit--	79	7th Generation-----	347
letter 1947-----	85	8th Generation-----	351
6th Generation-----	91		
Callen, Vernon I, obit--	107	Appendix A-land deed, Pa----	353
7th Generation-----	111	Appendix B-land deed, NC----	359
8th Generation-----	125	Appendix C-land deed, NC----	370
9th Generation-----	137	Appendix D-land deed, NC----	375
		Bibliography-----	381
2-Samuel Callen Sr Families-	141	Index-----	387
Callen, Samuel Sr, will---	142		
2nd Generation-----	143	MAPS	
Callen, Jane H, obituary	143	Cumberland Co.-----	6
Callen, Robert M, will--	145	Pennsylvania, Co formations-	14
Callen, Mary C, will---	147	Pa, Counties & rivers-----	15
Callen, Rachel T, will--	152	U.S. - State formations-----	16
3rd Generation-----	153	Kittanning, Pa areas-----	18
The Kiskiminetas Squad--	154	Callensburg, Pa-----	27,28
Callen, H,A,& E, will---	157	North Carolina-----	193
4th Generation-----	165		
5th Generation-----	173		
6th Generation-----	183		
7th Generation-----	189		

CALLEN family researchers
(listed in alphabetical order - by family line)

1 - LINE OF PATRICK CALLEN

Peggy Allen
2000 W 2nd Ave #634
Denver, CO 80221

Win Ballenger (deceased)
Auburn, CA

Bessie Callen Leal
P.O. Box #46
Wheatland, CA 95692

Edna Callen McNellis
3654 Dean Drive
Barberton, OH 44203

2 - LINE OF SAMUEL CALLEN, SR

Georgia R Callen
P.O. Box #13
Amazonia, MO 64421

Gladys (V Kenneth) Callen
329 E 8th Ave
Ft Morgan, CO 80701

Dorothy Callen Laird
25 Betsy Ross Ct
Liberty, MO 64068

3 - LINE OF WILLIAM CALLEN SR

Linda Barnes
1229 Tanager
Garland, TX 75041

James Gilmer, Jr (deceased)
Knoxville, TN

Doris W Nelson
5331 Dumfries
Houston, TX 77096

Douglas Clare Purcell
633 N Randolph Ave.
Eufaula, AL 36027

Carolyn Glass Warren
1008 Oakhaven Circle
College Station, TX 77840

4 - LINE OF CHARLES CALLEN

Opal Callen
807 Lake
Trenton, MO 64683

Dorothy F McConahay
404 - 2nd St
Columbus Jct, IA 52738

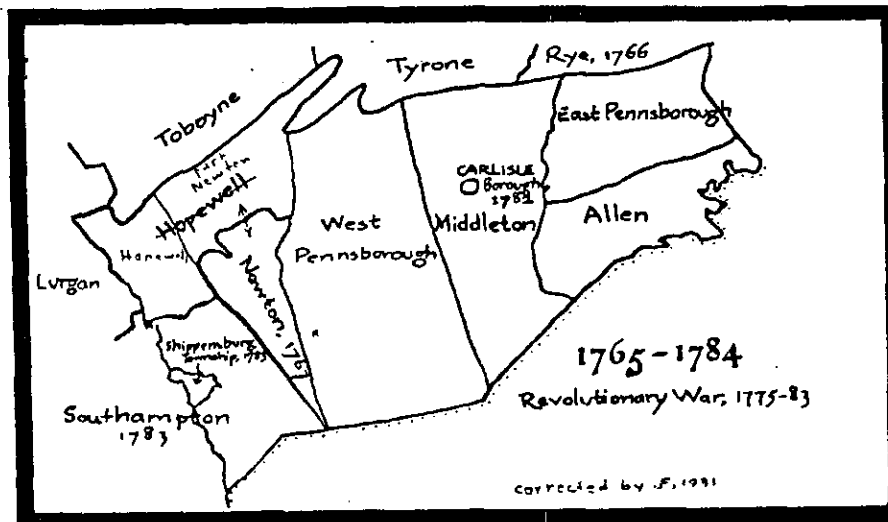
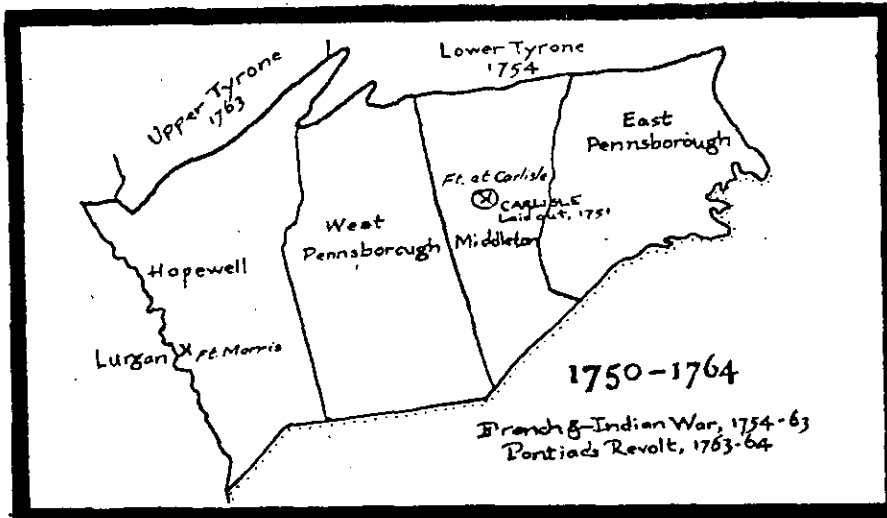
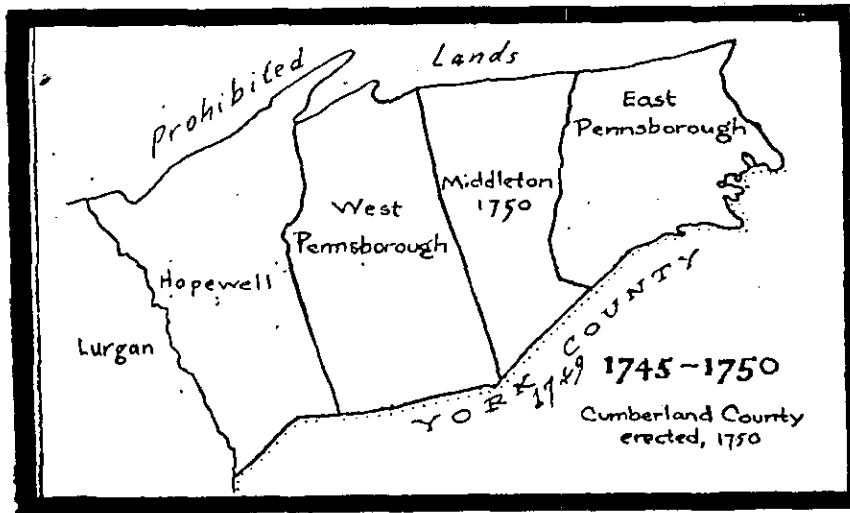

**TOWNSHIP FORMATIONS
CUMBERLAND CO., PA**

THE CALLEN FAMILIES IN COLONIAL AMERICA

The CALLEN family name first appears in America around 1733 in eastern Pennsylvania. It appears evident that these early pioneers were of Scotch-Irish heritage, and immigrated to the Colonies in order to gain greater religious and economic freedom. There were many CALLEN men in Pennsylvania and the Colonies through the 1700's, and although there is agreement that several were probably brothers, we have no proof as to their exact relationships.

"The Scotch-Irish who settled in America came from Ireland, but they were chiefly of Scottish descent. In 1611 King James I of England, ...began to colonize Ulster in northern Ireland with Protestant people from Scotland and northern England. Most of these colonist sent to Ulster were Lowland Scotch Presbyterians, adherents of the teachings of John Knox. After a considerable part of the Catholic Irish inhabitants of that fertile part of Ireland had been expelled by Oliver Cromwell, many other Scotch Presbyterians settled there. The so-called Scotch-Irish were neither true Scots nor true Irish in the ethnological sense. They had in their veins the blood of the earliest Britons and later Scandinavian invaders. But they were called Scotch-Irish (S-I) because they had lived in Scotland and moved to Ireland.

"The Scotch Presbyterians -- afterward known as Orangemen -- prospered and multiplied rapidly in Northern Ireland...Naturally, there was some intermixture between the Scotch and English on the one hand and the native Irish on the other. Their chief industry was the manufacture of woolen and linen cloth. In process of time, however, the Scotch Presbyterians of Ireland clashed with the economic and religious policies of the British Government. Parliament undertook to make them conform to the Anglican worship and in 1698 and later passed laws that greatly injured the woolen and linen industry of Ulster. Desirous of the greater religious liberty and economic opportunity, large numbers of people from Ulster began to migrate to America. Between 1730 and 1770 several hundred thousand Scotch-Irish came to the English Colonies...

"They were staunch Calvinists, and everywhere they went they took their Presbyterian faith with them...Many of them went to Pennsylvania...Some of the settlers of other nationalities regarded the Scotch-Irish as zealots in religion, in the exercise of personal independence and in the acquisition of land. It was said of them that they kept the Sabbath and everything else they could lay their hands on...It is estimated that one-third of the population of Pennsylvania was Scotch-Irish in 1770..." (A Book About American History by George Stimpson)

(35A)The Port of Entry used by the Scotch-Irish ca 1730 was Newcastle, Delaware. We are told that records were not always kept of the Scotch-Irish immigrants because they were merely moving from one English province to another, therefore we have not found any record of the original Callen migration.

The S-I then went by a new road constructed in 1733 through "The Gap" near Octorara Creek into Lancaster Co., Pa. The heaviest settlement in the Cumberland Valley in Pennsylvania was by the Scotch-Irish from 1731 to 1735.

1731 -- The first thing the S-I did upon arrival in an area was to establish a Presbytery, and accordingly the Mercersburg Presbyterian Church was established in 1731 in the Cumberland Valley then part of Lancaster Co, Pa.

1733 -- On April 9, 1733 - According to "History of Cumberland Valley" by Geo D Blunston (magistrate named by the Penns as responsible for issuing the land patents for that area), JOHN CALLEN was issued a patent for 200 acres in Lancaster Co. This land was located west of the Susquehanna River and south of the Conodoguinet Creek. The property is in the vicinity of Hogestown, Carlisle and Mercersburg, just West of Harris' Ferry (Harrisburg), which was then "the gateway to the West".

(35A)For many years, Carlisle was the terminus of the old wagon road along the "Raystown Path" or "National Highway". It was not extended until 1758 or so. Until that time, travel was by foot or horseback and all freight moved by pack horses. It is said that travel at that time was "little less than a continuance of miracles" and most preferred to cross the Alleghenies by foot, rather than to risk life and limb in a wagon." (Wayland Dunaway's "The S-I in Colonial Pennsylvania")

1734 -- About a thousand people settled in the Kittochtinny Valley, nine-tenths of whom were Scotch-Irish. These people rarely purchased land, preferring tenancy "at will" and fully believing in "squatter's rights". Since they were always on the edge of civilization, they deemed it their right to take over the lands of the Indians, which were nominally controlled at the time by the Penns. A letter to the Provincial Government in 1734, by Logan, the secretary of the province, bemoans the fact that the Scotch-Irish and the Scotch had taken up western lands though they rarely approached him to purchase the land. Quoth he "I look upon them as bold and indigent strangers, giving as their excuse, when challenged for titles, that we had solicited for colonists, and they had come accordingly!" However, they were generally not molested, for they were exempted from the payment of rents in consequence of their being frontier-men, and forming a cordon of defence to the colony. ("History of Juniata Valley" by U.J. Jones)

1736 -- The Penn's proprietors purchased the Cumberland Valley from the Indians in order to avoid problems between the Indians and the settlers.

1737 -- According to the Pennsylvania Archives EDWARD and JOHN CALLEN each took up 200 acres of land in then Lancaster County. (43A)JOHN CALLEN appears in the Pa records in 1737, making application for a tract of land, about 350 acres, lying west of the Susquehanna River and south of the Conodoguinet Creek, in the vicinity of Hogestown. In this transaction John is referred to as

"yeoman", a term used to identify a man who farmed his own land. This would indicate that John already had settled and improved the land, possibly the same land to which he had applied for the title. The land was granted to him.

"John Hoge settled very early on the site of Hogestown...Two brothers, named Orr, coming from Ireland before 1738, settled near him...In the same neighborhood were...JOHN CALLEN, John Watts, Michael Kilpatrick... James Armstrong." (History of Cumberland and Adams Counties, Pennsylvania)

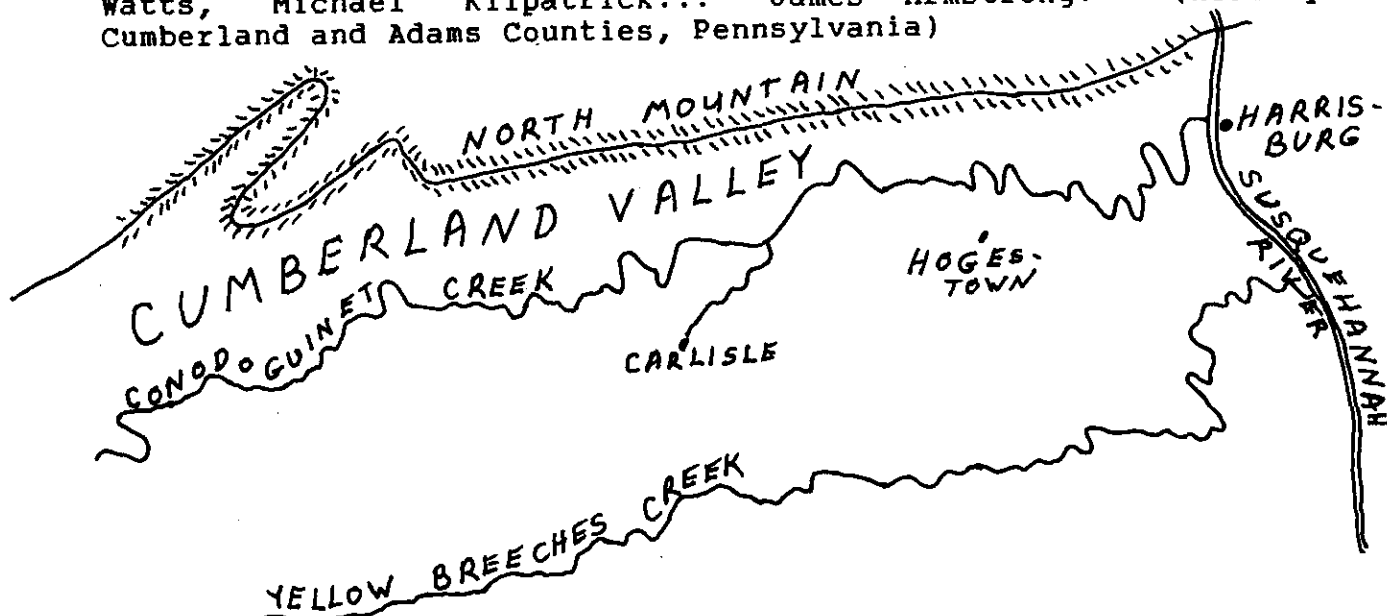

1742 -- On March 3, 1742, JOHN CALLEN received a patent for 362 acres of land in Pennsborough Township, Lancaster Co, Pa from the Penns. This is recorded in patent Book A, Vol 11, on page 166.

1742 -- On March 4, 1742 JOHN CALLEN mortgaged this land to Richard Peters (a representative of the Penn's) for 75 lbs to be paid back over five years as follows:

- 19 lbs, 10 shillings due on the 4th day of March 1743
- 18 lbs, ___ shillings due on the 4th day of March 1744
- 17 lbs, 14 shillings due on the 4th day of March 1745
- 15 lbs, 18 shillings due on the 4th day of March 1747

SEE APPENDIX A FOR TRANSCRIPT OF DEED

(43A)"The mortgage was marked as being satisfied on May 8, 1744; however on the same date JOHN CALLEN executed another mortgage covering the same property for the sum of Two hundred fifteen pounds which appears to be a one year lien. No notes found as to whether or when this lien was satisfied, but on Feb 28, 1754 Richard Peters sold the land, or a portion of it, to a John McClure."

SEE APPENDIX A FOR TRANSCRIPT OF DEED

1744-1764 --(43A)Between 1744, when JOHN CALLEN is last recorded and

heard of, to when the Callen name again appears, Western Pennsylvania was devastated by hostilities precipitated by the French and Indian Wars, the French having begun "as early as 1730 to alienate the Indians and the English."

The hostilities began around 1754 and the Indian Wars ravaged the frontier until 1764. With the defeat of General Braddock in 1755 the western Pennsylvania frontier was left exposed. Most of the settlers fled, either to the protection of the forts or out of the area entirely. All chronicles of that period refer to the widespread devastation of homesteads and heavy loss of life among the settlers. There was a brief respite between 1760 and 1763, until the beginning of Pontiac's War which lasted into 1764.

From the diary of a member of a military escort traveling from Ft. Pitt to Bedford, stopping in the vicinity of Fort Ligonier: "There were no settlers in the valley. They had all fled the Spring before or had given up and gone even farther eastward. If anything, the frontier was more dangerous now than it had been for some years. The valley...lay desolate and desolated."

During this period the Quaker government had ignored the "frantic" pleas of the Governor and military leaders for supplies. The militant Scotch-Irish had a "hatred and contempt" for the pacifist Quakers that was stirring into revolt. In a desperate move, "a wagon load of scalped and mangled corpses was drawn past the State House" and a group of "...Presbyterian Scotch Irish, fortified by whiskey and prayers and armed with long greased rifles, descended with blackened faces and Indian costumes upon Philadelphia," to impress upon the Friends that there were indeed people in the world who deserved the title "enemy." "The Quaker utopia by the Delaware (River) finally opened its eyes, a bit, to the terrible glow of burning cabins on the frontier." (From Bedford Village written by Harvey Allen, based on factual information.)

1750 - CUMBERLAND COUNTY was formed from parts of Lancaster County.

1762 -- WILLIAM CALLEN married ELIZABETH TAYLOR of Virginia (see chapter on William Callen Sr)

1762 -- SIMON CALLINS is listed as a resident of Carlisle, Pa (History of Cumberland and Adams Counties, Pennsylvania)

1766 -- There is a record of the marriage between EDWARD CALLEN to JANE MCILROY in the Province of Pennsylvania on December 18, 1766. It is not know if he is the Edward Callen who purchased land in 1737, or a son of Edward or John, or perhaps a new immigrant himself.

1768 -- April 4 JOSEPH CALLEN is a witness to a land transaction between Alexander Mathews, Sr and George Mathews - the land being situated in Hopewell Township, Cumberland Co, Pa (Cumberland Co Archives)

1768 -- WILLIAM CALLANS is shown on a tax list in East Pennsborough Twp, Cumberland County. He was taxed for 1 horse, 1 cow, and 100

acres of land, with 30 acres cleared. (Cumberland Co tax records - interesting note that Jonathan & David Hoges and John & William Orr are also on this tax list - see 1737 paragraph 2.)

1769-1770 -- (43A) Settlements were being renewed. In Bedford County (which became Westmoreland County in 1773) land could also be acquired from Virginia. "Tomahawk rights" were recognized, so that squatters were given title, defacto. Both colonies allowed a pre-emption right by improvement. A majority of settlers in the forks of the Yough River retained their lands under Virginia jurisdiction. After 1769, with the opening of the land office, rights were granted by the Penns.

1769 -- WILLIAM CAMELIN is shown on a tax list in West Pennsborough Twp, Cumberland Co. He was taxed for 1 horse, 1 cow, 100 acres of land, with 35 acres cleared. We feel that the name was misspelled and that this is the same William Callans as shown on the 1768 tax list in East Pennsborough Twp.

1769 -- On the same West Pennsborough tax list we find PATRICK CALLEN. He was taxed for 1 horse, 1 cow, 2 sheep, with 50 acres warrented having 10 acres cleared.

1769 -- WILLIAM CALIN was a witness to a land transaction on Christian's Creek in Augusta Co, Va. On Nov 8th WILLIAM CALLEN was surveyed 280 acres of land in Rockingham Co, Va.

1770 -- PATRICK CALLEN is shown on a tax list in West Pennsborough Twp, Cumberland Co. Again he is taxed for 1 horse, 1 cow, 2 sheep and with 30 acres of land located, and 3 acres cleared.

1771 - BEDFORD COUNTY was formed from parts of Cumberland County

1772 - NORTHUMBERLAND CO was formed - taken from Lancaster and Bedford Counties.

1772 -- November 17 - WILLIAM CALLEN and wife ELIZABETH received a Patent for land in Augusta Co, Va. (Augusta Co. land records)

1773 -- JAMES CALLAN is shown on a tax list in Hempfield Township, Bedford County. The amount of the tax assessed was 2.6 (Pa Archives Series 3, Volumn 22, page 26)

1773 -- PATRICK CALLAN is shown on the same tax list as James, in Hempfield Township, Bedford Co. The amount of the tax was 2.0.

1773 - WESTMORELAND COUNTY was formed - land being taken from Bedford Co. and extending westward to the state line.

1773 -- HUGH CALLEN was born in Westmoreland County, the son of Patrick and Sarah (Hennen) Callen. As an adult, Hugh founded the Borough of Callensburg, in Clarion Co, Pa.

1774 -- ALEXANDER CALLEN immigrated to Wilmington N.C. ("Passenger & Immigration Lists Index edited by P William Filby with Mary K Meyer)

CALLAN REVOLUTIONARY WAR SOLDIERS

1776-1778 -- WILLIAM CALLEN is listed as a Lieutenant in the 2nd Battalion 3rd Company under the command of Col. John Perry in Westmoreland Co during the Revolutionary War. (see chapter on William Callen for more details)

1778 -- PATRICK CALLEN is listed as a Private in Capt John McClelands Company to escort provisions to Fort Hand, Westmoreland Co. (see chapter on Patrick Callen for more details)

(55A) JAMES CALLAN and EDWARD CALLAN served together as Privates in Capt James Lucas' Co of the 4th Virginia Regiment of Foot, commanded by Col. Robert Lawson also known as Capt Isaac Beall's Co. They both enlisted for 3 years service on September 19, 1777. On March 4, 1778 they were stationed at Camp Valley Forge. The last record for Edward on June 6, 1778 shows he was "Claimed by another company." James records show that on July 12, 1778 he was stationed at Camp Paramus and was sick "at this point has been transferred to Capt George Wall's Co of the 4th 8th and 12th Va Regt of Foot Commanded by Col James Wood" later commanded by Col. John Nevill. In June he was listed in Capt John Steed's Co of the 4th Va Regt of Foot commanded by Col John Nevill.

1778 -- JAMES CALLIN married. The name of his wife is unknown, but this marriage is recorded in the DAR records and also in "The Callin Family History" by G.W. Callin ca 1911. (There is no chapter on the James Callin family in this book since we have not located any decendants to approve copying this information.)

1780 -- WILLIAM CALLAN held land adjacent to the McIllduff family (later shortened to Duff) in Franklin Twp, Westmoreland Co. (History of Westmoreland Co, Pennsylvania edited by George Dallas Albert 1882)

1781 May 7 -- THOMAS CALLEN son of deceased ANDREAS CALLEN married Catharina daughter of Gorg Conrad, in Lancaster Co, Pa. (Pa Archives Series 6, Volumn 6, pg 213)

1783 -- WILLIAM CALLAN is shown on a tax list in Hempfield Twp, Westmoreland Co for 200 acres, 3 horses, 3 cattle, 6 sheep (Pa Archives Series 3, Volumn 22, pg 403).

1783 -- PATRICK CALLAN is listed on a tax list in Hempfield Twp, Westmoreland Co, North District Tax 3.8 (Pa Archives Series 3, Volumn 22, pg 403).

1783 -- PATRICK CALLAN is listed on a transcript of property in Mt Pleasant Twp, Westmoreland Co for 1 horse, 1 cattle (Pa Archives Series 3, Volumn 22, pg 431)

1783 -- York Co, Pa court records show CHARLES and ALICE (COWGILL)

CALLEN receiving her inheritance from her father's will (see chapter on Charles Callen).

1783 -- Around 1783 SAMUEL CALLEN SR was born, parents unknown.

1784 -- THOMAS M CALLEN is listed in Capt Robert McCallens 1st Battalion (Pa Archives Series 6, Volumn 3, pg 457)

1785 -- WILLIAM CALLEN is named administrator for the estate of Joseph Irwin (Westmoreland Co courthouse records)

1785 Aug -- WILLIAM CALLAIN died from a fall off his horse, leaving only a verbal will - "having no relations" and left "what littel property he had to Wm Shepard and Charles McRight his apprentice Boys for said he they best deserve it also said that his Boys earnt it". (Westmoreland Co wills)

1785 -- GEORGE CALLEN taxed in Cumberland Co, Greenwood Twp for 200 acres of land. (Pa Archives Series 3, Volumn 20, pg 718)

1786 -- WILLIAM CALLEN is taxed in Franklin Twp, Westmoreland Co. (See 1780 - William held land adjacent to the McIllduff family in Franklin Twp)

1786-- PATRICK CALLEN is listed under "return of state tax" in Hempfield Twp, Westmorelad Co amount of Tax 3.9 (Pa Archives Series 3, Volumn 22, pg 506)

1786 -- PATRICK CALLEN is taxed in Mt Pleasant Twp, Westmoreland Co (Pa Archives Series 3, Volumn 22, pg 535)

1787 -- WILLIAM CALLEN SR purchased land in Mecklenburg Co, North Carolina.

1790 -- PATRICK CALLEN is the only Callen listed in Pa in the 1st U.S. census. He was living in Salem Twp, Westmoreland Co.

1790 -- WILLIAM CALLAND is shown on the census records in Mecklenburg Co, North Carolina.

1792-1794 -- HUGH and JOHN CALLEN listed in the Westmoreland Co militia (Pa Archives Series ___ Volumn ___ pg ___)

Personal property tax lists show "There were CALLENS early on in Mason County, Kentucky" as follows:

LUTHER -- 1790
THOMAS -- 1793, 1795, 1797
WILLIAM -- 1793, 1794, 1795, 1796, 1799
JAMES -- 1794, 1796
JOHN -- 1796, 1799
EDMUND -- 1797
JAMES B -- 1799

**PENNSYLVANIA IN 1729
(4 Counties)**

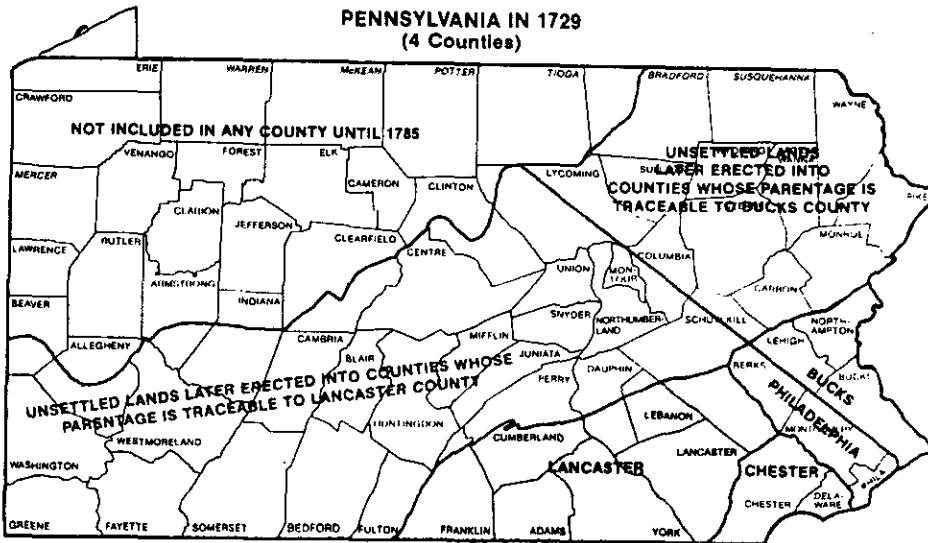

Lancaster County erected in 1729.

**PENNSYLVANIA IN 1770
(8 Counties)**

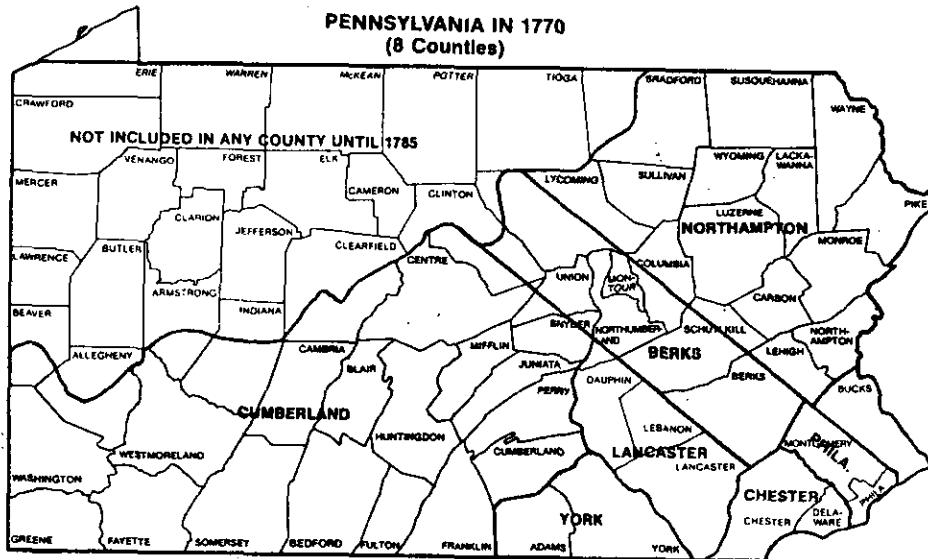

New counties: York (1749), Cumberland (1750), Berks (1752), Northampton (1752).

**PENNSYLVANIA IN 1773
(11 Counties)**

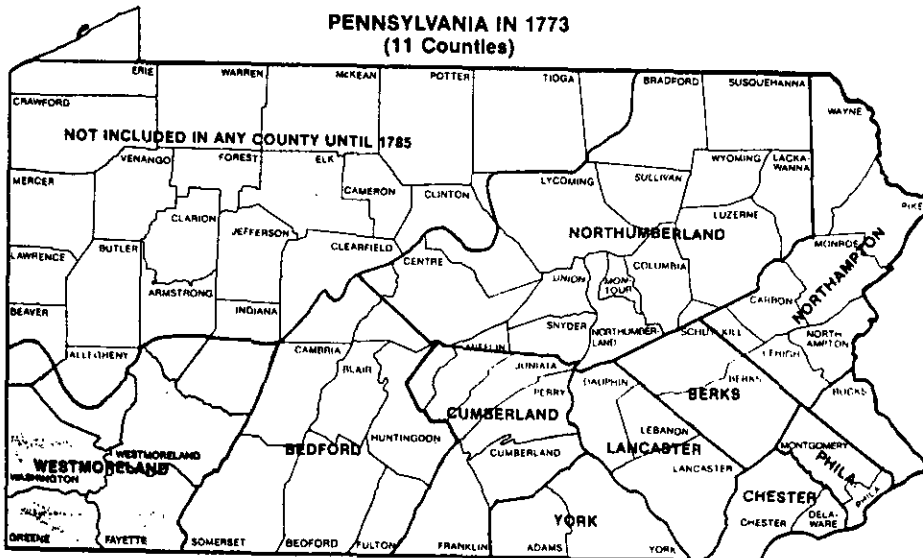

Westmoreland County formed in 1773.

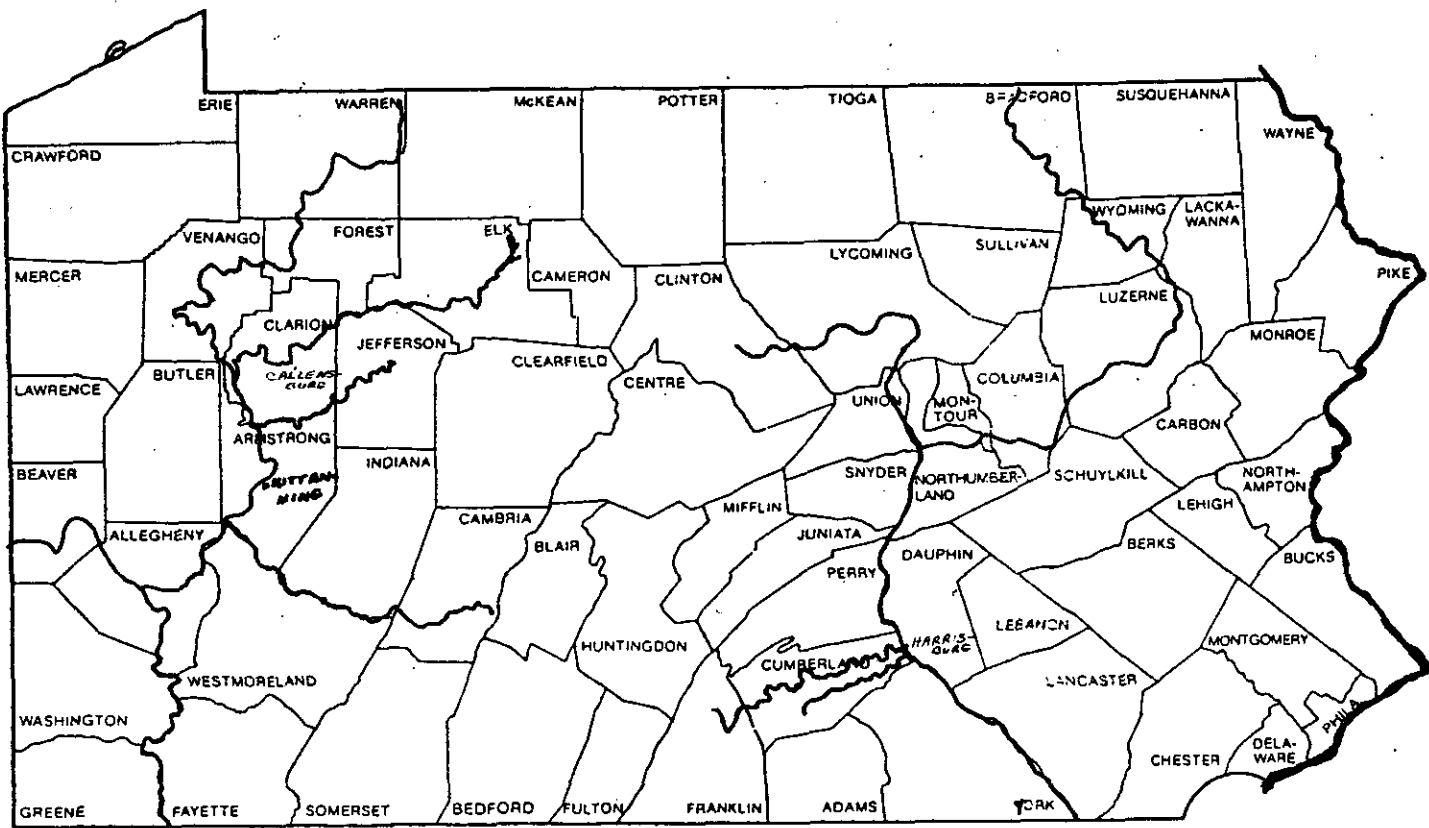



PATRICK CALLEN

1,1-PATRICK CALLEN was born around 1745-1750. We're uncertain if he was born in the Colonies or if (1)"at an early day [he] crossed the Atlantic". He was of Scotch/Irish descent, perhaps a son of John Callen who purchased land in Lancaster Co ca 1733.

(2)The first we actually hear of Patrick is in 1769 when he was taxed in Pennsborough Twp, Cumberland Co, Pa, for 1 horse, 1 cow, and 50 acres of land. (3)In 1773 Patrick was taxed for land in Hempfield Twp, Bedford Co, which later became Hempfield Twp, Westmoreland Co. (4)From Westmoreland Co land records, we learn that Patrick married SARAH HENNEN (HEANEY), sister of David Hennen and James Hennen. Sarah was also of Scotch/Irish descent.

(5)On July 21, 1778 Private Patrick Callen is listed in a Roll of detachment of Capt. John McClelland's company to escort provisions to Fort Hand. (7)"Fort Hand was erected in the spring of 1778...it was located in Westmoreland Co about 14 miles north of Hannastown, at a point described in an old manuscript as being 'about a mile south of the ford of the Kiskiminetas; and the ford was about 6 miles above the mouth of the stream.'" (8)Fort Hand was intended to protect the north border of Westmoreland Co from the raids of the Indians who lived on the upper waters of the Allegheny River." Just 3 weeks earlier, on July 7th, another "party of 9 men, under the leadership of Capt. Miller, were bringing grain to Fort Hand...and on their return were surprised by a party of Indians who lay in wait for them and killed the captain and seven others."

It may be about this same time that the story has been told about Patrick's and Sarah's identical twin daughters, their names uncertain. (35D)"During the Revolutionary War when there was much Indian activity in Westmoreland Co., the two little girls were kidnapped in an Indian raid when Patrick was away from home. The little girls were about five or six at the time, and both were taken. About 10 or 12 years later (after the Revolutionary War was over) a fur trader went into a remote Indian village, in far western Pennsylvania or Ohio, to trade with the Indians. While he was in the village he saw two young white women, about 18 years old, living with the tribe. One was the wife of a young indian brave and had a tiny baby; the other was unattached, but under the "protection" of a family in the tribe. During his visit he had no opportunity to talk with either of the women; however, after he had traded with the indians and left the village, he found one of the young women under the supplies in his canoe. She told him that she wanted to return to her white family; she said that she had talked with her sister before leaving and that her sister had wanted to remain behind with her indian family." She was returned to Patrick and Sarah Callen - apparently just a short time before they moved to Armstrong Co. The story continued, "the returned daughter had not been injured or mistreated, the family that had taken her in in the tribe had treated her as a daughter. Though she never regretted returning to her natural family, she was often restless. She was a private person, enjoying her time alone and in the woods, and she was described by her nephew, Watson, as 'special and different'. She

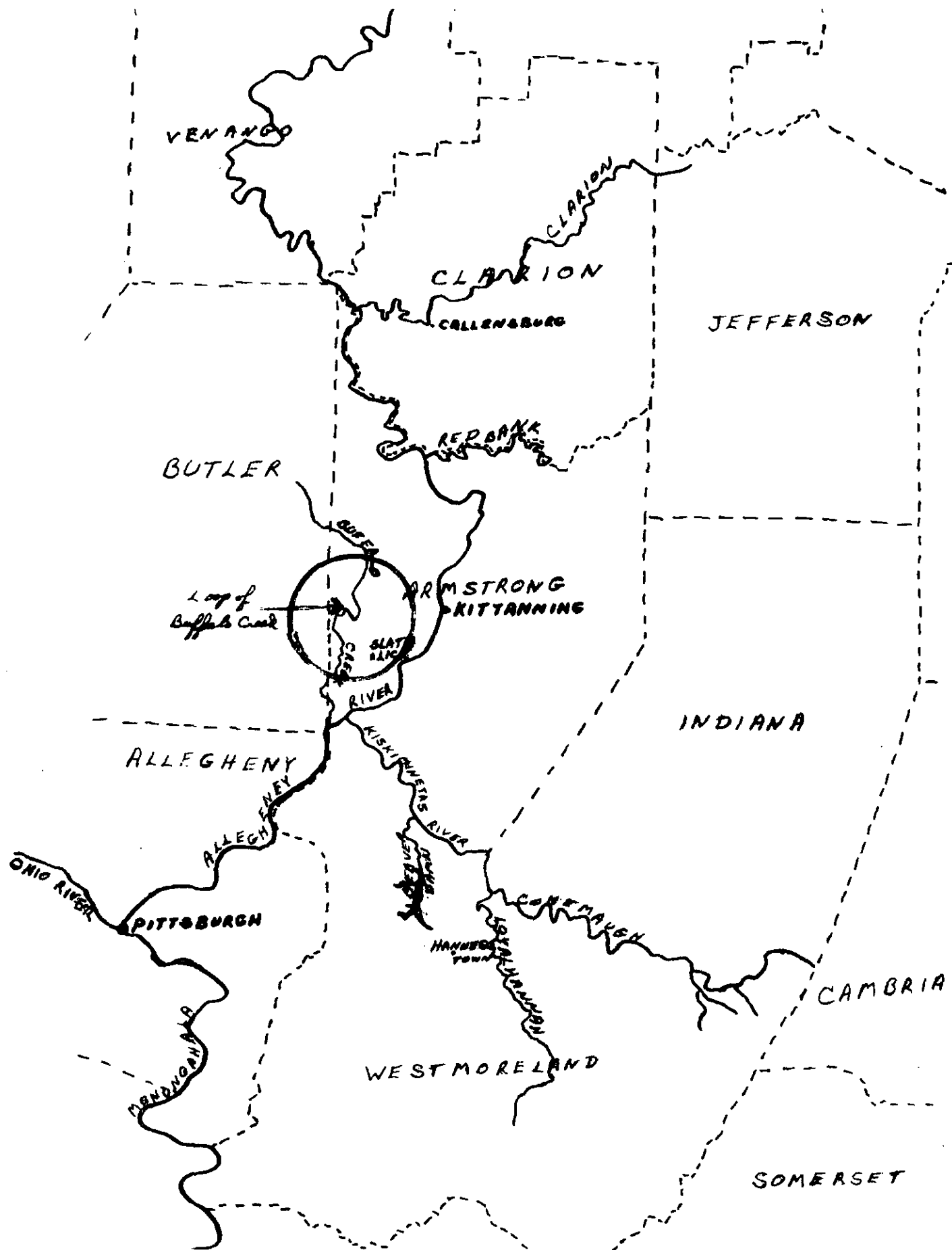

had a way with wild animals that no one, not even her family understood. She was slender, tall, and very blonde but she spent every day in the sun and the wind and she was as brown as an indian. Watson said that his grandparents just let her be herself, and did not attempt to change her, but cherished her for who she was."

(29)In 1790 the first U.S. census was taken and we find Patrick listed in Salem Township, Westmoreland Co - showing 1 male head-of-household, 2 males under 16, 3 free white females including the head-of-household.

(9)In November of 1793, while living in Westmoreland Co, Patrick made initial improvements to a tract of land located in the loop of Buffalo Creek and on the right bank (see map pg 18), which he later patented as "Downpatrick" in 1804. The property was surveyed to him in 1802 and he was accordingly assessed for it, along with 1 horse and 1 cow. (35A)In 1798 according to the notes of the assessor, his 300 acres was valued at \$316.00 and his buildings, consisting of a 16x18 loghouse and a 10x12 stable were valued at a mere \$16.00. The assessor added this note: "He must work better or he might a had a better house"!!

(9)In April 1802 Patrick moved his family to his property on Buffalo Creek, Armstrong Co. (35A)He transferred 150 acres of land on Beaver Run in Westmoreland Co. to Samuel Callen; (9)and in 1811 he conveyed 97 acres of "Downpartick" to Robert Morris and another 100 acres to John Callen. (11)In 1818 he bought back the 100 acres from John Callen at the same purchase price as he sold it.

(35A)Patrick served in the War of 1812, mustering in on March 18 with the rank of 2nd Lieutenant in the 2nd Light Dragoons. He transferred to the 26th Infantry on May 11, 1814, and was made 1st Lieutenant on May 20th. He was honorably discharged on June 15, 1815, estimating his age at that time to be around 65 years old.

(9)On November 3, 1814 Patrick is listed among the signers of a letter calling Rev John Redick to be the pastor of the Slate Lick Presbyberian Church in Armstrong Co.

In March 1825 Patrick Callen, (11)then of Toby Twp, Armstrong Co died, naming his son, Hugh, and son-in-law James Rayburn as executors of his will which is registered in Armstrong Co. The place of his burial is unknown. No more is heard of his wife Sarah; her death date was probably in early 1827(11-9), her burial place also unknown.

Children

(not necessarily by order of birth)

- 1,2 i James Callen
- ii Ann Callen
- iii Margaret Callen
- 1,3 iv Hugh Callen-b June 5, 1773
- 1,4 v Eleanor "Nellie" Callen-b 1774

1,5 vi John Callen
1,6 vii Mary Callen- m John Galbraith Sr
1,7 viii Sarah Callen-m (Elliot?) Brandon
1,8 ix David Callen-b 1792 d 1884

Will of PATRICK CALLON
(filed in Toby Twp, Armstrong Co, Penna)

(missing words and lettering, or undecipherable words and lettering are shown with an underline _____.)

In the name of God, Amen. I Patrick Callon in Armstrong County, Toby Township and state of Pennsylvania Do make and ordain this my last will and testament.

And first I commend my soul to Almighty God Who gave it, and my Body to the grave to be interred in a decent Christian like manner at the discretion of my Executors.

And as to my Worldly Estate it is my Will that it be disposed of the manner following: Viz

first it is my Will that my just debts and funeral charges be paid out of the moneys arising from the sale of my Property not herein after Bequeathed

2d It is my will that Sarah my Wife shall have a comfortable living During her Life time and I give and bequeath unto her the Whole of my Personal Property With the Whole the household Furniture and she has the Liberty of Disposing of the same at her will at her deasd and allso it is my will that she is to have the proffits of two hundred acres of land lying on Bufloe Creek in Armstrong County During her Life

3 and then it is my will that my Executors shall sell the same for the best Price that it can be Sold for and to be Equally Devided amongst the Following Legatees to Viz:

Ann Callon, Elonder Callon, David Callon, Hugh Callon sener, John Callon, Jan & James Callons Eires - that is to say that the said James Callons Eires is only to git a Childs portion to be equally Devided amongst them and the said John Callon is to git a Mear that I now own

4th and I do Will and bequeath to Mary Callon wife of Hugh Callon four Dollars -

5th and I do Will and Bequeath to my Daughter Marg___ to have an Equal Share with the Rest of my Legatees afore mentioned out of the said Land -

6th and I do Will and Bequeath to my Daughters Mary Calbreath, Sarah Brandon twenty Dollars Each to be paid out of the afore said Land when Sold

And Lastly I do hereby constitute make and ordain My son Hugh Callon & James Reburn the Executors of this my Last Will and Testament giving unto them full Power and authority to make over my Lands as above directed and execute every article and Clause hereof according to the true intent and meaning ther of

And I do hereby Revoke and disanull all former Wills by me made _____ and confirming this and no Other as my Last will and testament

In witness whereof I have here unto set my hand and Seal this 19 day Aprile A.D. 1823

(the words interlined was done Before signing)

Signed Sealed and published in Presents of us

Samuel Wilson

Mary X Callon (her mark)

Benja Coe

Patrick X Callon
(his mark) seal

State of Penns

In Pursuance of a Warrant dated 12th January 1803 there hath been Surveyed the 2nd Day of June next following to PATRICK CALLEN a certain tract of land called Downpatrick Situate in Buffaloe Township Armstrong County:

Beginning at a White oak thence by Land of SAMUEL ANDERSON, South Sixty degrees West one hundred and sixty perches to a post, thence by land of JOHN DUFFY and Land of JOHN MCKEAN South three degrees & a half East one hundred and ninety four perches to a post thence by Land of JAMES HILL North eighty six degrees and a half East thirty four perches and five tenths to a white oak, North three degrees and a half East ninety perches to a hickory north eighty six degrees and a half East one hundred and twenty five perches to a white oak. South three degrees and a half East ninety six perches to a White Oak North eight six degrees and a half East forty four perches to a white oak, South three degrees and a half East twenty perches to a White oak, North eight six degrees and a half East one hundred and twenty seven perches to a Black Oak, thence by land of JOHN SMITH Esq north three degrees and a half West ninty one perches to a hickory thence by land of DAVID HILL north twenty five degrees East one hundred and fifteen perches to a post, thence by land of ANDREW KIER north forty seven degrees and a half West one hundred and thirty perches to a post & South eighty six degrees and a half West fifty five perches to the Beginning

Containing three hundred eighty three acres ninety five perches & the allowance of Six percent for Roads & Returns into the Secretary Office the 29th June 1804 Sam'l Cochrane

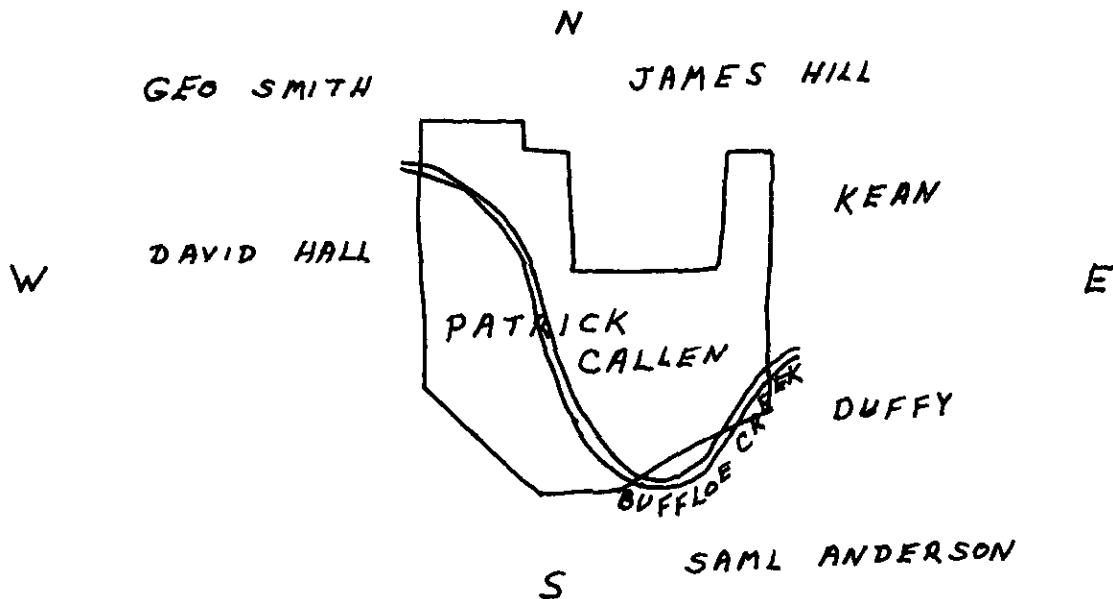

Note: N-S designations appear to be reversed from original document to map.

William Hamston.	balzer meyer Jr.
henrih Schram.	John Hawser.
Jacob Mieleisen.	Petter Ruty.
Niclos Junt.	Michal Kumb.
Saml. Hock.	Michal Stocksbelge.
Ans. Hock Jur.	Christian Jucki.
Henrig Hibley.	Aberham Jacky.
Henrig lang.	Gorg Walthauer.
Christian Bam.	John Reitman.
Phillip Studebaker.	William Beck.
Adam Studebaker.	Aberham Shefer.
Johan Eber Davis.	Lorentz Kuntz.
Petter Wannemagher.	

To The Honourable John Penn Governor in and over the Province of Pennsylvania, and Counties of Newcastle, Kent and Sussex on Delaware.

The Petition of Sundry of the Inhabitants of Westmoreland County—

Humbly Sheweth,

That your Petitioners in Consequence of the first Alarm in these Parts, did Assemble at Hanna's Town; where at their own Expence they Erected a Small Fortification as a Shelter for their Wives and Families during the Troublesome Times, and under direction of the Gentlemen of the Association Voluntarily took up Arms for the General defence of this part of the Country, 'till such Times as your Honor and the Honble Assembly were pleased to approve of our Proceedings. Your Petitioners thought themselves extremely happy and Secure, when your Honor and the Honble Assembly so considerably order'd a number of troops to be embodied for our General protection and Safety; but your Petitioners are now rendered very uneasy, by the Removal of these Troops, their Arms and Ammunition, on which your Petitioners greatest dependance lay, and which your Petitioners farther understand are ordered to the Kittaning, a place at least distant from any of the Settlements, Twenty five or Thirty Miles. Your Petitioners by being left thus exposed without Arms or Ammunition, humbly conceive themselves to be in great Danger from the Enemy, and are sorry to observe to your Honor and the Honble Assembly, that 'tis the General, as well as the humble opinion of your Petitioners, that removing the Troops to so

distant and uninhabited a part of the Province as the Kittaning, cannot answer the good Purpose for which they were intended, but appears calculated only by the advice of some who prefer their own Private Interest to the Public Welfare. Your Petitioners are farther most humbly of opinion, that some ill disposed person or persons have misrepresented our real Situation to your Honor and the Honble Assembly, otherwise we could not conceive that your Honor and the Honble Assembly would leave us exposed and defenceless in the manner we now are. Your Petitioners therefore most humbly request, that your Honor would be pleased to consider their Alarming Situation, and order such assistance as their Defenceless condition requires. And your Petitioners as in duty bound shall pray &c. &c.

William Dorrrough.	James Boveoed.
Samuel Beatty.	Robert Haslet.
James Beatty.	Joseph Shaw.
Illegible.	James Westbay.
Illegible.	John Gourle.
Illegible.	Samuel Gourle.
William Brown.	John Calhoun.
William (his [O] mark) Mcglaghen.	John Lent.
Brizela (his [X] mark) Carter.	James Dorrrough.
John Brownlee.	Stephen Groves.
Hugh Brownlee.	John addams.
Joseph Brownlee.	John hase.
Samuel McKee.	Charles Staret.
John McDonell.	rabart hase.
David McKee.	John Gothery Junier.
Robert McKee.	John Gothery Senier
James Paul.	A Dam Soot.
William McKee.	Petter Soot.
Willeam hamson.	Will'm Dickle.
John Brown.	George Dickle.
John Brown.	Moses Dickie.
Adom Morow.	David Dickie.
John Giffen.	John Crigly.
James Mckim.	Andrew McIntire.
Isaac keeth.	* Patrick Callan.
Dinnes McConal.	Chas. Foreman.
Georg Nelson.	Samuel Whitlitt.
James King.	John Holmes.
John Canan.	Joseph Winliee.
William Shaw.	Wm. Thomas.
Archebald Leach.	Joseph Caldwell.

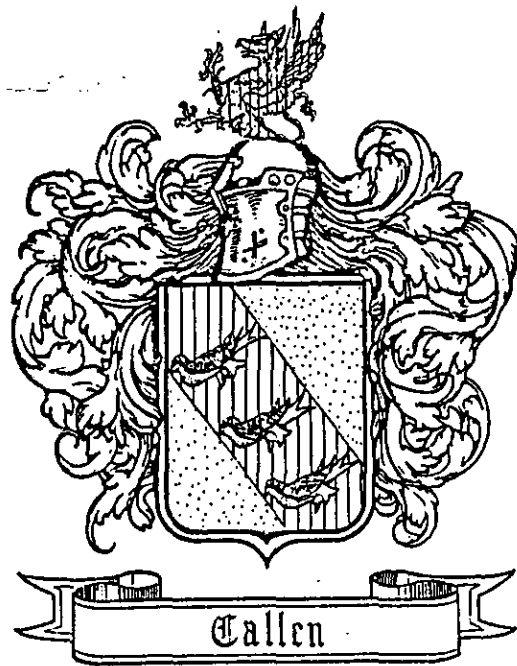

LINE OF PATRICK CALLEN - 2ND GENERATION

1,2-JAMES CALLEN/ Patrick Callen

JAMES CALLEN is believed to be the son of Patrick and Sarah (Hennen) Callen. Only two sources of information have been found on him to date:

(11)He is listed as a legatee in Patrick Callen's will (29)The 1810 census record for Toby Twp, Armstrong Co, Pa shows James and his family living in the same home as Hugh Callen Sr, founder of Callensburg. The ages of his family are:

males 0-10 yrs old= 4; 10-16= 0; 26-45= 1; over 45=1
females 0-10 yrs old= 2; 10-16= 1; 26-45= 1

1,3-HUGH CALLEN/ Patrick Callen

HUGH CALLEN, Senior was born June 5, 1773 in Westmoreland County Pennsylvania (4)probably Hempfield Township. (One source indicates that he was born in Armstrong Co - but Armstrong Co was not formed until 1800.) He was born (13)during the times "when the Revolutionary War fires were kindling". His parents were (11)Patrick and (4)Sarah (Hennen/Heaney) Callen, who were of Scotch-Irish descent.

Hugh was 15 years old when George Washington took office as the first president of the United States on April 30, 1789.

The next we hear of Hugh he is 19 years of age and is (5)listed in the Westmoreland County Militia from May 23 to June 1, again from Sept. 22 to Dec. 23 of 1792 under the command of Captain Sampson Archer. From Oct 8 to Dec 7, 1793 Hugh and John Callen are listed under the command of Captain Jeremiah Murries. Then from June 19 to Aug 12 1794 Hugh and John are under the command of Lieut. James Nicholson at Owens Island and other stations. Hugh was given an honorable discharge as a good soldier on Aug 12, 1794.

By occupation Hugh was a farmer. (9)In March of 1796 Hugh Callen settled on a tract of land (in Westmoreland Co, which became a part of Armstrong Co in 1800) and made initial improvements to this property which was located 2 or 3 miles southwest of Kittanning. It contained in its northwestern and central parts the headwaters of Pine Run, nearly 2/3 of the southwestern part of its southern half being in what is now South Buffalo Township. Also in the northwestern part were the last vestiges of an Indian village.

(9)Hugh "went sometime afterward...to get a wife, and during his absence John Cowan took possession of his cabin of which he was informed by Mrs. Rayburn (Hugh's sister "Nellie"), at whose house he stopped on his return. He said nothing except to ask for something to eat." Hugh's bride was MARY (Unknown) whose date of birth was Oct 3, 1775.

Hugh and Mary started a family very shortly after their return. It appears that the first six children born to this couple were born on the farm Hugh had prepared for his bride.

(9)"On October 29, 1805 this land was surveyed to Archibald McCall and Hugh Callen, and on May 9, 1807 the patent for 409 acres and 31 perches, called 'Last Night' was granted to them. On Feb 13, 1810, petition having been made, McCall released to Hugh 160 acres of the western side which Hugh conveyed to James Kiskadden on March 17, 1810 for \$640.00."

(29)It appears that Hugh and his wife and family moved north shortly after this land transaction, since he and James Callen (a brother) appear in the 1810 census in Toby Township. Toby Township was then a part of Armstrong County, and was later made part of Clarion County in 1839.

(13)"In 1812 Hugh bought three hundred acres and allowances which plot included the greater part of the present site of Callensburg. He settled here the same year, building a house south of Licking [a creek] very near the spot where now stands a large poplar tree. This tree grew from a twig used by Mr. Callen as a riding whip. On his return from church at Concord one Sunday he stuck the whip into the ground, and this lone poplar stands today (1883) as a monument to the piety of him who planted it."

Soon after buying this plot of land and making provisions for his family, Hugh entered the War of 1812. Hugh served as a private in that struggle and (13)is said to have received a pension for his services. (We have searched for these pension records for many years, in many places, under many variations of spellings, but haven't been able to locate them yet.)

After the War of 1812 it seems that life became as settled and carefree as pioneer life could become, with the farming to be done and the children growing. (29)Thomas, the oldest son, married and gave them their first grandchild about 1819.

(4)In 1824 Hugh's parents released land to Hugh in Fairview Township, Westmoreland Co, which Hugh eventually sold to his cousin John Hennen of Huntington Co, Pa.

(11)In 1825 Hugh's father, Patrick, died.

(13)In 1826 a survey was made of the Clarion River, with a view to locating the Pennsylvania canal. The Clarion River was at that time, (15)"called Stump Creek, and sometimes Toby's Creek--the names of two Indian trappers who went up the river with a canoe nearly every fall and trapped in the winter, returning in the spring with their canoe laden with furs and venison." (36B)In 1817 Daniel Stanard, a member of a surveying party remarked that the water sounded like a distant clarion, eventually [by 1819] the name gained favor.

With the survey of the Clarion River, which ran through Hugh's property, Hugh (15)"conceived the idea of founding a town on his farm. He thought it would be an important place along the canal, judging from the formation of the river at this point that several locks would be necessary to admit the boats up and down the canal.

CALLLENSBURG

Scale 250 Feet to an Inch

LICKING TOWNSHIP

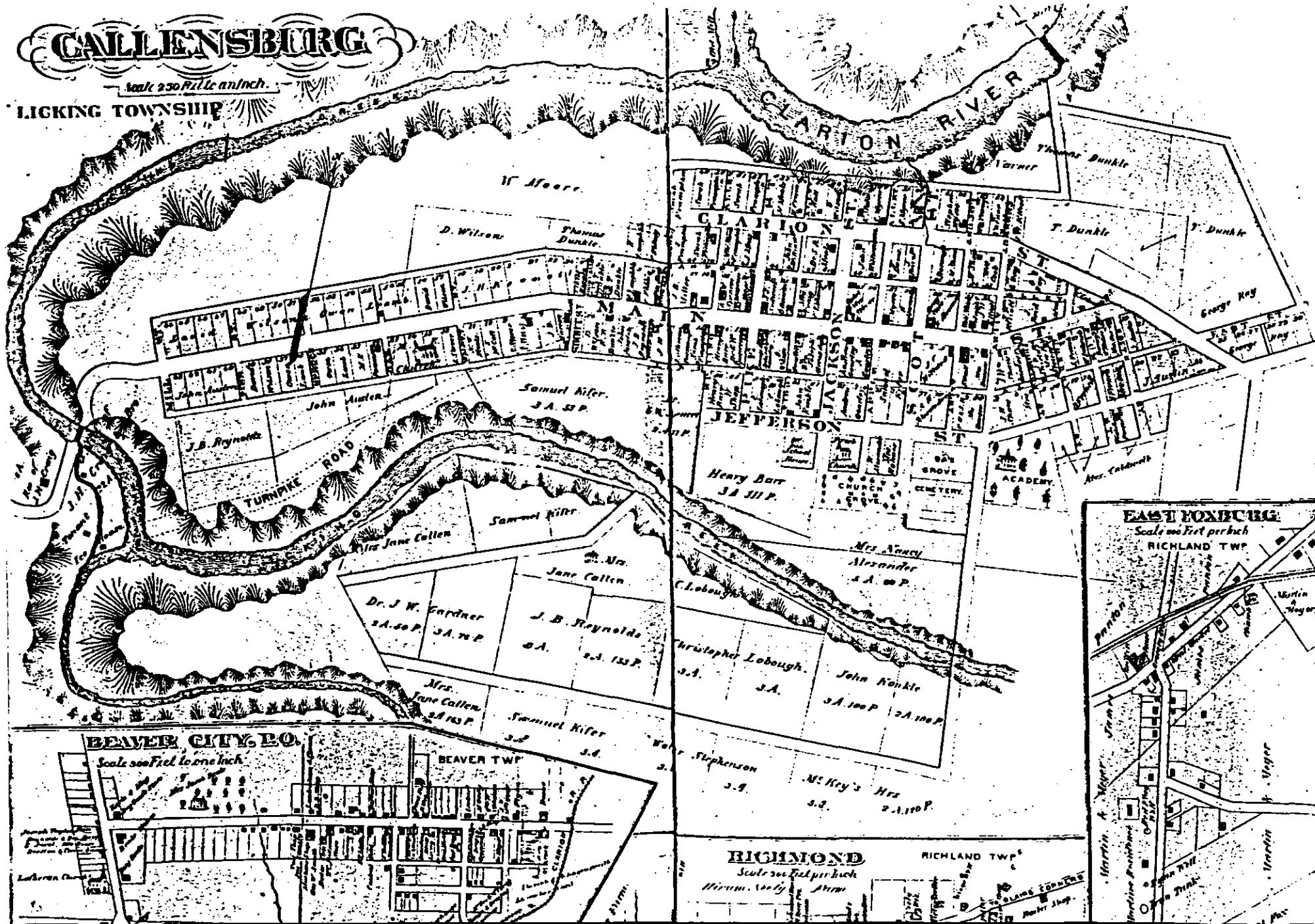

BEAVER CITY P.O.

Scale 500 Feet to one Inch

BEAVER TWP

RICHMOND

Scale 500 Feet per Inch

RICHLAND TWP

EAST FOXBURG

Scale 500 Feet per Inch

RICHLAND TWP

Beaver City P.O.
Beaver Township

CLARION RIVER
MARKET SHOP
CLARION RIVER

Martin A. Meyer
Beaver City P.O.
Beaver Township
Beaver City P.O.
Beaver Township
Beaver City P.O.
Beaver Township

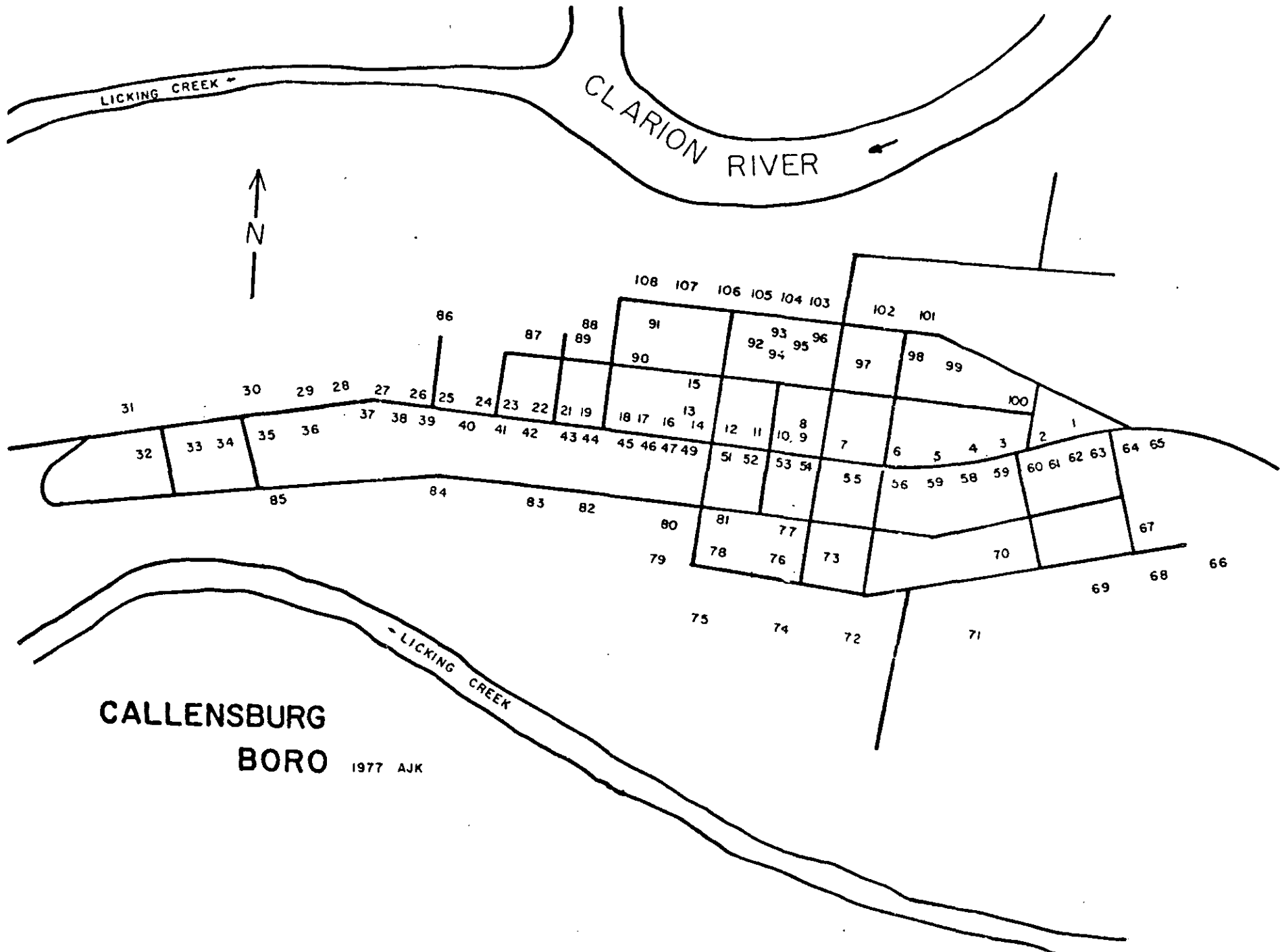

CalLENSBURG
BORO

1977 AJK

Before the town was laid out the hope of getting the canal had almost gone. Yet he did not abandon his projected town, knowing that if the canal failed - the river and a good section of country would be still left, and that at some time it would likely draw the farmers there to trade at the stores. Anyhow, he wished to sell that farm, and if he could get people to buy lots that was a sufficient reason for starting a town."

(15)"...In imagination go back...and you will see a beautiful farm here--the land beautiful, but not a house on it, and the fence poor. A few men are standing in a group, and among them is Mr Callen, with his stalwart form, and a young man 27 years old, and with a compass sighting across the fields...he has never surveyed much, but is pretty correct and thinks he can lay out the town; you inquire his name and you learn it is Sidle Lobough."

Previous to selling lots in his town, (13)"Mr Callen reserved three acres whereupon to build a Presbyterian church, this plot included the cemetery. The open lot...north of Main Street whereon the town spring rises, was excluded from the list of 'lots for sale'. That never-failing fountain of clear, pure water is a reminder of Hugh Callen's far-sightedness and public spirit. It was reserved for the public good, and to prevent it's being purchased by any private individual, he deeded it to the town."

"Hugh has the unique honor piloting the first missionary into the settlement, and blazing the way for his return with his axe."
(14)"At this time the erection of a church building was undertaken but owing to their limited means it was not finished for eight or ten years. With the characteristic spirit of the fathers they completed one corner of the building, and therein continued to hold church services and Sunday School until such a time as they were able to finish the structure. If you had been on the ground near where the present splendid building stands on a Sabbath morning...you would have seen a small group of persons devoutly seated to hear the first sermon preached by Rev Robert McGarraugh, of the Presbyterian church. He was also the first minister to preach the gospel east of the Allegheny River in Clarion County. The ladies were dressed in homespun cloth, no trails swept after them; their bonnets were substantial and large, and their shoes proportioned to their feet. The men were also comfortably dressed in homespun cloth. They all appeared clean and healthy in appearance. The ground under the shade trees and the pulpit was of the same material. Shortly after logs were used for seats, and a pulpit with a clapboard roof over it was built for the preacher. In this style they worshipped for several years during the summer, and in the winter they worshipped in the private houses of Messers. Callen, Elliott and others. In the grove communion services were held for years."

(13)"Hugh Callen was above all others indented with the first 16 years of the life of the village that he planned" and (13)"named in honor of his family". "He was not a particularly remarkable man. He was a strong man in a moral sense; an honorable man in his dealings with men; a Christian and a patriot."

(13)"He was called to Clarion in 1842, as a witness on a land case, but he never gave his testimony. While eating supper he was taken sick, and died that night, February 10, 1842, in his 69th year. His remains lie in Callensburg Cemetery."

His wife, Mary, died (16) on September 29, 1845 and is laid to rest beside her husband in the Callensburg Oak Grove Cemetery. His will is filed in Clarion County, and was administered by his sons John and Hugh, Jr.

Children

- 1, 9 i Thomas Callen-b Sept 28, 1797
- 1,10 ii John Callen-b Oct 31, 1799
- 1,11 iii Sarah Callen-b Sept 18, 1801
- 1,12 iv David Callen-b Nov 29, 1803
- 1,13 v Mary "Polly" Callen-b Feb 16, 1806
- 1,14 vi James Callen-b Mar 21, 1808
- 1,15 vii Samuel Callen-b Aug 6, 1811
- 1,16 viii Hugh Callen-b Sept 2, 1813
- 1,17 ix Watson Callen-b Feb 2, 1816



will of HUGH CALLEN SENIOR
(filed Toby Twp, Clarion Co, Penna)

In the name of God Amen I Hugh Callen Sen of Toby township, Clarion County and State of Pennsylvania being in good health of body and of sound and disposing mind and memory praised be God for the Same and being desirous to Settle my worldly affairs whilst I have Strength and capacity so to do - do make & publish this my last will and Testament - hereby revoking & making void all wills by me at any time heretofore made.

first & principally I commit my Soul into the hands of Creator who gave it - and my body to the earth to be interred in a decent like manner. And as to Such worldly estate wherewith it has pleased God intrust me I dispose of the Same as follows (viz);

Item - I will that all my just debts as Shall be by me owing at my death together with my funeral expences and all charges touching the proving of or otherwise concerning this my will Shall in the first place out of my personal estate and effects be fully paid and Satisfied and from and after payment thereof & subject thereto I give and bequeath unto my beloved wife Mary Callen all my household and kitchen furniture together with one Horse Saddle and bridle & one milk cow And to hold & have the disposel of the dwelling house we now occupy dureing her lifetime

Item - I give & bequeath unto my Neace Nancy Jane Callen Daughter of David Callen one horse Saddle and bridle worth fifty dollars also one milk cow worth twelve dollars and one bed and bedstead worth twenty dollars

Item - it is my will that all the remaining part of my personal property together with my real estate property Shall be indifferently appraised and Sold and out of the proceeds of the aforesaid Sales or in proportion there to I give and bequeath unto my oldest Son Thomas Callen five hundred dollars

Item - I give and bequeath unto my Second Son John Callen five hundred dollars

Item - I give & bequeath unto my daughter Sarah Callen wife of Samuel Wilson three hundred dollars

Item - I give and bequeath to the legal heirs of my daughter Polly Callen decd wife of Michael Reighart three hundred dollars

Item - I give & bequeath unto my Son - David Callen three hundred dollars

Item - I give & bequeath unto my Son Samuel Callen two hundred dollars

Item - I give and bequeath unto my Son James Callen two hundred dollars

Item - I give & bequeath unto my Son Hugh Callen three hundred dollars

Item - I give & bequeath unto my Son Watson Callen three hundred dollars

Item - it is also my will and desire that my two Sons Hugh and Watson Shall hold and have the benefit of my farm I now reside on for the term of three years from the date of this my will free of any charge & as much longer as I myself & wife Mary live thereafter

Item - And lastly my express will and meaning is - and I do hereby order and appoint that if any differance dispute question or controversy Shall be moved arise or happen concerning any gift or bequest in this my will given & bequeathed expressed or contained that then no Suit or Suits in law or equity or otherwise Shall be brought commenced or prosecuted for and concerning the Same but the Same Shall be referred wholly to the award order and determination

of my friends Christian Meyers associate Judge of Clarion County State of Penna and Henry Alexander of Callensburg County & State aforesaid and what they Shall order - direct and determin therein Shall be binding and conclusve to all & every person & persons therein concerned

And I ordain and appoint my Sons John Callen and Hugh Callen executors of this my last will and testament

In witness whereof I have hereunto Set my hand and Seal this twentieth day of January in the Year of our Lord one thousand eight hundred & forty one
Hugh Callen (Sen)

Seal

Signed Sealed published and declared by the above named Hugh Callen (Sen) to be his Last will and testament in the presence of us who at his request and in his presence have Subscribed our names as witnesses thereunto

Paul Neely; Joseph Alexander; Henry Alexander

1,4-ELEANOR CALLEN/ Patrick Callen

ELEANOR CALLEN (called (11)Elondor and (10)Nellie) was born in (12)1774 in Westmoreland Co, Pa. She was the daughter of Patrick and Sarah (Hennen) Callen. She married (10)JAMES RAYBURN who was born in 1769 in Ligonier Valley, Pa son of a Scotch emigrant. Their marriage date is uncertain, but probably (9)around 1797. (10)James Rayburn moved to North Buffalo Township in now Armstrong Co, Pa about 1797 with Patrick Callen, his father-in-law. James was a Democrat and an active member of the Seceder (United Presbyterian) church. (12)He died in 1837, Nellie died in 1850, both are buried in the Slate Lick United Presbyterian Church Cemetery, North Buffalo Twp.

Children

- 1,18 i James Rayburn-b Oct 26, 1801
ii Mary Rayburn-m Mr. BRANDON
iii Callen Rayburn
1,19 iv Matthew Rayburn-b May 2, 1808

(The "History of Armstrong Co, Penna" says there were 7 children born to Eleanor and James, 6 that grew to adulthood, the other 3 children's names are not known at this time)

1,5-JOHN CALLEN/ Patrick Callen

(5)JOHN CALLEN is believed to be the son of Patrick and Sarah (Hennen) Callen. The PA Archives shows that John served with Hugh Callen in the Westmoreland Co Militia for the state of Pa. He served during 1793 to 1794 under the command of Lieut. James Nicholson. Nothing else is known about this man.

1,6-MARY CALLEN/ Patrick Callen

(11)POLLY CALLEN, (Polly being a nickname for Mary), was the daughter of Patrick and Sarah (Hennen) Callen and was born sometime between 1775-1795. (18)About 1815 she became the second wife of JOHN GALBRAITH, Sr. b 1780, who's first wife, Rebecca Smith, died shortly after the birth of her second child. John Galbraith Sr was the only son of a Scotch-Irish emigrant who fought in the Revolutionary War and was listed as missing in action, never to be heard of again. John Sr and Polly settled in Jefferson County where they established their home in Beaver Township.

Children

- i S/S John Galbraith
- ii S/S Joseph Galbraith-b Apr 20, 1805 d Mar 8, 1885

POLLY's children

(not necessarily in order of birth)

- i Sarah Galbraith- m d "at an advanced age"
- ii Eliza Galbraith- m d "in middle life"
- iii Robert Galbraith
- iv Mary Galbraith
- 1,20 v James C Galbraith-

1,7-SARAH CALLEN/ Patrick Callen

SARAH CALLEN was the daughter of Patrick and Sarah (Hennen) Callen. According to Patrick's will she married Mr. Brandon - we believe he might have been ELLIOT BRANDON of Venango Co, Pa., but no proof at this time.

1,8-DAVID CALLEN/ Patrick Callen

We believe this man, DAVID CALLEN, to be the son of Patrick and Sarah (Hennen) Callen since he is listed among the "Legatees" in Patrick's will, and also mentioned in Hugh Sr's will. (30)He was born around 1792/1793 in Westmoreland Co, Pa.

David served in the War of 1812. (13)"In the autumn, 'seeding time' of 1812 a draft for a six months' term was made on the settlements south of the river. On the 25th of September, John, Alexander, Thomas, and James Guthrie...and a few others met at Philip Clover, Sr's house, and after having made a temporary organization, with John Guthrie as captain, left for the south. Judge Clover says: "It was a sad day for all. I well remember, as a boy the morning they started...When they were all ready to go they discharged their guns into a tree top that stood near by, and amid many tears they marched away." On their way they were joined by many others, and then proceeded to Pittsburgh. They encamped on the site of Allegheny, then a mere thicket, with one hut on it, and on October 2 a permanent organization was effected. The company was incorporated with the 1st Regiment Pennsylvania militia, John Frees, colonel; Second Brigade, commanded by General Crooks..." Those from Armstrong Co, nearly, if not quite all, came from north of the Redbank" (The Redbank is the river that divides the counties of Armstrong and Clarion) ...listed is David Callen.

(30)"...this consolidation was on the day of muster, at Dunlap's Plains, near Pittsburg, on the 2d day of October, 1812...From Pittsburg they marched, under command of General Crooks, to Sandusky Plains (located in north western Ohio) where they united with the troops under General Harrison, said General Harrison assuming the command. From Sandusky Plains they marched to the rapids on the Maumee River where they laid off and constructed the fort known as Fort Meigs, and that during the entire term of his service he was working upon said fort."

(30)David was honorably discharged at Fort Meigs, Ohio on April 2, 1813. He apparently returned to his home in Pennsylvania, for his pension papers state that on July 15, 1816, David married ELIZABETH FLEMING, in Westmoreland Co. (37A)Elizabeth was born in 1794, the daughter of James Fleming. "David Callen and Samuel Holler married two Fleming sisters, Elizabeth and Jane, respectively. All of David Callen's and Samuel Holler's children were born in Pennsylvania. The two families emigrated together to around Peoria, Ill. and most of their [grand]children were born at or near Sparland, Ill. a little town just above Peoria on the Illinois River..."

The next we hear of David, he was 57 years old, and living in Marshall County, Illinois - date October 29, 1850 - where he made application for Bounty Land as a soldier having been engaged in the Military Service. He was subsequently awarded two Bounty Land grants, one for 80 acres.

(37A)Elizabeth died in 1864. (30)In 1871 David was living in Fairfield, Wayne Co, Ill, and he applied and received a pension amounting to \$8.00 a month.

On December 28th, 1874 David, then living in Corning, Adams Co, Iowa, discovered upon leaving that he had misplaced his pension papers. So on March 15, 1875, then a resident of Salina, Salina Co, Kansas, David applied for replacement papers.

David died December 7, 1884 in Zif, Ill. aged almost 92 years old. (37A)"Samuel Holler and his wife are buried near Sparland and Elizabeth Callen is also buried there, while David Callen is buried at Fairfield, Ill. where his son James is also buried."

Children (all born in Pennsylvania)

- i Solomon Callen-b
- 1,21 ii James Fleming Callen-b ca 1817
- 1,22 iii William Callen-b May 26, 1821
- iv Ellen Callen-b ca 1823 d 1902-1903
 - m DEXTER HASKELL
- 1,23 v Joseph Callen-b Aug 27, 1829
- 1,24 vi Arthur Fleming Callen-b May 14, 1832
- vii Sarah-"was killed in some kind of accident"
 - m ISAAC HAMILTON
- viii Nancy Jane Callen-b ca 1835 in Penna d ca 1905

We're uncertain if there is a Nancy Jane - or a Nancy and a Jane.

LINE OF PATRICK CALLEN - 3RD GENERATION

1,9-THOMAS CALLEN/ Hugh Sr/ Patrick Callen

THOMAS CALLEN was born on (1)September 28, 1797 in Westmoreland Co, Pa, in an area which later became part of Armstrong Co, when that county was formed in 1800. Thomas was the oldest son of Mary and Hugh Callen, Sr. founder of Callensburg, Pa.

(29)In 1820 Thomas was listed in the U.S. census records for the first time as the head-of-the-household and living in Toby Township, Armstrong Co. By that time he had married (29-6)MARY "ANN" JACKSON (12)who was born 1794.

(29)In 1830 Thomas was listed in the census records living in Perry Twp, Armstrong Co.

(19)In 1833 Thomas settled in Jefferson Co. (13)"Thomas and [his brother] John were known throughout Jefferson and Elk Counties as great hunters, those regions being then an uninhabited wilderness." (22)In those days "hunters were paid for killing animals that were considered predators by the early settlers. Cows, pigs, chickens and other farm animals were necessary for the survival of life and the pioneers wanted no wild animals feasting on the domestic animals...

"Jefferson County was obligated by action of the State Legislature to pay a bounty on wolves, panther, fox and wild cats or "bob" cats. Bounty for wolves and panthers was set at \$12.00, cats brought \$1.00 each and full grown fox was worth thirty-seven and one-half cents...In a day when a man's average wages could be pegged at fifty cents, a bounty of twelve dollars was big money and sometimes the only cash money a family could count on.

"To collect the bounty, a person had to present the full hide of an animal after which the ears were cut off and the hide returned for the owner to sell for whatever he could get for it.

"Kate Scott in her county history attributes the payment of the first panther bounty (\$12.00) to Thomas Callen, but the court house records would indicate that William Long should be given credit...It might also be noted that a bounty was also paid on crows and squirrels because they were so plentiful and crows were difficult to raise in the wilderness. Crows brought three cents each and squirrels brought one and one-half cents."

(19)Eldred Twp was organized in Jefferson Co in 1836 and was named after Nathaniel B Eldred the president judge of the district. With the formation of this new township, the first election was held and Thomas Callen was elected "Overseer-of-the-Poor". "The Overseer-of-the-Poor was to find and list all the names of those children whose parents were unable to pay for their education, including schoolbooks, and stationery. They were to keep records of all costs for these children's education and levy and collect, in the same way as road taxes were levied and collected, the amount of money needed from their townships, boroughs, wards, or districts, plus 5% for their trouble."

(19)At the September 16th township session of 1836 petition was made for a road from Mill Creek (a stream three or four miles from Sigel), near John Wilson's, to Maize Gap on the Clarion River. On May 10, 1837 the petition was read and approved with Thomas Callen named as the overseer of the road construction of this project.

(20)About September of 1846 Thomas Callen, then of Sigel, Eldred Twp, Jefferson Co, Pa died without leaving a will. His estate was settled by his oldest son Jackson and filed on September 25, 1846.

(29)After the death of Thomas, his wife Ann and her children (with the exception of Hugh) moved to Kellersburg, Madison Twp, Armstrong Co and lived next door to a man presumed to be her younger brother. He was Hugh C Jackson, and one of his sons was named Callen M. The neighbors must have enjoyed having Jackson Callen and Callen Jackson living so close to each other.

(18)Ann (Jackson) Callen died in 1879, approximately age 85, and is buried in Kellersburg, Pa beside the Evengelical Missionary Church along with several of her children and grandchildren. Although Thomas' name is inscribed on her tombstone, he may be buried in Sigel in an unmarked grave.

Children

- 1,25 i Jackson Callen-b ca 1819
- 1,26 ii Hugh Callen-b May 8, 1822
- iii Isabella J Callen-b 1826 buried in Kellersburg, Pa
- iv Mary A Callen-b 1828 possibly m WM JACKSON 1810-1859
- 1,27 v John Callen-b ca 1830
- vi Harrison Callen-b ca 1832
- vii Lucinda Callen-b Mar 8, 1837 possibly m Mr. DUNCAN
- 1,28 viii Josiah J Callen-b Mar 1, 1840

1,10-JOHN CALLEN/ Hugh Sr/ Patrick Callen

JOHN CALLEN was born (1)Oct 31, 1799 in Westmoreland Co, Pa. He was (13)"known throughtout Jefferson and Elk counties as a great hunter, those regions being then an uninhabited wilderness."

(35K)"I have a Carving Set, made by a John Callen, son of Hugh. A knife and fork. The steel came from England and the handles are Buckhorn. John Callen killed the deer from which he obtained the horns used for the handles."

(29)Pa census records seem to indicate that John moved from area to area:

- 1820 Butler Twp, Butler Co
- 1830 Clarion Twp, Armstrong Co
- 1840 Monroe Twp, Armstrong Co - shown as married -no children
- 1850 Clarion Twp, Clarion Co shows wifes name as Elizabeth, they had two daughters, also living with them is Isabella Kiskadin

We believe that John's wife was ELIZABETH KISKADDEN (29) born 1803 (11) daughter of Thomas Kiskadden of Buffalo Twp, Armstrong Co who died April 27, 1839 leaving unmarried daughters Elizabeth, Isabella, and Mary. Thomas Kiskadden's will was witnessed by James & Matthew Rayburn, cousins of John Callen.

John died October 7, 1866 near Clarion, Clarion Co, Pa place of burial unknown. (28) A notation in a family Bible shows Elizabeth died March 6, 1863 - we are not sure if she is John's wife Elizabeth since we have been unable to find any other death record.

Children

- i M.J. (female)-b 1840
- ii M.M. (female)-b 1847

1,11-SARAH CALLEN/ Hugh Sr/ Patrick Callen

SARAH CALLEN was born (1) September 18, 1801 in Armstrong Co, Pa. She married SAMUEL WILSON who was born ca 1795 and died (9) between 1850-1860

(29) It appears that Sarah lived in Callensburg all her life with her family. She died between 1870-1887, and is believed to be buried in the Callensburg Cemetery.

Children

- i Mary Wilson-b ca 1824
- ii Margaret Wilson-b ca 1826
- iii Sarah Wilson-b ca 1828
- 1,29 iv Hugh Callen Wilson-b 1830
- v Amanda Wilson-b ca 1839
- vi John H Wilson-b ca 1841

1,12-DAVID CALLEN/ Hugh Sr/ Patrick Callen

DAVID CALLEN was born November 29, 1803 in Armstrong County, Pa. He married (23-24) MARY WEIR, who was born (29) June 1815 probably in Wilmington, Delaware. She was the daughter of Capt John and Jane (Roney) Weir.

Mary's family moved to Butler Co in 1819 and settled on a tract of land located on the road between Freeport and Butler, which Mr. Weir named "Disappointment Farm". Mary's sister, Sophia Weir married Robert Morris, (see land transaction between Patrick Callen and a Robert Morris 1811).

(29) David and Mary settled in Freeport, Armstrong Co, Pa around or before 1840. (11) On April 4, 1848 David bought "in-lot No. 184" for \$35.00 - on January 17, 1849 he sold lot no 184 to James B Atkinson for \$100.00 - not a bad profit for 1 years time.

(11) David died in February or March of 1850, aged only 47. (29) Mary (Weir) Callen continued to live in Freeport until after the 1870 census. She is shown on the 1900 census records in S. Buffalo Twp, Armstrong Co. Her nephew John Weir was living in the same home at that time.

Will of DAVID CALLEN
(filed Freeport Borough, Armstrong Co, Pa)

I David Callen of the Borough of Freeport, Armstrong County, & State of Pennsylvania, do make and publish this my last will and Testament, hereby revoking and making void all former wills by me at any time heretofore made.

And first I direct that my body be decently interred in the burying ground of the Borough aforesaid according to the rites and ceremonies of the Church of which I am a member and that my funeral be conducted in a manner corresponding with My estate and situation in life.

And as to such worldly estate as it hath pleased God to intrust me with, I dispose of the Same as follows:

First - I direct that all my funeral expences be paid as soon after my decease as possible out of the first moneys that shall come into the hands of my executors, and that all outstanding debts, due me, shall be collected and gathered in as soon as practicable, and also that all the just debts which I owe be discharged by My Executors in a manner least injurious to my Estate.

Secondly - I will and bequeath the remainder of my estate of whatsoever name or nature the Same may be to my beloved wife Mary Callen -

Thirdly - I hereby appoint and ordain my wife Mary Callen, and my esteemed friend John Weir Jr the executors of this my last will and testament

In testimony whereof I have hereunto Set my hand and seal this the twenty-third day of February in the year of our Lord one thousand Eight hundred and fifty.

Witnessed by us in the presence of the Testator and in the presence of each other.
The words "revoking" & "be" interlined before signing

David Callen seal

Wm F Kean; John Woods

1,13-MARY CALLEN/ Hugh Sr/ Patrick Callen
MARY "POLLY" CALLEN was born February 16, 1806 in "Last Night" Armstrong Co, Pa. (11)She married MICHAEL REICHART born ca 1806, (29-17)it appears they had at least 7 children. Polly died (12)June 9, 1839 and is buried beside her parents in the Callensburg Oak Grove Cemetery. (17)Michael Reichart married next to Elizabeth (unknown) and had at least 6 children by that marriage.

- Children who appear to be Polly's
- i Elmira Reichart-b
 - ii Sarah Reichart-b m JAS McCALL
 - iii Mary Reichart-b m JOHN STEWARD
 - 1,30 iv Eliza Reichart-b m WILLIAM P LASH
 - v Caroline Reichart-b m C H POLLOCK
 - vi Hugh Callen Reichart-b
 - vii Martha Reichart-b ca 1834 possibly died before 1875

1,14-JAMES CALLEN/ Hugh Sr/ Patrick Callen
 JAMES CALLEN was born on March 21, 1808 in "Last Night" Armstrong Co, Pa. Last Night was the patented name of a farm owned by his father located near Kittanning.

(10) James married MARY WILSON on June 30, 1836, but had no children by that marriage. After her death James married ELIZA W. (LAUGHLIN) DIXON of Juniata Co, Pa, who had first married William Dixon by whom she had 3 children. Eliza was born May 14, 1811.

James and Eliza were married in Clarion county and settled on a farm in Piney Twp. "They were faithful members of the Presbyterian Church and were highly esteemed by all who know them." James was a Democrat in politics, and a farmer by occupation.

Eliza died January 22, 1874 at the age of sixty-three years. James died in 1893, at the age of eighty-three. Both are buried in the Callensburg Cemetery. James headstone has been broken off.

Children

- S/D Nancy J Dixon- m ANDREW J REECE of Piney Twp
- S/S John L Dixon- Apr 15, 1852 (16 yrs 3 mo)
buried Callensburg Cem
- 1,31 S/S James A Dixon-b 1838 d 1919 m LAVINA J (1844-1966)
 - i Thomas Jefferson Callen-b Feb 02, 1842
 - ii Mary A Callen- m AUGUSTUS ABLE a merchant of Falls Creek, Jeff Co
 - iii Sarah E Callen-b Aug 7, 1846 d Oct 1, 1880
 - iv William H Callen-b Nov 27, 1848 d Nov 29, 1878
 - v David R Callen-b Dec 6, 1852 d Mar 3, 1874
buried Callensburg Cem

1,15-SAMUEL CALLEN/ Hugh Sr/ Patrick Callen
 SAMUEL CALLEN was born August 6, 1811 in Toby Twp, Armstrong Co, Pa. (29) He married ELIZABETH (unknown) who was born July 31, 1811 in (6) Lancaster Co, Pa. By occupation he was a farmer.

(28) Samuel died March 1879 and (13) is buried near Reidsburg, Pa. Elizabeth died on her 91st birthday July 31, 1902.

Children

- i Emily Callen-b ca 1840
- 1,32 ii Hugh Worthington Callen-b ca 1843

- iii Malinda Callen-b Aug 1847
- iv Lucy Callen-b ca 1849
- v Nancy Callen-b Dec 1852
- vi Ella Callen-b ca 1856 must have died young

obituary of MRS. ELIZA CALLEN
(from Clarion Democrat, Aug 7, 1902)

Mrs. Eliza Callen died at her residence near Kingsville on July 31, 1902 aged 91 years. Her 91st birthday came on the day of her death.

Mother Callen, as she was familiarly called, was one of the oldest and most highly respected citizens of the county. She came to the county in early life when wilderness was the rule rather than cleared land.

Deceased was a firm believer in, and an intelligent defender of the doctrines of the New Testament interpreted by the Baptist church of which she has long been a consistent and faithful member.

Appropriate funeral services were conducted at her late residence, by Rev W.B. Purdy, and the large congregation present indicated the high esteem in which she was held in the community.

1,16-HUGH CALLEN JR/ Hugh Sr/ Patrick Callen

HUGH CALLEN JR was born September 2, 1813 in Toby Twp, Armstrong Co, Pa. (13)"on the old Callen homestead, across Licking".

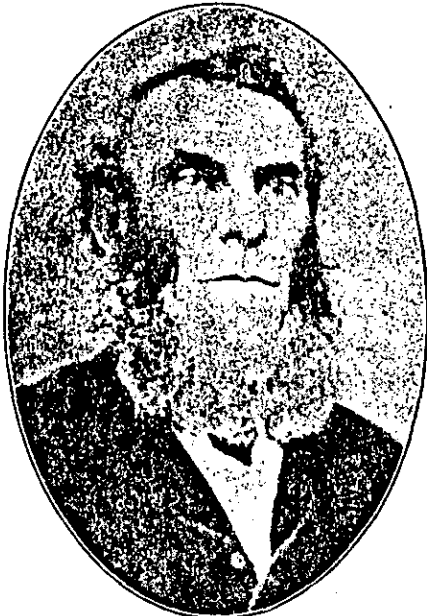

HUGH CALLEN, JR.

(6)In 1842 he married JANE E ELLIOT who was born Jan 3, 1816. By occupation he was a farmer, and made his permanent residence on his father's farm.

(13)"He was a man of sterling qualities, of great stability of character, firm in his convictions, a faithful friend, and an unpretentious and exemplary Christian. All who knew him respected him, and now his memory is revered."

Hugh died March 17, 1881. His headstone reads "Weep not he is at rest How desolate our home bereft of thee". (29)In 1900 Jane was living in Clarion Co at the home of her daughter. Jane died August 11, 1908. Both are buried in the Callensburg Cemetery.

Children

- 1,33 i Sarah Lovenia Callen-b May 29, 1841
- ii Andrew White Callen-b ca 1848 shown on 1850 & 1860 census no other mention is ever made of him-probably died young

obituary of JANE E (ELLIOT) CALLEN
(Clarion County, Pa)

Jane E Callen was born in Westmoreland Co, Pa, Jan 3, 1816, and died in Callensburg, Pa Aug 11, 1908, in her 93rd year. Deceased married Hugh Callen in 1842. Of this union one daughter was born, Mrs. Ross Nichols, of Callensburg, who still survives her parents.

Deceased was a lady of marked piety, one whose labors of love and devotion to the cause of Christ will continue in this community through time. In early life she united with the church of her choice, therein proved faithful, abounding in labors until she fell sweetly to sleep to awake in the church triumphant.

Hugh Callen, husband of the deceased preceeded her to the heavenly home March 17, 1881.

Hugh Callen Sr. father-in-law of the deceased together with the entire family figured prominently in the early history of this community. He was born in 1773 when the Revolutionary fires were kindling. He served as a private soldier in the War of 1812. He donated the Presbyterian denomination the present site for their church and buring ground. At or near the same time, 1825, he laid out the village of Callensburg and named it in honor of the family.

Hugh Callen, Sr. has the unique honor piloting the first missionary into the settlement, and blazing the way for his return with his axe. At this time the erection of a church building was undertaken but owing to their characteristic spirit of the fathers, they completed the corner of the building and therein continued to hold services church and school until such time as they were able to finish the structure.

With the decease of Jane E Callen the immediate family passes away but their works remain a witness of how well they wrought.

Funeral services were conducted by the Rev M.B. Riley from the Presbyterian church and the remains were laid to rest by the side of her husband to await the reward of the faithful.

Will OF HUGH CALLEN JR
(filed Clarion County, Pennsylvania)

In the name of God Amen

I Hugh Callen of the Township of Licking, County of Clarion, State of Pennsylvania Yeoman being of sound and disposing mind memory and understanding and considering the uncertainty of life do make and publish this my last will and Testament hereby revoking and making void all other wills by me at any time heretofore made. As to such estate as it hath pleased God to intrust me with I dispose of the same as follows viz:

I direct that my just debts, funeral expenses and cost of settling my estate be paid out of my personal Effects and the remainder if any including my household goods, I give and bequeath to my beloved wife Jane E Callen absolute.

I give and devise to my said wife Jane E Callen all the real estate that I may possess at the time of my decease or that may fall to my estate after my decease during her natural life if she shall so long remain my widow. Where by death or otherwise my said wife Jane E Callen shall cease to be my widow I give and devise all my real estate wherever located aforesaid to my daughter Sarah intermarried with Ross Nickle.

I do hereby constitute and appoint my friend and neighbor Alexander Colwell of the Township aforesaid Sole Executor of this my last will and testament.

In Witness Whereof I Hugh Callen the Testator have to this my will written on this sheet of paper set my hand and seal the fourteenth day of March AD one thousand eight hundred and eighty one.

Hugh Callen seal

Signed sealed published and declared by the above named Hugh Callen as and for his last Will and testament in the presence of us who have hereunto subscribed our names at his request as witnesses direct in the presence of the said testator and of each other.

William McFarland E.M. Murray J.C. Waddle

1,17-WATSON CALLEN/ Hugh Sr/ Patrick Callen

WATSON CALLEN was born February 2, 1816 in Toby Twp, Armstrong Co, Pa, (6)he married JANE SHADLE born February 12, 1820. Jane was the daughter of (35B)Daniel and Elizabeth (Fox) Shadle who moved to Monroe Twp, Armstrong Co in 1832 or 1833. This area of Armstrong Co became Clarion Co in 1840

By occupation Watson was (29)an inn keeper and farmer. He died sometime between 1870-1880 in Brockwayville, Jefferson Co, Pa. His wife Jane died July 21, 1888. Both are buried in the Wildwood Cemetery in Brockwayville, Pa, in unmarked graves.

Children

- 1,34 i Mary Callen-b ca 1840 in Callensburg, Pa
- 1,35 ii John H Callen-b Jul 6, 1842
- iii Nancy M Callen-b Mar 1844 d Sept 9, 1845
1 year, 5 mo, 15 days old buried Callensburg
- iv David Callen-b ca 1846 apparently died young
- 1,36 v Alvin Cummings Callen-b May 13, 1849
- vi Howi (Howard?) Callen-b ca 1849 apparently died young
- vii infant son-b April 10, 1851 died May 28, 1851
1 month, 18 days old buried Callensburg

- 1,37 viii Sarah Ann Callen-b Apr 25, 1852
- 1,38 ix Amanda Jane Callen-b ca 1854
- 1,39 x Matilde Callen-b ca 1856
- 1,40 xi Elizabeth Alice Callen-b ca 1858
- 1,41 xii Louise Emma Callen-b 1861

obituary of MRS JANE (SHADLE) CALLEN
(newspaper??)

Mrs. Jane Callen died at Forestville, on Saturday, July 21, after a long sickness, at the age of 68 years.

Jane Shadle was born in Huntington county, this state, February 12, 1820. When she was 12 years old her parents came to Clarion county, and settled in the neighborhood. She married Watson Callen in 1840, and to them were born five sons and seven daughters, of whom two sons and five daughters are living.

For more than five years Mrs. Callen had been a sufferer from a complication of paralysis, spinal disease and rheumatism.

Soon after her marriage she united with the Presbyterian church at Callensburg, and since that time her aim was to lead a christian life. Of late she longed to depart, and escape from her sufferings and be at rest. The funeral was held in the Wildwood cemetery on Monday.

1,18-JAMES RAYBURN/ Eleanor Callen/ Patrick Callen

JAMES RAYBURN was born October 26, 1801. (23)James' occupation was farming.

(23)He was a Jeffersonian Democrat, always active in his party, frequently representing his district in county democratic conventions. Although he never sought public office he was frequently elected and served in the office of Justice of the Peace.

He was United Presbyterian in faith, and was a member of the Buffalo United Presbyterian Church which was located on the Rayburn farm. "A man of excellent judgement and conservative views, yet positive and earnest in convictions, he was extremely popular with his neighbors."

After the death of his first wife JANE GALBRAITH he married MARGARET BOYD born ca 1820, she was the daughter of Robert Boyd and wife Jane (who was born ca 1769 and was living with James when the 1860 census was taken.)

Children of Jane

- i Hulda Rayburn-
- ii William Rayburn-b ca 1836
- iii Jefferson Rayburn-
- iv Ellen Rayburn-
- v Mary Rayburn-

Children of Margaret

- vi Margaret B Rayburn-
- vii Jane Rayburn-b ca 1944
- viii Boyd Rayburn-b ca 1846
- ix Rob Rayburn-b 1848 apparently died young
- twin 1,42 x Calvin Rayburn-b Oct 25, 1850
- twin xi Cyrus Rayburn-b Oct 25, 1850
- xii Davie Rayburn-b ca 1853 apparently died young

1,19-MATTHEW RAYBURN/ Eleanor Callen/ Patrick Callen

MATTHEW RAYBURN was born (32)May 2, 1808. He followed the Rayburn tradition of farming. (29)He and his family lived in Armstrong Co, Pa. (32)Matthew married MARY MINTEER who was born May 8, 1813, she was the daughter of William and Mary (Nicholson) Minteer of W Franklin Twp. (10)He was a soldier in the Revolutionary War.

The Rayburn's were of the Presbyterian faith, and are buried at the Slate Lick Reformed Presbyterian Cemetery in Armstrong Co, Pa.

Children

- i Jethro Rayburn-b Oct 31, 1833 d Jul 5, 1872
buried Slate Lick Reformed Presby Cemetery
- ii Mary Ellen Rayburn-b Apr 15, 1835 d Aug 28, 1858
buried Slate Lick Reformed Presby Cemetery
- iii James H Rayburn-b 1838 Civil War veteran
m SARAH GARVER
- iv Eliza Y Rayburn-b ca 1841 m THOMAS STEWART
- v Nancy E Rayburn-b ca 1842 m CYRUS WILSON
- vi Margaret J Rayburn-b 1845 d 1912 m WILLIAM REMALEY
- 1,43 vii Sarah Rayburn-b 1848 - d 1939
- viii Matthew Rayburn, Jr-b Dec 1, 1849 d Feb 6, 1888
m HARRIET (UNKNOWN)
- ix Malinda Rayburn-b ca 1850 m AARON LEASURE
- x Olive Rayburn-b ca 1854 m WILLIAM FRANTZ

1,20-JAMES C GALBRAITH/ Mary Callen/ Patrick Callen

(18)"JAMES C GALBRAITH was a stanch Democrat and served at one time as sheriff of Clarion county. His half brother Joseph Galbraith was originally an old-line Whig and later a Republican, uniting with the latter party at the time of its organization. Though their fraternal loyalty and regard never wavered, their conflicting political views led them into many a heated discussion, both in person and by correspondence." (1)(wife possibly ESTER MILLIN?)

James died in Callensburg, nearly 90 years old.

1,21-JAMES F CALLEN/ David/ Patrick Callen

(29)JAMES FLEMING CALLEN was born around 1817 in Pennsylvania the son of David and Elizabeth (Fleming) Callen. James was a farmer by trade. In 1850 he was living in Marshall Co, Illinois where his father also lived. The 1850 census shows his wife as PRISCILLA (unknown) who was born around 1821, but the 1860 census shows his

wife as C Callen. (37A)James died around 1897 or 1899 in Fairfield, Illinois.

Children

- 1,44 i Margaret Callen-b ca 1843 in Pa
- ii David Dewitt Clinton Callen-b 1845
- iii Mary Ann Callen-b Mar 1850 in Ill
- iv Effie Callen-b Apr 1860
- ?? John Murray-b ca 1840?? in Indiana

1,22-WILLIAM CALLEN/ David/ Patrick Callen
(37E)WILLIAM CALLEN was born May 26, 1821 in Westmoreland Co, Pennsylvania, he was the son of David and Elizabeth (Fleming) Callen. (29)He was living in Saratoga Twp, Marshall Co, Ill in 1850 & 1860. (37E)"The family moved to Iowa in 1870." They are shown on the 1880 census in Adams Co, Iowa.

(29)William was a farmer by trade. (37E)"He was a soldier in the Civil War, serving three years with the 86th Illinois Regiment and the 47th."

(29)He married "KATE" (37E)CATHERINE GRIEF on December 24, 1824. Census records show that she was born in Pennsylvania but family records show she was born in Hessen, Germany. "Mother's 2 sisters [were] Christina Betts, Mary Hall; brother John Grief."

Catherine died in Prescot, Iowa on November 30, 1891; William died May 8, 1901 in the Soldier's Home in Grand Island Nebraska.

Children

- 1,45 i Elliot Newton Callen-b Feb 22, 1849
- ii Cynthia June Callen-b Dec 1, 1850
 - m DARIUS P KERNS Oct 1871 d May 8 1917 Corning Ia
- 1,46 iii Mary Luceta Callen-b Dec 3, 1852
- iv Frank M Callen-b Dec 8, 1854
 - d Jul 31, 1915 Broken Bow, Neb
- iv Charles W Callen-b Sept 29, 1856
 - d Jul 13, 1936 Salem, Oregon
- v Miles D Callen-b May 23, 1859 buried Willowbrook, Ca
- vi Anna B Callen-b Mar 14, 1861 lived Creston, Iowa
- 1,47 vii Emma S Callen-b June 29, 1867

(37E)January 7, 1947

Miss Edith Callen (see descendant 1,101)

"William Callen was born in Pennsylvania

"He enlisted from Peoria, Illinois on August 27, 1862 to serve as a Sergeant in Company C, 86th Illinois Regiment, Infantry. He was discharged on June 6, 1865 at Washington, D.C.

"He was admitted to this home from Omaha, Nebraska, January 11, 1894 and remained until his death May 8, 1901, age 77 years. His remains are buried in the cemetery here at the home, Row 4, Grave 28.

"I'm sorry I can give you no military record. Yours very truly,
NEBRASKA SOLDIERS' & SAILORS' HOME."

1,23-JOSEPH CALLEN/ David/ Patrick Callen

(37A)JOSEPH CALLEN was born August 27, 1829, the son of David and Elizabeth (Fleming) Callen. The name of his wife is not known but she was born around 1836. His daughter writes "Mother lives with us. Her next birthday she'll be 87 and aside from having to walk with crutches, the result of a fall when she was 80, she is well and healthy." Joseph died August 19, 1894.

Children

(not necessarily by order of birth - may be partial list)

i Lettie Callen-b

twin ii Dell Callen- "died when a young lady"

twin iii Ethna "Belle" Callen- m CAREY V THORNE

1,24-ARTHUR F CALLEN/ David/ Patrick Callen

(37A)ARTHUR FLEMING CALLEN was the son of David and Elizabeth (Fleming) Callen. He was born May 14, 1832 in Armstrong Co, Pa. (29)In 1850 he was 18 years old and living with his parents in Marshall Co, Ill.

Arthur was a farmer by trade. (37A)On July 2, 1855 he married MARY REBECCA HOLLER who was born April 21, 1838 in Indiana Co, Pa. (29)In 1860 they were living in LaPrairy Twp, Marshall Co, Ill. It's interesting to note that living next door to them was George Weir who was born in Pennsylvania (see 1,12 David & Mary (Weir) Callen).

(37B)Claude C Callen says "Grandfather...was very fond of singing, and a song which he was especially fond of and sang quite often, while going about his work or chores was, "I must tell Jesus all of my troubles, I cannot bear my burden alone". Grandfather was quite religious and very sincere in it. When about 12 or 13 years of age, I was a member of his Sunday School class at the Benton Methodist Church, and I found him to be very interesting as a teacher, in fact, the best Sunday School teacher in my experience.

"He always wore a full beard as far back as I can remember him. He was quite an active man, even up to his later years. At past 60 he would often break into a slow run instead of a walk when he was in a hurry."

(29)In 1870 Arthur was living in Saratoga Twp, Marshall Co. By 1880 they were living in Adams Co, Iowa. (37B)Arthur died April 12, 1906. "He died as a result of some form of stomach trouble, as it was diagnosed in those days." Mary died May 11, 1917 both died in Benton, Iowa.

- Children - (all born in Illinois)
- 1,48 i Alva Barrett Callen-b Oct 15, 1856
 ii James Hardin Callen-b May 4, 1857 d May 2, 1860
 iii Samuel Edward Callen-b Mar 3, 1861 d Feb 17, 1949 Neb
 iv Harvey Edwin Callen-b Mar 17, 1863 d Jan 27, 1926 Ka
 1,49 v David Dewitt Callen-b Dec 3, 1865
 vi Lititia Agnes Callen-b Mar 22, 1870 d Feb 8, 1944 Ia
 m WILLIAM "EDWARD" SMITH of Oelwein, Iowa
 vii Charles Callen-b Oct 23, 1872 d Oct 5, 1899 Ia
 viii Lelia Lois Callen-b June 1, 1877
 m ISAAC F THARP of Des Moines Iowa
 ix child died in infancy

obituary of ARTHUR FLEMING CALLEN
 (Mt Ayr "Twice-A-Week-News")

Was born in Armstrong Co., Pa. May 14, 1832. Moved to Marshall County, Illinois, where he was united July 2, 1855 to Mary Rebecca Holler. They spent 51 years of a happy union together.

To them were borne nine children; two died in infancy. Charlie Callen lived to be 26 years old. Three of the sons and two daughters were at home in his last illness and were at the bedside when he breathed his last. Mr. Callen moved to Benton from Clio, Iowa in 1892, where he lived until the day of his death, April 12, 1906.

He joined the Methodist church when he was about 20 years old, and retained his membership until he came to Benton. There being no Methodist church at this place at this time, he put in his letter with the United Brethern Church. He gave 53 years of his life to the service of the Lord, whom he loved and worshipped. We shall miss him very much in his Sunday School work.

He was a kind and affectionate husband and a loving and consecrated father, and we feel that we have lost a good Christian father when we say "Good Bye" to "Father Callen".

The funeral services were conducted by the Rev. Hiram Tharp. We laid his body to rest in the Benton Cemetery, to await the sounding of the trumpet in the Resurrection Morn.

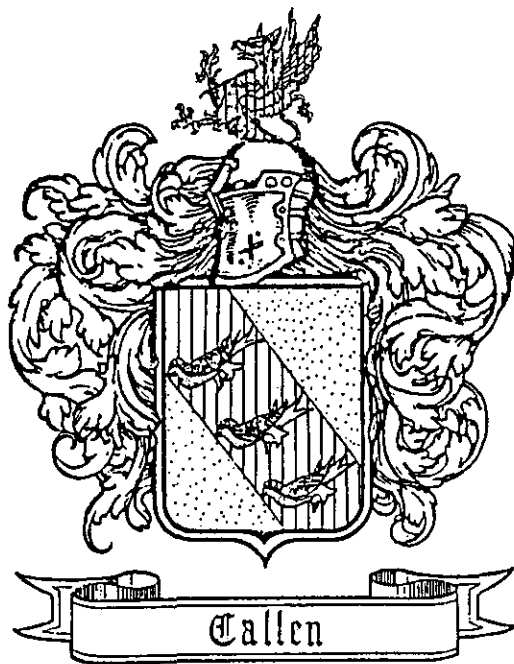

LINE OF PATRICK CALLEN - 4TH GENERATION

1,25-JACKSON CALLEN/ Thomas/ Hugh Sr/ Patrick Callen

(29)JACKSON CALLEN was born around 1819, probably in Armstrong Co, the son of Thomas and Mary Ann (Jackson) Callen. (11)He married SARAH JANE (unknown) sometime after 1850. Jackson died in 1867, his children chose as a legal guardian, Jacob Duncan.

Children

- i Thomas Callen-over 14 yrs of age in 1867
- ii Mary Ann Callen-under 14 years of age in 1867

1,26-HUGH CALLEN/ Thomas/ Hugh Sr/ Patrick Callen

(21)HUGH CALLEN was born May 8, 1822, the son of Thomas and Mary Ann (Jackson) Callen. (31)He married MARY A. GOODENOUGH who was born June 27, 1823 in Binghamton, N.Y.

He may be the Hugh Callen who served as (30)"2nd Lieutenant of the 'Washington Rangers' attached to the 6th Battalion volunteer within regiment of the militia of...Pa in the second Brigade of the 15th Division composed of the Militia of the Counties of Allegheny, Armstrong, Indiana, and Jefferson"...until the 3rd day of August 1842.

Hugh died December 22, 1891. On the 1900 census for Sigel, Mary is shown as "living alone". Mary died December 29, 1901. Both are buried in Mt. Tabor Cemetery, Jefferson Co, Pa.

Children

- 1,50 i Alpheus Callen-b July 14, 1849
- 1,51 ii Thomas J Callen-b 1851
- 1,52 iii William W Callen-b Apr 2, 1855
- 1,53 iv Henry H Callen-b Sept 11, 1857
- 1,54 v Joseph Albert Callen- b Feb 25, 1860
- vi Melida Ann "Lida" Callen-b Jul 16 1862
 - m GEORGE BERTRAND McCLELLAND SHAFFER
- 1,55 vii Clarissa "Blanch" Callen-b ca 1866-70

obituary of MARY A CALLEN

(Jeffersonian Democrat - Jan 2, 1902, Jan 9, 1902)

We learn that Mrs. Mary A Callen, widow of Hugh Callen, deceased, died last Sunday, Dec. 29th, 1901, at the home of her daughter, Mrs. Blanche Stahlman, in Barnett Township, Jefferson County, aged 78 years, 6 months, and 2 days. Five sons and two daughters survive her. Mrs. Callen had lived in Eldred Township about 45 years. Her funeral was on Tuesday, interment being in Mt Tabor Cemetery. Her daughter, Mrs. Stahlman, returns her sincere thanks to the neighbors and friends who showed so much kindness before and after her mother's death.

Mrs. Hugh Callen, one of the oldest ladies of Eldred Township, died at the home of her daughter Mrs. Armstrong Stahlman, Dec. 29, and was laid to rest in the Mt Tabor Cemetery, Tuesday Dec. 31, 1901.

The deceased had been a sufferer for many years. She leaves seven children to mourn her loss, five boys and two girls.

Joseph Callen returned to his home in West Virginia after attending his mother's funeral. He was accompanied by his niece, Mabel.

1,27-JOHN CALLEN/ Thomas/ Hugh Sr/ Patrick Callen

(29)JOHN CALLEN was born around 1830 the son of Thomas and Mary Ann (Jackson) Callen. In 1860 he married MARY ANN REDIC (Redick), at which time they were living in Kellersburg, Armstrong Co, Pa, in the home of his mother. (6)Mary Ann was the daughter of William and Jane (Jackson) Redic, and was born ca 1831.

(29)By 1870 they had moved to Parker Twp, Butler Co, Pa. Mary Ann died sometime around 1878, John died sometime around 1888-91. A niece believes they are buried in the Kelly Cemetery in Parker Twp, but no headstones, wills, or obituaries have been found to verify this.

Children

- 1,56 i Sarepta "Jennie" Callen-b ca 1862
- 1,57 ii William T Callen-b ca 1864
- 1,58 iii James A Callen-b Nov 1, 1868
- 1,59 iv "Si" Josiah P Callen-b July 3, 1868?/1871?
- 1,60 v Charles Herman Callen-b Nov 6, 1875



WILLIAM, JOSIAH, CHARLES, JAMES
SAREPTA?

1,28-JOSIAH J CALLEN/ Thomas/ Hugh Sr/ Patrick Callen
JOSIAH J CALLEN was born (6)March 1, 1840 in Madison Twp,
Armstrong Co, Pa. He was only 6 or 7 years of age when his father
died.

He served in the Civil War, (9)in the 62nd Regiment Company D under
the command of Maj A.W. Lowry, and Capt Wm C Beck. He was promoted
to Corporal on July 1, 1862. "The Sixty-second proceeded to
Washington, and thence, September 11, into Virginia. Subsequently
it bore itself well in the actions at Gaines Mill, the second battle
of Bull Run, Fredericksburg, Antietam, Chancellorsville,
Gettysburg, the Wilderness, Spottsylvania, Bethesda Church, and
also in minor engagements." (21)He was wounded in both legs and
received a pension amounting to \$6.00 a month for his services.

(29-12)Josiah married MARY ELLEN COWAN who was born June 22, 1847,
in Armstrong Co, Pa. Josiah died January 29, 1916, cause of death
is listed as "infirmities of age". Mary Ellen died January 5, 1904;
both are buried in Ford City, Pa, in the Manor Twp Church Cemetery.

Children

twin 1,61 i John H Callen-b Jan 16, 1866
twin 1,62 ii James E Callen-b Jan 16, 1866
1,63 iii David O Callen-b Dec 31, 1867
1,64 iv Charles T Callen-b Apr 5, 1871
 v Hurlbert Callen-b Sep 8, 1877 d Oct 20, 1877
 buried in Kellersburg, Armstrong Co, Pa

Will of JOSIAH J CALLEN (filed Armstrong Co, Penna)

I, Josiah J Callen of the Borough of Ford City in The County of
Armstrong and State of Pennsylvania "Yeoman" being of Sound mind,
Memory, and understanding do make this _____ Publish: as my last
will and Testament, hereby Revoking and making Void all former wills
by me at any time hereto for made.

And first, I direct that my body be decently interred in the Manor
Church Cemetery in Manor Township in Armstg Co, Pa according to the
Rites and Ceremonies of the M.E. Church and that my funeral be
Conducted in a maner corresponding with my estate and Situation in
life:

As to such estate as it hath Pleasd God to intrust me with. I
dispose of the same as follows: Viz

That is to say I _____ that all my Just debts funeral Expenses and
Charges of Probating this my last will be in the first Place fully
Paid And Satisfied and after Payment thereof and Every Part thereof.

Item 1-I give and Bequeath to my Sons James E., David O, and the
three children of my son Charles now decd, Ida Bell, Hurlbert and
Charles the 2 houses and Lots at Graff(?) in Manor Township, Armsg

County, Pa. James E & David O to recv Each the one third and the Three Heirs to Charles Decd Viz Ida Bell, Hurlbert and Charles the other one third.

Item 2-I give and bequeath to my Daughter-in-law Mrs. Lottie Callen Five Dollars in Cash.

Item 3-The Remainder of my Effects Current___ of Money in hand and Personal Property what Ever at My ___ after Pay my Just debts & I bequeath to my two sons James E & David O, Share and Share alike -

And I do hereby constitute and appoint my Son David O Callen Sole Executor of this my last will and testament. In witness whereof I Josiah J Callen the Testator have to this my will written in the Two Sides of an half sheet of Paper Set my hand and Seal this 2 day of Janny AD One thousand nine Hundred and five.

Witnesses: Josiah J Callen seal
George H Burns; J.F. McNutt

I Josiah J Callen the within named testator do hereby make and Publish this Codisil to my last will and Testament having date 2 day of Jany AD 1905 in manor following to Wit - Item That there is no bills? to be Brought in as Settled by E_____ of the Heirs named to my will - In witness _____ I have hereunto Set my hand and Seal this Six day of Janny AD 1905. Josiah J Callen seal

1,29-HUGH C WILSON/ Sarah Callen/ Hugh Sr/ Patrick Callen
HUGH CALLEN WILSON was born in 1830, probably in Callensburg, Pa. He was the son of Samuel and Sarah (Callen) Wilson. His headstone shows he served in Company E, 10 PR B63 USA, this would probably be the Civil War.

He married ELIZABETH E (unknown) - there is a headstone and a footstone for her, one says she died in 1920 the other shows she died on Jan 9, 1885 aged 52 years, the 1885 death date agrees most with the census records. Hugh died in 1913, they are both buried in the Callensburg cemetery.

Children

- i Jennie S Wilson-b ca 1858
- ii E Bertha Wilson-b ca 1867
- iii Alice B Wilson-b ca 1870
- iv Carrio A Wilson-b ca 1872
- v Emma A Wilson-b ca 1874

1,30-ELIZA REICHART/ Polly Callen/ Hugh Sr/ Patrick Callen
(17)ELIZA REICHART was the daughter of Polly (Callen) and Michael Reichart. She married WILLIAM P LASH.

Child

- i Urbana Callen Lash (male)-

1,31-THOMAS J CALLEN/ James/ Hugh Sr/ Patrick Callen

(36A)THOMAS JEFFERSON CALLEN was born February 2, 1842, the son of James and Eliza W (Laughlin) Callen, and was probably raised in Callensburg. (10)"Until he had attained his majority, Thomas J Callen remained under the parental roof, and then worked for one year in a sawmill.

"In February 1864, he enlisted in Co A, 103d P.V.I., the company being first commanded by Capt R Laughlin and later by Capt A. A. Alexander. (15)[He served as a Rank Corporal, and mustered out June 25, 1865.] On receiving his discharge our subject returned home, and a short time afterward went to Monroe township, Clarion County, where he rented a farm for four years. He then purchased his present place of ninety-six acres in Piney township, which he has placed under excellent cultivation and improved with good and substantial buildings.

"On September 19, 1869, in Limestone Township, Clarion County, Mr Callen was married, by Rev Elder, to Miss CLARISSA L SMITH" who was born in 1840. "Her father, Lucius Smith, was a native of Connecticut, but spent his last years in Clarion county.

"In December, 1889, our subject was again married, this time to Miss ROSE E MOONEY, [who was born (29)September 1850] ceremony being performed by Rev McCurdy. Her father, John Mooney, a retired farmer residing in Churchville Penn was born in Centre county Jan 30, 1827...

"Our subject belongs to the Murphy Grange of Clarion county and to the Grand Army Post of Sligo; and in religious belief both he and his wife are prominent members of the Presbyterian Church. They are widely and favorably known throughout the community and their circle of friends is only limited by their circle of acquaintances."

(29)In 1900 they were living in Piney Twp, Clarion Co. Also living with them was Edward Mooney, brother-in-law (the census incorrectly spelled his name Mohney.)

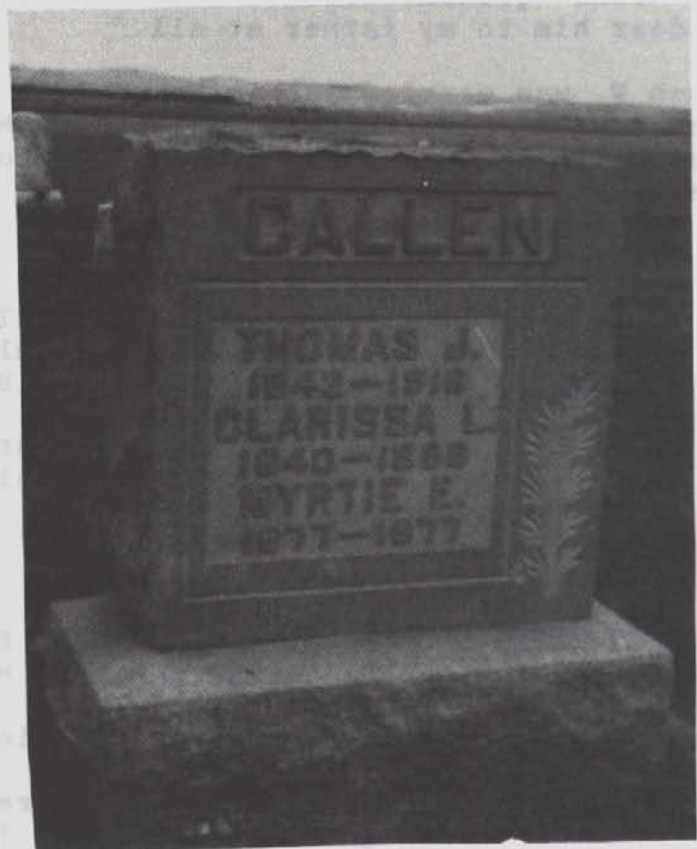

MT ZION CEMETERY

Thomas died in 1916, Clarissa died May 3, 1888, both are buried in Mt. Zion Cemetery, Piny Twp, Armstrong Co, Pa.

Children

- 1,65 i Mary Eliza Jane Callen-b Apr 11, 1871
- 1,66 ii Hugh Smith Callen-b Sep 20, 1872
- 1,67 iii Curtis Edward Callen-b Feb 23, 1874
- iv Myrtle Ellie Callen-b Jan 25, 1877 d Mar 1, 1877
- 1,68 v Verda Louemma Callen-b Feb 18, 1878
- 1,69 vi James Harry Callen-b Feb 15, 1880
- 1,70 vii William Ellsmore Callen-b Nov 22, 1883
- 1,71 viii Arminta Arzula Callen-b Oct 14, 1886

1,32-HUGH W CALLEN/ Samuel/ Hugh Sr/ Patrick Callen

(29)HUGH WORTHINGTON CALLEN was born around 1843, the son of Samuel and Elizabeth (unknown) Callen. (34A)"There is a picture of him and grandmother... He was a handsome man...I take it from hearing my father talk--that granddad liked the girls,...he was rather tyrannical when my dad was young and dad felt that he was never overly kind or completely deserving of my grandmother Callen whom my father idolized and spoke of as somewhat of a saint...Grandfather Callen married a woman Mary Leila...the story goes [Granddad] played around with the hired girl (Mary Leila) while my real grandmother was critically ill and dying--which didn't endear him to my father at all."

Hugh W. was married 1st in March 1870 to MARY of Olean, N.Y. (one descendant says she was MARY STRATTON - another descendant says she was MARY CELESTE FREEMAN), and 2nd to MARY LEILA (unknown). It is believed he died around 1907-10.

Children of 1st wife Mary

- i Frank Callen-b
- ii Birdie Callen-b ca 1872
- 1,72 iii Elmo Hugh Callen-b July 2, 1873
- 1,73 iv Harry Earl Callen-b 1878
- v daughter-b

Children of Mary Leila

- vi Joseph Worthington Callen-b May 5, 1905 in Mayport, Clarion Co, Pa
- vii daughter-b

1,33-SARAH L CALLEN/ Hugh Jr/ Hugh Sr/ Patrick Callen

(33F)SARAH LOVENIA CALLEN was born May 9, 1841, the daughter of Hugh and Jane E (Elliot) Callen, Jr. (17)She married ROSS S NICKOLS who was born January 4, 1847, Ross died November 30, 1923.

Children

- i Hugh C Nickols-b Aug 1, 1875
- 1,74 ii Jane Eliza "Jennie" Nickols-b April 13, 1878

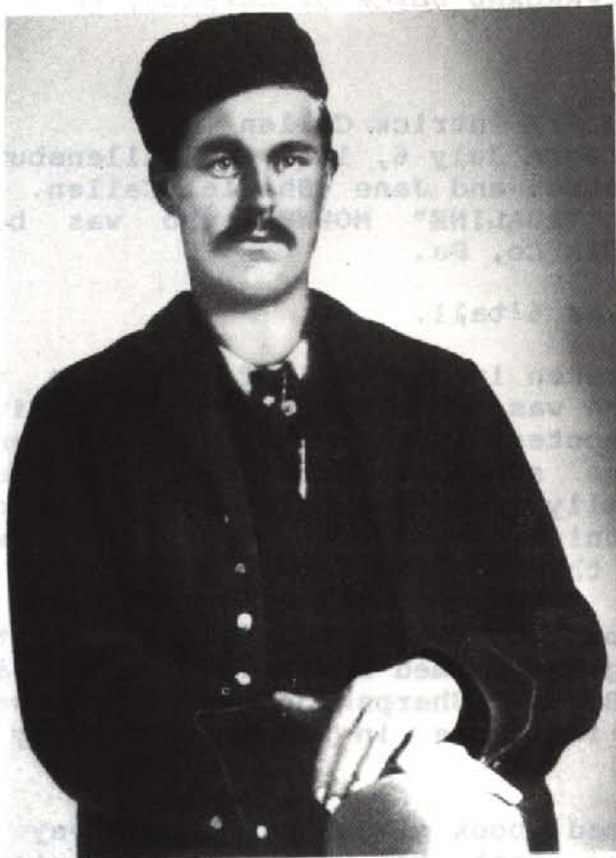

JOHN H CALLEN



ADALINE (MOHNEY) CALLEN



WILLIAM, GEORGE, MELVIN, LEON, PAGE

1,34-MARY CALLEN/ Watson/ Hugh Sr/ Patrick Callen
(29)MARY CALLEN was born around 1840 in Callensburg, Clarion Co, Pa. (35A-35B)She married ANDREW McFARLAND SLACK of Corsica, Pa. Mary died after 1908.

1,35-JOHN H CALLEN/ Watson/ Hugh Sr/ Patrick Callen
(35A-35b)JOHN HARVEY CALLEN was born July 6, 1842 in Callensburg, Clarion Co, Pa; the son of Watson and Jane (Shadle) Callen. On September 4, 1864 he married HAZEL "ADALINE" MOHNEY who was born September 29, 1848, in Keystone, Elk Co, Pa.

John was a lumberman, and stood over 6'tall.

There is a photo of John H (35B)"taken in the fall of 1861 in the uniform he originally wore when he was a new enlistee [in the Civil War] in the United States Sharpshooters - Company C, 2nd Regiment. Later he was uniformed in the standard dark blue coat and accessories of the Union army; family tradition holds that a photo existed of him in the Union uniform that was taken while he was stationed in Washington D.C. with the Army on the Potomac."

(35K)"I have his Cap. It shows U.S.S.S. for United States Sharpshooters. This was a small group formed by a man named Berdan, and is often referred to as The Berdan Sharpshooters. They were credited with having a great influence in saving the day at Gettysburg."

There is a (35B)"small (pocket sized) book given to John Harvey by ...Jane (Shadle) Callen when he went to war. It is signed "Grandmother Callen". The book contains an appropriate Biblical verse for each day of the year. John Harvey carried this little book in his uniform breast pocket through the War. It is blood stained (his blood), but is in beautiful condition."

John died March 30, 1914 at Allen's Mills, Jefferson Co, Pa; Adaline died February 6, 1941 in Cleveland, Cuyahoga Co, Ohio. Both are buried in Wildwood Cemetery, Brockwayville, Jefferson Co, Pa.

Children

- 1,75 i Frederick Alvin Callen-b Apr 16, 1865
- 1,76 ii Anna Jane Callen-b Oct 16, 1866
- 1,77 iii William Thomas Callen-b ca 1870
- iv Mary Dakota Callen-b ca
- v James Watson Callen-b Oct 6, 1873 d Aug 24 1879 His mother wrote in the margin of her almanac "Jimmie died the 24th" and at the bottom of the same page is written "Baby born the 29th"
- 1,78 vi George Walter Callen-b Mar 1, 1876
- 1,79 vii Melvin Harvey Callen-b Aug 29, 1879
- 1,80 viii Leon John Callen-b Oct 6, 1883
- 1,81 xi Harold "Page" Callen-b Oct 3, 1893

1,36-ALVIN C CALLEN I/ Watson/ Hugh Sr/ Patrick Callen
(35C)ALVIN CUMMINGS CALLEN 1st was born May 13, 1849 in Clarion Co, Pa. He was the son of Watson and Jane (Shadle) Callen. On December 31, 1870, in Brockwayville, Pa, he married "MAGGIE" SARAH MARGARET BOWDISH, who was born July 6, 1851. She was the daughter of Philo and Cornelia (Brunson) Bowdish.

(35I)"My Grandfather was a Civil War Veteran, signed up for enlistment at the age of 15."

(35C)Maggie died in 1893 and is buried in Wildwood Cemetery, Brockwayville, Jefferson Co, Pa. Alvin died on May 17, 1929 while on a visit to an army friend in Erie, Pa, and is buried in Erie. His death certificate, sadly, shows his parents as "not known".

Children

- i Carrie Armino Callen-b Sept 29, 1871 d 1923
m WILLIAM KERRY
- ii Jannette "Nettie" Elvira Callen-b Apr 6, 1873
m 1st JOHN CRAMER m 2nd Mr. HASLEY
- iii Lucy Callen-b Mar 1, 1875 died in infancy
- iv Nora May Callen-b May 2, 1876 m JACOB JOHN THUMM
lived in Texas, then in Missouri
- 1,82 v Arthur Alexander Callen-b July 14, 1878
- 1,83 vi Edward Everett Callen-b Oct 26, 1879
- vii Jean Cornelia Callen-b May 10, 1883
m Gen FRANK DORCUS lived in San Antonio, Texas
- 1,84 viii Charles Brunson Callen-b Aug 10, 1886
- 1,85 ix Samuel Watson Callen-b Dec 4, 1887
- 1,86 x Clyde Bartlett Callen-b July 26, 1889
- 1,87 xi Philo LeRoy Callen-b 1891

1,37-SARAH ANN CALLEN/ Watson/ Hugh Sr/ Patrick Callen
(35A-35B)SARAH ANN CALLEN was born April 25, 1852 in Callensburg, Clarion Co, Penna. She was the daughter of Watson and Jane (Shadle) Callen. Anna was (18)"reared and educated in Clarion county."

(18)In Jefferson Co, Pa she married FRANCIS ASBURY BIRD who was born (35M)May 1, 1849 in Shickshinny, Luzerne Co, Pa. He was the son of Elisha and Rebecca (Sharp) Bird. (18)"Being left an orphan at nine years of age, he was reared in the home of his sister..." (John F Bird says "As you will see... Aunt Bertha's information given to the Jefferson Co. "Pioneers and People" was not correct. She sent me down the wrong road." We show this for other researchers of the Bird family line to be careful.)

(18)Francis A Bird was reared and educated in Luzerne Co., Pa in the home of his sister, Mary (Bird) Seabert. As a young man Francis was employed by his brother-in-law, Frank A Seabert, operating canal boats from Wilkes Barre, Pa to Baltimore, Maryland. He then became identified with the various operations of the lumber industry. Later becoming one of the prominent lumber operators in the eastern section of Pennsylvania.

(35L)"Francis migrated to eastern Pennsylvania in the early 1870's. There he married, around 1873, Sarah Ann Callen... Francis and his family were devout members of the Methodist Episcopal Church and was considered one of the better teachers of the Men's Bible Class. Sometime during his early marriage, he became affiliated with the Raine Andrews Lumber Co. and when they moved their operation to a new operation in West Virginia, Francis and his family went with them. This was about the year 1903...

"The Raine Andrews Lumber Co. set a double-band sawmill and later established and built the town of Evenwood, Randolph Co., West Virginia...

(18)"Mr. Bird is independent in politics and both he and his wife are earnest members of the Methodist Episcopal Church."

Sarah died October 28, 1916 in Evenwood, West Virginia, (35L)she is buried in the Taylor Cemetery, Falls Creek, Washington Twp, Jefferson Co "Located on western side of borough." Francis died May 5, 1930 in Evenwood he is buried in an unmarked grave, beside his wife Sarah.

Children

- 1,88 i Bertha J Bird-b Mar 27, 1874
- ii Orin Wakefield Bird-b 1875 d 1890 "killed in a sawmill accident when a youth of sixteen years" buried Taylor Cemetery Jefferson Co.
- 1,89 iii Callen Sterling Bird-b Aug 1878
- 1,90 iv Mary Luella Bird-b Mar 1882
- 1,91 v George Arlington Bird-b Dec 1885
- 1,92 vi Clyde Clifton Bird-b Feb 18, 1889
- 1,93 vii Harry Ray Bird-b Jan 1892

1,38-AMANDA J CALLEN/ Watson/ Hugh Sr/ Patrick Callen

(29)AMANDA JANE CALLEN was born around 1854, the daughter of Watson and Jane (Shadle) Callen. (35A-35B)She married ORIN M RHINES on February 22, 1875. Amanda died on March 8, 1908 at her home in Falls Creek, Jefferson Co, Pa.

Only Child

- i Edwin W. Rhines- died from fall from a moving train

1,39-MATILDA CALLEN/ Watson/ Hugh Sr/ Patrick Callen

(29)MATILDA CALLEN was born around 1856 the daughter of Watson and Jane (Shadle) Callen. (35A-35B)She married GEORGE C RICKER of Russell City, Pa. (35B)They later moved to McKittrick, Colorado - McKittrick is now a ghost town.

1,40-ALICE CALLEN/ Watson/ Hugh Sr/ Patrick Callen
(29)ELIZABETH ALICE CALLEN was born around 1858, the daughter of Watson and Jane (Shadle) Callen. (35A-35B)"Alice" married WAKEFIELD BROCKWAY of Arrow, Pa. They later lived in Washington State.

1,41-LOUISE E CALLEN/ Watson/ Hugh Sr/ Patrick Callen
(29)LOUISE EMMA CALLEN was born around 1861. She married WILL W SCOTT of Hicks Run. (35A-35B)They later lived in Butler, Pa. Louise died after 1908.

1,42-CALVIN RAYBURN/ James/ Eleanor Callen/ Patrick Callen
CALVIN RAYBURN was born October 23, 1850 on the old Rayburn homestead in North Buffalo Twp, Armstrong Co, Pa. He was a twin, his parents were James and Margaret (Boyd) Rayburn.

(10)Calvin attended school at the Slate Lick Academy and entered Princeton University in 1871, graduating in the class of 1875. He taught in the public schools for 3 terms and was principal of Queenstown public school in Armstrong Co one winter.

In June 1877 he began his study of law under the Hon. George A. Jenks of Brooksville, who later became the Ass't Attorney General under President Grover Cleveland's administration.

In June 1879 Calvin was admitted to the bar of Jefferson Co, and in November was admitted to practice in Armstrong Co, opening his office in Kittanning. "He was a lawyer of high standing and enjoyed an extensive legal practise."

On October 19, 1886 he married MARGARET MCFADDEN daughter of Dr James McFadden of Buena Vista, Allegheny Co, Pa

In 1889 he was unanimously nominated by the Democratic party of Armstrong Co for President Judge, and won by a majority of 722 votes. He was one of the youngest judges to serve in Penna. "and his services on the bench were characterized by firmness, fairness and legal acumen."

Like his father, Judge Rayburn was an active member of the Democratic party. He was a delegate to the National Convention in Chicago in 1884 at which Grover Cleveland was first nominated for the presidency, and he was a delegate at the National Convention in St Louis in 1904.

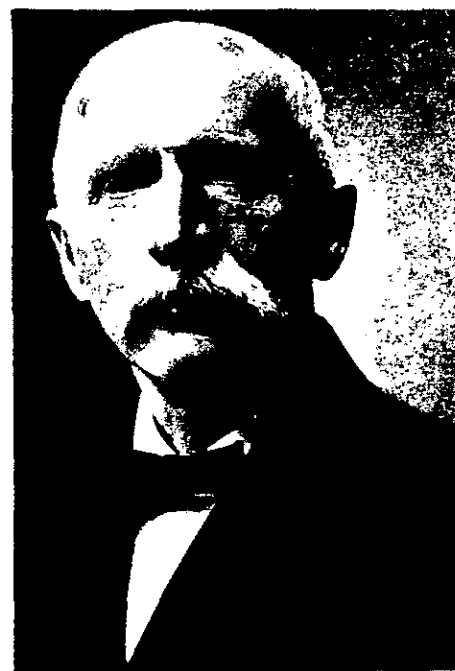

CALVIN RAYBURN

"As a man he is pleasant and agreeable; as a lawyer he is careful and correct, and as a counselor is safe. His analysis of a case is very clear and exact, and he is one who would rather win a cause by clearness of statement and justness of argument than by fervor of appeal."

He was "generally beloved for nobility of character". He continued in legal work until his death on May 16, 1929, he is buried in the Kittanning cemetery, Armstrong Co, Pa.

Children

- 1,94 i James Rayburn-b
 ii Calvin Rayburn Jr-b
 iii Margaret M Rayburn-b

1,43-SARAH RAYBURN/ Matthew/ Eleonor Callen/ Patrick Callen

(32) SARAH RAYBURN was born around 1848 the daughter of Matthew and Mary (Minteer) Rayburn. She married EUGENE A STEELE who was born around 1848, he was the son of Isaac L and Mary Ann (Ralston) Steele. Sarah & Eugene lived in Hoboken, (now Blawnox) in Allegheny Co in 1901 and later lived in Grove City, Pa.

Eugene died in 1916, Sarah died in 1939. "They are buried with the Rayburns and Mintees in the Slate Lick Reformed Presbyterian Churchyard."

Children

(not necessarily by order of birth)

- i Harry Steele-b Aug 28, 1871 d May 11, 1957
 m MARY MAY
ii Clifford Steele-b 1878 d Oct 12, 1880
1,95 iii Ida Steele-b Feb 25, 1882
 iv Claude Steele-b 1885 d Aug 11, 1890 of diphteria
 v John Steele-b
 vi Jesse Steele-b m ORLO W GEARY
 vii Eugene Paul Steele-b m NANCY VAN ORSDALE
 viii Lenore Steele-b m Mr. CRAWFORD
 ix Clyde Steele-b

(Note - "one of the boys was born July 28, 1890")

On November 18, 1889 the Freeport Gazette reported that Eugene was hurt when he fell 20 feet from the hay mow to the barn floor. He was seriously hurt, but had no broken bones.

1,44-DAVID D C CALLEN/ James F/ David/ Patrick Callen

(37F) DAVID DEWITT CLINTON CALLEN was born in 1845 in St. Louis, Missouri, we believe him to be the son of James Fleming Callen. He married LOUISA THERESA BATES who was born in 1847 in Iowa. Louisa died in 1885, David died in 1918.

Children

- i James L Callen-b
ii Maude Callen-b

- iii Effie Callen-b
- iv Mabel Callen-b
- v Herbert "Bert" Ralph Callen-b
- vi Martin T Callen-b
- 1,96 vii Leigh Bates Callen-b Apr 11, 1879

1,45-ELLIOT N CALLEN/ William/ David/ Patrick Callen
 (37E)ELLIOT NEWTON CALLEN was born on February 22, 1849 in Lacon, Marshall Co, Illinois, he was the son of William and Catherine (Grief) Callen. Elliot was a carpenter by trade. On July 1, 1874 he married NANCY ELLEN NUTTER in Corning Iowa. Nancy was born on February 4, 1854 in Pella, Iowa, she was a housewife.

Elliot died in St Louis (or Clayton) Mo, on February 29, 1933; Nancy died on October 2, 1943 in Clayton, Mo and is buried in St. Peters Cemetery, St. Louis, Mo.

Children

- 1,97 i Iona Barbara Callen-b Jun 9, 1875
- 1,98 ii Edna Daisy Callen-b May 11, 1878
- iii Lucien Seth Callen-b Mar 28, 1880 in Taylor Co, Iowa
- 1,99 iv George Callen-b Jan 14, 1882
- 1,100 v Arthur Roscoe Callen-b Dec 4, 1886?
- 1,101 vi Edith Callen-b July 26, 1887?
- 1,102 vii Evelyn Callen-b Dec 24, 1889
- 1,103 viii Faye Callen-b Jan 15, 1891

1,46-MARY L CALLEN/ William/ David/ Patrick Callen
 (37E)MARY LUCETA CALLEN was born December 3, 1852 in Sparland, Ill. She was the daughter of William and Catherine (Grief) Callen. She married ELMER BELDING in June 1875, Elmer was born December 30, 1842. Mary died April 1936 in Corning, Iowa.

Children

- 1,104 i Ida A Belding-b Jul 24, 1876
- 1,105 ii Augusta A Belding-b Sept 14, 1880
- 1,106 iii Nelle Belding-b May 2, 1882
- 1,107 iv Therou Elmer Belding-b Jul 11, 1883
- 1,108 v Oscar Milton Belding-b Sept 28, 1885
- 1,109 vi Ralph Walter Belding-b Apr 10, 1893 in Nebraska

1,47-EMMA CALLEN/ William/ David/ Patrick Callen
 (37E)EMMA SARAH CALLEN (or Sarah Emma) was born June 29, 1867. A letter written by Emma January 27, 1947 states she "was married to JOSEPH EDGEELL in November 1908 Los Angeles divorced 1912. Married WILLIAM ["ALLEN"] CARD November 22, 1922 Los Angeles."

"Gardena, Calif Jan 27, 1947
 Dear Edith & nephews & nieces (see descendent 1,95)

I got your letter of Jan 10 and will try to write a few lines. I am still keeping on here with 1 room rented to a good working man. I get a man to do a little work in the yard sometimes but do not

expect to keep it up as Allen did but will try to raise some flowers and some garden like lettuce and onions and the like. We have had more frost this winter than for some time and lasted longer, but think it is over now & it makes me want to get started raising something...

I have a telephone now the no is Menlo 4-4565 was a long time getting it...

Good bye with love from Emma Card. write sometimes."

1,48-ALVA B CALLEN/ Arthur F/ David/ Patrick Callen
obituary of ALVA B CALLEN
(Murdo Coyote, - Oct 3, 1919)

ALVA BARRETT CALLEN, the eldest son of Arthur Fleming Callen and Mary Rebecca Holler, was born in Sparland, Ill. on Oct. 15, 1856 and departed this life after a brief illness at the home of his daughter, Mrs. A.J. Johnson on Sept. 24, 1919, age 62 years, 11 months, and 9 days.

The deceased spent his early life in the state of Illinois. When eighteen years old, he with his parents moved to a farm near Clio, Iowa (Wayne Co.). About four years later he was united in the holy bonds of wedlock to Miss JENNIE CLARK. Shortly after their marriage they moved to Humeston, Iowa, where their three children, Claude C., Josie A. and Hattie Belle, were born. Later, Mr. Callen and his father with their families moved to Ringgold Co., Iowa and established what is now known as the present site of Benton. He lived there until the year 1904 when he decided to come West to the new country which was then being opened up west of the Missouri River, and to what is now Jones County. He took up his residence near the present townsite of Murdo, and was one of the oldest and best known residents of that town.

(The following part by Claude C. Callen) -- It was in his home life, surrounded by his wife and family that he spent his happiest and best moments. He was ever a kind and sympathetic and loving husband, father son and brother. He was always ready to make any sacrifice for the family's welfare and comfort; he won their confidence, love and respect. He accumulated no great earthly gifts -- a life patiently and honestly and honorably lived.

He won the respect and esteem of all who knew him. Mr. Callen united with the Methodist Church of Murdo, So. Dakota, March 10, 1912 under the ministry of the Rev. C.B. Harrold, and has since been a devoted and faithful member. He will be greatly missed in the community where he has been so well known. His voice [may] be silent, but the memory of his life, like the fragrance of sweet flowers - the work he has so faithfully done, will live on and keep him fresh in our hearts and minds.

He leaves behind to mourn their loss, two sons... and one daughter,
...

In the last year and a half, since the death of his devoted wife on March 3, 1918, he has made his home with his daughter, Mrs. A.J. Johnson (Hattie Belle Callen). He has greatly missed his wife, who was his companion; his helper; and sometimes, it seemed that he was a bit lonely, and wished to go and be with her. He lived a good life and always interested in the welfare of his own and others, standing out for the higher and better things of the community's life. He was a faithful attendant at church and Sunday School and unless sickness or other good reason kept him away, he was always there. He was a good listener to the preaching of the Word and it always seemed to do him good. He was not much given to criticism, but always manifested the spirit of brotherly love and kindness. Many knew and loved him; his life was not lived in vain. God said: "Your work on earth is done, come up higher." He was patient and bore his suffering at the last, nobly. Everything that mortal hands could do was done to save his life.

The tiny brittle thread that held him soon snapped as under and we believe his soul mounted upon snowy white wings to be with God; we trust that our great loss will be his gain -- he lives on and on, his Heavenly Home will never end. He was ready and we believe, prepared to go; he had made his decision to follow Christ, and Christ, the One, the only One who is able to save, has saved him today and he is in safe-keeping until that great day when we shall all meet again in glad and happy reunion and clasp each other's hands. (End of Claude C. Callen's part)

What is more beautiful than the noble end of a useful life? It is like a beautiful sunrise when the day is young; like rosy-tinted sunset when the day is old. His life was well spent.

Grow old along with me,
The best is yet to be,
The last of life for which
The first was made.

The one thing I find, we two are so joined he can't go to Heaven
and leave me behind.

Children

- 1,110 i Claude C Callen-b Apr 1, 1880
- 1,111 ii Josie Alva Callen-b Oct 3, 1882
- 1,112 iii Hattie Belle Callen-b July 4, 1884

1,49-DAVID D CALLEN/ Arthur F/ David/ Patrick Callen
(37A-37D)DAVID DEWITT CALLEN was born December 3, 1865 in Sparland Ill. He was the son of Arthur F and Mary Rebecca (Holler) Callen. On January 24, 1886 in Avoca, Cass Co, Nebraska he married JESSIE BENTON BROOKS. Jessie was born July 17, 1865 in Corydon, Wayne Co, Iowa. David was a farmer and school janitor. Jessie died June 29, 1927 in Isabel, Kansas(or Benton, Iowa?); David died September 12, 1934 in Hutchison, Kansas.

Children

- 1,113 i Edward Ellsworth Callen-b Feb 20, 1891
- 1,114 ii Otto Orel Callen-b Aug 31, 1893
- 1,115 iii Cleo Paul Callen-b Sept 12, 1896
- 1,116 iv Harold Verne Callen-b Jan 28, 1899
- 1,117 v Arthur Fleming Callen-b Jul 16, 1907

obituary of DAVID D CALLEN
(Isabel, Kansas Paper)

David Dewitt Callen was born at Sparland, Ill. on the third day of December, 1865. At the age of nine, he moved with his parents to Wayne Co, Iowa (near Clio) and later moved to Avoca, Nebraska. While living at Avoca, Nebr, he became acquainted with Miss Jessie Brooks, whom he married on Jan. 19, 1886.

In 1905, Mr. Callen with his family moved to Kansas and took up their residence near Isabel. This has been called home since that time, although during the past few months, Mr. Callen has spent part of his time in Hutchinson, at the home of his son. It was during one of these visits in Hutchinson, that his call came and he entered into his rest on the 12th day of September, 1934.

Mr. Callen was the father of five sons, the oldest having preceded him in death. Mrs. Callen died in 1927 and was buried from the Isabele M.E. Church, and rests near the place where we will place all that remains of her mortal husband.

Those who survive Mr. Callen are four sons... There are also ten grandchildren, one brother and two sisters.

"Uncle Dave" as he was known to everyone in the community was very much a favorite with the young folk. For a number of years he was custodian of the school building and made many friends among the children and the teachers. He was a member of the Methodist Episcopal Church and the I.O.O.F. Lodge of Isabel, Ks.

Uncle Dave had been ill for some time and his death did not come as a surprise to him. He had made all preparations for the inevitable event. He had selected his hymns, those who were to officiate, and those who were to bear his remains to the silent city on the hillside.

We mourn his loss, but we know there has been many a happy reunion and out in that Great Beyond life goes on and on in a land that shall know no night, and where there shall be no more death.

Funeral services were held at the M.E. Church, Friday afternoon with the Rev. J.W. Millsap, officiating. Internment was at the Isabel Cemetery.

The Larrabee Mortuary was in charge.

LINE OF PATRICK CALLEN - 5TH GENERATION

1,50-ALPHEUS CALLEN/ Hugh/ Thomas/ Hugh Sr/ Patrick Callen
(21-20)ALPHEUS CALLEN was born July 14, 1849 in Sigel, Jefferson Co, Pa, the son of Hugh and Mary (Goodenough) Callen. He married 1st "MAGGIE" MARGARET L AHARRAH who was born (29)July 1854 (1)the daughter of William and Catherine (Elrod) Aharrah. Maggie died in 1913.

Alpheus then married (21)ELLA AHARRAH WOLFORD-CALLEN. (33M)Ella was born August 1, 1865. She was a younger sister to Maggie. "We always addressed her as Aunt Ella and she was also my step great-grandmother. We lived across the street from her until 1942."

Alpheus died March 4, 1930, and Ella died January 17, 1953. All three are buried in the Mt Tabor Cemetery, Jefferson Co, Pa.

Children

- i Charles T Callen-b Sept 24, 1875 d-Mar 26, 1876
- 1,118 ii Perle Callen(male)-b Nov 2, 1877
- iii Hattie M Callen-b Mar 1880 m Mr. HARRIGER
lived in Arkasas City

1,51-THOMAS J CALLEN/ Hugh/ Thomas/ Hugh Sr/ Patrick Callen
(21-20)THOMAS J CALLEN was born (29)October 1851 in Jefferson Co, Pa the son of Hugh and Mary A (Goodenough - his death certificate says Goodrich) Callen. He married (20)AMYTUS PHIELPS who was born (29)February 1851(57?). In 1900 they were living in Cherry Grove Twp, Warren Co, Pa.

Thomas died July 11, 1931, Amytus died in 1922, both are buried in Mt Tabor Cemetery in Jefferson Co, Pa.

Children

- i William Wade Callen-b June 6, 1877 d June 29, 1896
19 years old, single, died from "Dropsey of heat"
- ii Mabel A Callen-b Aug 1879 m Mr. PETREE
- iii Mary Callen-b Aug 1881 m Mr. STILES
- iv Grace Callen-b Dec 1888 d 1969
m JACOB CLAUD TIBBENS-b 1844 d 1942
- v Mark N Callen-b Apr 17, 1891 died Dec 13, 1892
age 1 yr, 7 mo, 6 days died of scarlet fever
- vi Elsie Ransell Callen-b 1895 d 1964
m (WALTER J?) FISCUS-b 1897 d 1937
Pvt 1st Class Co M (WWI)

1,52-WILLIAM W CALLEN/ Hugh/ Thomas/ Hugh Sr/ Patrick Callen
WILLIAM W CALLEN was born (6)on April 2, 1855 in Jefferson Co. Pa, the son of Hugh and Mary (Goodenough) Callen. He (20)was a resident of Falls Creek, Jefferson Co, Pa.

William married (21)ROSA DEE WALLACE who was born (29)May 1860. By occupation he was a merchant. (6)William died from pneumonia on March 5, 1937; Rosa died in 1954. Both are buried at Mt Tabor

Cemetery, in Sigel, Jefferson Co, Pa

Children

- i Debbie E Callen-b Apr 1882
- ii Leila V Callen-b Jun 1885
- iii Chester G Callen-b May 1889
- iv Irma M Callen-b May 1891

1,53-HENRY H CALLEN/ Hugh/ Thomas/ Hugh Sr/ Patrick Callen
HENRY H CALLEN was born on (6)September 11, 1857. He was (20)the son of Hugh and Mary (Goodenough) Callen. He married MARY M GRUVER who was born in June 1865. By occupation he was a farmer.

(21)Henry died of apoplexy and senility on November 15, 1942, Mary died February 24, 1932. Both are buried in Mt Tabor Cemetery, Jefferson Co, Pa.

Children

- i Edna B Callen-b Apr 1884 m Mr. McNEIL
- ii Milton Earl Callen-b Apr 1887
- iii Ralph Lauren Callen-b Sept 14, 1888 d Feb 25, 1905
- 1,119 iv Rolland Charles Callen-b Feb 1891

1,54-JOSEPH A CALLEN/ Hugh/ Thomas/ Hugh Sr/ Patrick Callen
JOSEPH ALBERT CALLEN was born (31)February 25, 1860, the son of (20)Hugh and Mary (Goodenough) Callen. (31)He married "LIZZIE" MARTHA ELIZABETH LAMB on April 2, 1892 in Jefferson Co, Pa. They lived in West Virginia in 1902. There is a note of a Joseph Callen who was a pilot on the Clarion River - it isn't known at this time if it was this Joseph.

Children

- twin i infant-b July 21, 1893
- twin ii Fred Marvin Callen-b July 21, 1893
- iii infant-b Oct 9, 1895
- iv James Hugh Callen-b March 9, 1900
- v John Dale Callen-b June 29, 1902
- vi Arthur Lynn Callen-b May 13, 1904
- vii Sarah Blanch Callen-b Jan 29, 1907

1,55-BLANCH CALLEN/ Hugh/ Thomas/ Hugh Sr/ Patrick Callen
(20)CLARISSA "BLANCH" CALLEN was born in Jefferson Co, the daughter of Hugh and Mary A (Goodenough) Callen. She was born around 1866-67. (33L)She married GEORGE ARMSTRONG STAHLMAN, who was born in 1857, the son of John Stahlman III and Elizabeth (Armstrong) Stahlman. Armstong died on September 2, 1900 and is buried at Mt Tabor Cemetery, Sigel, Pa.

(33L)After the death of Armstrong, Blanch married CALVIN L ROSS. The application for marriage is dated April 15, 1902. This application states her occupation as cook and Calvin's occupation as woodsman. "Other sources state they had a daughter Ruby born at Zion, near Sigel."

Blanch died two years later, around 1904. She is supposedly buried at Mt Tabor Cemetery, but the grave site has not been established.

Children

- 1,120 i Mary Stahlman-b 1891 d 1918
ii Edward Ray Stahlman-b Sept 6, 1894
iii Lee M Stahlman-b May 2, 1898 d Jan 31, 1986
iv infant daughter Stahlman
v Ruby Ross-

1,56-SAREPTA CALLEN/ John/ Thomas/ Hugh Sr/ Patrick Callen
(33B)"JENNIE" SAREPTA CALLEN was born (29)ca 1862, the daughter of John and Mary Ann (Redic) Callen. (33F)She married MR. LACY.

Children

- 1,121 i Carl Lacy-

1,57-WILLIAM T CALLEN/ John/ Thomas/ Hugh Sr/ Patrick Callen
WILLIAM T CALLEN was (29)born ca 1864, the son of John and Mary Ann (Redic) Callen. (25)In October 1889 he married "FANNY" FRANCES E FORINGER. It appears he moved his family to West Virginia.

Children

- 1,122 i Bulah Callen- m JOHN RUBLE
1,123 ii Burl Arthur Callen-b March 9, 1892
1,124 iii Della Callen-
iv son-deceased in infancy

1,58-JAMES A CALLEN/ John/ Thomas/ Hugh Sr/ Patrick Callen
JAMES ARTHUR CALLEN was born (6)November 1, 1868 in Butler Co, Pa, the son of John and Mary Ann (Redic) Callen. James was about 10 years old when his mother died.

He married 1st in (25)April of 1889 to "BERTHA" ELIZABETH THOMPSON who was born (29)May 1867. (33C)She was the daughter of a Methodist minister Warren Thompson and Almira (Aggas) Thompson. Bertha was orphaned at a very young age. She died around (33E)1907-08, and is buried in potters field in Mt. Vernum Cemetery, Butler Co, Pa.

James worked at the Pendrake Oil Refinery. He liked farming and hunting.



JAMES A and BERTHA? CALLEN

After Bertha's death James married "FANNY" FRANCES RUPP. Fanny was born March 11, 1884 in Boggs Twp, daughter of George and Elizabeth (Cochran) Rupp.

(6) James died May 2, 1947, (33D) he is "buried at Belknap Cemetery on or near Route 66 North of Kittaning" near Templeton, Armstg Co, Pa.

Children of Bertha

- i Mary E Callen- b Apr 1890 m Mr. ANDERSON
- 1,125 ii Mable M Callen- b Aug 1892
- 1,126 iii John William Callen- b Oct 17, 1893
- 1,127 iv Charles Josiah Callen- b Jan 28, 1897
- 1,128 v Thomas "Wayne" Callen- b June 5, 1899
- 1,129 vi James LeRoy "Lee" Callen- b Dec 28, 1901

obituary of JAMES A CALLEN
(newspaper article from Armstrong Co.)

"Templeton, May 6. - Funeral services for James Callen, who died Friday morning at Armstrong County Hospital following an illness of several weeks, were held Monday afternoon at 2 o'clock in Templeton Methodist church.

Services were in charge of Rev. Walter Kennedy and Rev. H.F. Pollock. The church choir sang "Some Bright Morning" and "Good Night and Good Morning. "Burial was made in Belknap Cemetery. Casket bearers were James Aharrah, W.J. Reedy, Harry R Bowser, Ralph Hopper S.E. Wagner and Charles Cochran."



1,59-JOSIAH P CALLEN/ John/ Thomas/ Hugh Sr/ Patrick Callen

(6)According to his death certificate "SI" CALLEN was born July 3, 1868 in Washington Twp, Butler Co, Pa; but the census records for 1870 and 1880 show that he wasn't born until 1870 or 1871. He was the son of John and Mary Ann (Redic) Callen.

Josiah married the widow MRS. LAURA BELLE SMITH, who had 7 children by her previous marriage. They had no children of their own. He worked for Rumbaugh Grain. (26)Si died December 29, 1942 of heart failure, Laura died February 25, 1936, they are both buried in Bear Creek Cemetery, Petrolia, Butler Co, Pa. Their tombstones are gone, but the base is still there according to Paul E Callen.

obituary of JOSIAH P CALLEN

(Butler Co, Pa newspaper)

"Josiah P Callen, aged 74, formerly of Petrolia, died at the residence of his nephew, Charles J Callen... at 9:45 o'clock last night. He was born in Washington township and had been a resident of Petrolia the greater part of his life. He was an oil field worker.

He leaves two brothers, James A Callen of Templeton and Charles Callen of Vandergrift.

The body has been removed to the Thompson Funeral Home, E North St at McKean St, where the family will receive friends... Funeral services will be held from the Thompson Funeral Home... with the Rev. H.O. Olney, pastor of the Baptist church of Butler, officiating. Burial will be in the Bear Creek Cemetery, Petrolia."

1,60-CHARLES H CALLEN/ John/ Thomas/ Hugh Sr/ Patrick Callen

CHARLES HERMAN CALLEN was born November 6, 1875, the son of John and Mary Ann (Redic) Callen. (33B)He was about 3 to 5 years old when his mother died and only about 13 when his father died, and he had to go to work for the railroad to support himself. He was 6' tall. Charles married his second cousin "JENNIE" ELIZA JANE NICHOLS (see 1,74).

He died November 28, 1957, in Westmoreland Co, Pa. (his death certificate erroneously show his parents as James and Elizabeth (Redic) Callen). Jennie died in 1944.

Children

- i Arthur H Callen- d ca 1962 in Vandergrift, Pa
married WILMA
- 1,130 ii Howard Maybon Callen- d ca 1942
- 1,131 iii Hazel Callen-b Aug 27, 1918

1,61-JOHN H CALLEN/ Josiah J/ Thomas/ Hugh Sr/ Patrick Callen

(29)JOHN H CALLEN was born January 16, 1866. He was a twin to James E. (11)He married LOTTIE O. SMITH who was born October 11, 1873. John owned half interest in Callen Brothers (barber shop?-see James E). John died May 3, 1901 and is buried in Ford City, Armstrong Co, Pa.

will of JOHN H CALLEN
(filed in Armstrong Co, Pa)

Know all men by these presents, that I, John H Callen of the borough of Ford City, County of Armstrong and state of Pennsylvania, being of sound mind and memory do make and publish this my last will and Testament.

First: I order that my body be suitably interred in a manner suitable to my estate and situation in life.

Second. As to such estate as it has pleased God to entrust me I dispose of the same as follows:

I give and bequeath to my beloved wife Lottie O. Callen all of my real estate and personal property including my partnership interest of one half of the business of Callen Brothers.

and I hereby Constitute and appoint my beloved wife Lottie O Callen my sole executrix of this my last will and Testament with full power and Authority over my said property and business.

In Witness whereof I John H. Callen the testator of this my will written on one sheet of paper, set my hand and seal this second day of May in the year of our Lord Nineteen hundred and one.

John H. Callen

Signed, sealed, published and declared by the above named John H Callen as and for his last will and testament in the presence of us who have hereunto subscribed our names at his request as witnesses thereto in the presence of the testator and of each other.

James E Callen; J.J. Callen; Alford L Ivory

1,62-JAMES E CALLEN/ Josiah J/ Thomas/ Hugh Sr/ Patrick Callen

(29)JAMES ESPY CALLEN was born on (6)January 16, 1866, he was a twin to John H. (11)He married MARGARET EMMA CORNMAN who was born August 10, 1869.

James was a barber, and operated a barber shop out of his home. (6)He was "found dead sitting on a sofa in his barber shop... September 29, 1940", aged 74 years. He is buried in Ford City, Armstrong Co, Pa. Emma died before James, date unknown.

Children

(not necessarily by order of birth)

- i Almira Callen- m WINSOR W BROWN
- ii Caroline Callen- m EDWARD D O'DENBAUGH Jr.
- iii son-b Nov 26, 1905 apparently died young

Will of JAMES E CALLEN
(filed Armstrong Co, Pa)

I, James E Callen, of Ninth Street, Ford City, Armstrong County, Pennsylvania, being of sound and disposing mind, do hereby make this, my last will and testatment.

To my daughters Almira, Mrs. Winsor W. Brown, now residing at ... Champaign, Illinois, and Caroline, Mrs. Edward D Odenbaugh Jr, now residing at ...New Kensington, Pa., I bequeath all real and personal property of which I die possessed, to be shared equally by them, their heirs and/or assigns.

I hereby name and appoint my son-in-law, Edward D. Odenbaugh, Jr., now residing at ...New Kensington, Pa., executor of this, my last Will and Testament, made by me at Ford City, Armstrong County, Pennsylvania, this 13th day of October in the year of our Lord one thousand nine hundred and thirty-eight.

James E. Callen
Testator

Witnesses:

R.C. McKelvy
J.W. Delp

1,63-DAVID O CALLEN/ Josiah J/ Thomas/ Hugh Sr/ Patrick Callen

DAVID O CALLEN appears to have been born on December 31, 1867 (his death certificate says he was 56 years, 7 mo and 18 days old). He was born in Madison Twp, Armstrong Co, Pa, the son of Josiah J and Mary Ellen (Cowan) Callen. He married SINA EARLY who was born (29)September 1868. By occupation David was a millwright and worked for the U.S. Aluminum Co.

(4)David died in Pittsburg, Allegheny Co, Pa on July 18, 1924. His will is filed in Westmoreland Co, Pa. He named his daughters as executrixs. Sina died May 2, 1933 in New Kensington, Westmoreland Co, Pa, she also named her daughters as executrix of her will.

Children

- i Eva Callen-b Mar 1891 m Mr. McCUTHEON
- ii Ella Callen-b June 1893 m Mr. WENGER
- iii Bertha Callen-b Mar 1898

1,64-CHARLES T CALLEN/ Josiah J/ Thomas/ Hugh Sr/ Patrick Callen

(11)CHARLES T CALLEN was born April 5, 1871, the son of Josiah J and Mary Ellen (Cowan) Callen. He married ADA (unknown) who was born (29)August 1869.

Charles died November 25, 1897, age 26 leaving a pregnant wife, he is buried in Kellersburg, Armstrong Co, Pa. It appears that after Charles death his father, Josiah J, became the guardian of Charles youngest three children even though Ada was still living; and after the death of Josiah in 1916, Charles brother James was chosen as their guardian. In 1900 this family was living in Fawn Township, Allegheny Co, Pa.

Children

- i Mary L Callen-b May 1890
- ii Ida Bell Callen-b July 28, 1895 m WAYNE LOGAN
- iii Hurlbert James Callen-b Apr 1897
- iv Charles Thomas Callen-b May 1898

1,65-MARY E J CALLEN/ Thomas J/ James/ Hugh Sr/ Patrick Callen
(1-36A)MARY ELIZA JANE CALLEN, called "JENNIE" was born April 11, 1871, the daughter of Thomas J and Clarissa L (Smith) Callen. She married DAVID HUNTER BASHLINE, a farmer, who was born January 17, 1865. Jennie died January 22, 1949, Hunter died July 19, 1935 both are buried in Sligo, Clarion Co, Pa.

Only Child

- 1,132 i Lillie Blanche Bashline-b Jan 19, 1893

1,66-HUGH S CALLEN/ Thomas J/ James/ Hugh Sr/ Patrick Callen
(36A)HUGH SMITH CALLEN was born September 20, 1872 the son of Thomas and Clarissa (Smith) Callen. (1)"He is engaged in lumbering (and) lives in Reidsburg, Pa." (36A)He married MARY ELLA PETERS who was born on February 8, 1874.

Mary died February 18, 1925, Hugh died February 1929; both are buried in Sligo, Pa.

Children

- 1,133 i Raymond Arthur Callen-b July 20, 1893
- 1,134 ii Twyla Odella Callen-b Nov 1895
- 1,135 iii Bertha Lorraine Callen-b Sept 1, 1897
- 1,136 iv Donald Hugh Callen-
v Frances Callen-b 1904 d 1904

1,67-CURTIS E CALLEN/ Thomas J/ James/ Hugh Sr/ Patrick Callen
(1-36A)CURTIS EDWARD CALLEN was born February 23, 1874, the son of Thomas J and Clarissa L (Smith) Callen. "is engaged in lumbering in Jefferson county". He married ANNIE KING on (33D)December 26, 1899 in Kittanning. She was born March 29, 1876. (36B)After Annie's death on May 4, 1950 he married Mrs. MARY SILVES on October 12, 1950. Curtis died February 25, 1955.

Children

- 1,137 i Thomas Edward Callen-b Apr 25, 1904 d Sept 13, 1904
- 1,137 ii Ethel May Callen-b Sept 19, 1905
- 1,138 iii Pearl Arzula Callen-b Mar 29, 1908
- 1,139 iv Nellie Irene Callen-b Dec 4, 1912
v daughter- died at birth

1,68-VERDA L CALLEN/ Thomas J/ James/ Hugh Sr/ Patrick Callen
(1-36A)VERDA LOUEMMA CALLEN was born February 18, 1878. She married WILLIAM EDWARD SEIFERT (33I)on October 18, 1899. Verda died February 27, 1953.

Only Child

i Carl Brainerd Seifert- died when small

1,69-JAMES H CALLEN/ Thomas J/ James/ Hugh Sr/ Patrick Callen
(1-36A)JAMES HARRY CALLEN was born February 15, 1880, the son of
Thomas J and Clarissa L (Smith) Callen. He married LAURA BETZ who
was born (29)April 1880. (11)James died February 5, 1923.

Children

1,140 i Harold Callen-b (infant born Mar 1900?)
1,141 ii Jay Callen-b Feb 9, 1902
1,142 iii Kenneth Callen-b Aug 24, 1913

1,70-WILLIAM E CALLEN/ Thomas J/ James/ Hugh Sr/ Patrick Callen
(1-36A)WILLIAM ELLSMORE CALLEN was born November 22, 1883 the son
of Thomas J and Clarissa L (Smith) Callen. By occupation he was a
miner. He married BESSIE HENRY (33I)who was born November 19, 1905.
William died January 4, 1919, Bessie died December 11, 19__.

Children

1,143 i William C Callen- lived in Pittsburg
1,144 ii Helen Callen-
1,145 iii Darl H Callen- served in WWII?
1,146 iv Sarah Callen-

1,71-ZULA CALLEN/ Thomas J/ James/ Hugh Sr/ Patrick Callen
(1-36A)ARMINTA ARZULA "ZULA" CALLEN was born October 14, 1886 the
daughter of Thomas J and Clarissa L (Smith) Callen. She married
(33I)JOHN OVER. Zula died April 28, 1963.

Children

1,147 i Merl Over-
1,148 ii Clara Over-
1,149 iii Ruth Over-
1,150 iv Elmer Over-

1,72-ELMO HUGH CALLEN/ Hugh W/ Samuel/ Hugh Sr/ Patrick Callen
(34B)ELMO HUGH (or HUGH ELMO?) CALLEN was born July 2, 1873 in
Clarion Co, Pa. He was the son of Hugh W Callen and first wife Mary
of Olean, N.Y. Elmo married NELLIE GRACE CLINE who was born October
11, 1879 in Hillville, Pa. Elmo died September 1958, Nellie died
April 17, 1946. Both are buried in Memorial Park Cemetery, Butler.
Pa.

Children

(not necessarily by order of birth)
i Pearl Callen-b Nov 1898 m Mr DUFFER lived Butler Pa
1,151 ii Donald Rickard Callen-b Jan 8, 1908
iii Rudy E Callen-b 1910 d 1964
buried in Memorial Park, Butler, Pa

- 1,152 iv Charles Freeman Callen-b July 23, 1917
 v Mary Callen- m Mr COMPTON lived in Pennington N.J.
 vi Ruth Callen- m Mr WANGAMAN lived in Washington, Pa
 vii Margaret Callen- lived in Butler Pa
 viii Louise Callen- Mr RIFENBERRICH lived Partensburg Pa

1,73-HARRY E CALLEN SR/ Hugh W/ Samuel/ Hugh Sr/ Patrick Callen
 HARRY EARL CALLEN, SR was born in 1878, the son of Hugh W and Mary
 (Stratton?) Callen. (34A)He was "married to SADIE NAOMI FENNELL,
 from Armstrong Co adjacent to Butler Co. He was a farmer, a very
 fine man, a Christian." Harry died 1965.

Children

- i Frank Callen-
 ii Elma Callen-
 iii Margaret Callen-
 iv Loretta Callen-
 v Dorothy Callen-
 vi Naomi Callen-
 1,153 vii Harry Earl Callen Jr-b ca 1920
 viii Edward Callen-
 ix Betty Callen-

1,74-JANE ELIZA NICKOLS/ Sarah L Callen/ Hugh Jr/ Hugh Sr/ Patrick
 Callen

(33B)"JENNIE" ELIZA JANE NICKOLS was born April 13, 1878 the
 daughter of Sarah L (Callen) and Ross S Nickols. She married her
 2nd cousin CHARLES HERMAN CALLEN (see 1,60).

Children

- i Arthur H Callen- m WILMA
 d 1963 in Vandergrift, Pa
 1,130 ii Howard Maybon Callen-
 1,131 iii Hazel Ruth Callen-b Aug 27, 1918



?, JENNIE, CHARLES
 HAZEL

1,75-FREDERICK A CALLEN/ John H/ Watson/ Hugh Sr/ Patrick Callen
(35A)FREDERICK ALVIN CALLEN was born April 16, 1865 in Brockport,
Elk Co, Pa; the son of John H and Hazel Adaline (Mohney) Callen.
(35N)On December 25, 1886 in Brookville, Jefferson Co, Pa he married
ANNIE ESTHER DODSON who was born July 26, 1864 in Kittanning, Pa.

(35A)Frederick served as Sergent of the Guard for the Sons of
Veterans organized May 14, 1884 under Capt Charles McLain's Co 16.

(29)In 1900 they were living in Oliver Twp, Jefferson Co, Pa. Annie
died February 27, 1946 (35M)and is buried in Tanasket, Wa, Fredrick
died December 2, 1962 and is buried in Republic, Wa.

Children

- i Eldon Clifford Callen-b Jan 6, 1888 d Jan 5, 1962
- ii Leona Volza Callen-b Feb 17, 1890 d Oct 25, 1907
- 1,154 iii Hazel Irene Callen-b Mar 25, 1892
- iv Frederick Earl Callen-b May 17, 1894 d Aug 16, 1916
- v Violet May Callen-b Apr 19, 1898
- vi Florence Gertrude Callen-b Apr 25, 1900 d Sept 1919
- 1,155 vii John Leonard Callen-b Dec 25, 1903
- viii Francis Melvin Callen-b May 4, 1906 d Jan 20, 1909

1,76-ANNA J CALLEN/ John H/ Watson/ Hugh Sr/ Patrick Callen
(35A-35B)ANNA JANE CALLEN was born October 16, 1866, the daughter
of John H and Hazel Adaline (Mohney) Callen. (35B)"Annie had polio
as a child, in the summer of 1879 when she was 12 years old and she
never grew any taller. She developed the deformed back so
characteristic of many polio victims. Her younger brother James W
was only five years old that same summer. He and Anna were sick all
summer; Jimmie died on August 24... My grandfather was just 3 1/2
years old at the time, but he could vividly remember how sick Anna
and Jimmie were. He remembered taking water to them and trying to
cheer them up..."

Anna was living in Warsaw, Pa in 1908. She died February 23, 1916.

1,77-WILLIAM T CALLEN/ John H/ Watson/ Hugh Sr/ Patrick Callen
(35A-35B)WILLIAM THOMAS CALLEN was born (29)April 1869, the son of
John H and "Adaline" (Mohney) Callen. He married LUCY RIGGS who was
born March 1870. They are shown in the 1900 census in Spring Creek
Township, Elk Co, Pa.

(35B)"William deserted his wife, Lucy, and their children and moved
to Oklahoma, took a common-law-wife Ida, and raised her children."
Lucy died in 1934 and is buried in Warsaw Twp, Jeff Co, Pa.

Children

- i George Callen-b Jan 1892
- ii Mary Pearl Callen-b Jan 5, 1894
- iii Adie Callen-b May 1896
- iv Rosco Callen-b Dec 1898

1,78-GEORGE W CALLEN/ John H/ Watson/ Hugh Sr/ Patrick Callen
(35B)GEORGE WALTER CALLEN was born March 1, 1876 the son of John H
and Hazel Adaline (Mohney) Callen. He married BLANCHE FLORENCE
BRUMBAUGH.



GEORGE W & BLANCHE
GWENDOLYN, CLEONE

"Granddad was quite the artist. He did some charcoal sketches of the barn on his father's farm... also a sketch of the cabin in the mountains that they built and used for many years when they went hunting. Granddad sketched these drawings in 1892 when he was just sixteen years old. The earliest drawings by Granddad were done when he was thirteen; they are of a "Thanksgiving turkey" he raised and of a favorite barnyard cat. They are so good! He loved to draw and paint; he never took a lesson and did it only for his own amusement and pleasure. He kept a great deal of what he did draw over the years and I have most of what remains. He seldom shared these accomplishments with others, and I am sure that he would be more than a little embarrassed to find them preserved, some of them framed and hung."

"Another cherished family heirloom I have is a few of the

tail feathers from the first wild turkey Granddad succeeded in bagging. He brought it home for a family dinner when he was six years old. Mom says that her grandmother told her that when he came home with the turkey he had to drag it, it was almost as big as he was. She kept a few of the feathers and gave them to my grandmother in the 1920's."

"He was a real scholar and had a huge library. Everytime he came to visit he brought each of us grandchildren a book or two. We always knew that for each birthday, each Christmas, and each holiday one of the presents we would receive from him would be a book. He always told us that it was a crime to burn, destroy, throw away, or mistreat a book. He said that books were the friends we could always depend on, he said they were the constant companion. His influence certainly bred a love for books in me."

"Granddad had a teaching degree: he went to Clarion State College. Although he never taught, he said the most valuable thing he had other than his children and grandchildren was his education.

George Walter died April 27, 1966.

Children

- i Gwendolyn Mardell Callen-
- ii Cleone Frances Callen-
- 1,156 iii Lucill Marie Callen-b 1911

1,79-MELVIN H CALLEN/ John H/ Watson/ Hugh Sr/ Patrick Callen
(35A-35B)MELVIN HARVEY CALLEN was born August 29, 1879, the son of John H and Hazel Adaline (Mohney) Callen. He married DOROTHY LEE AVANT, and they moved to Texas. Melvin died June 15, 1947 at Corpus Christi.

Children- (partial list)

- i Hazel Callen-b

1,80-LEON J CALLEN/ John H/ Watson/ Hugh Sr/ Patrick Callen
(35A-35B)LEON JOHN CALLEN was (31)born October 6, 1883. He married EDNA YOUNG.

Only Child

- i Harold Curtis Callen-b

1,81-PAGE CALLEN/ John H/ Watson/ Hugh Sr/ Patrick Callen
(35A-35B)HAROLD "PAGE" CALLEN was born October 3, 1893, the son of John H and Hazel Adaline (Mohney) Callen. He married LILLIAN H, who was born in 1879. Charlene Callen of Sacramento, "who knew her, [said] that Lillian was a very lovely and aristocratic woman of whom Grandma Adeline was very fond." Adeline lived with her son Page and Lillian after the death of her husband.

Lillian died in 1972 and Page died on November 15, 1984 in San Francisco, California a few days after having taken a fall. Lillian is buried in Wildwood Cemetery, in Brockwayville, and Page is probably buried beside her. They had no children

1,82-ARTHUR A CALLEN/ Alvin C/ Watson/ Hugh Sr/ Patrick Callen
(35C)ARTHUR ALEXANDER CALLEN was born July 14, 1878 and drowned in 1889, age 11 years.

obituary of ARTHUR A CALLEN

(probably from Brockwayville, Pa newspaper)

Monday morning the villagers were startled by the report that Arthur Callen, an 11-year-old son of Alvin Callen, was drowned in the creek above town. A number of men and boys at once proceeded to the spot where they found those who had preceeded them engaged in searching for the body.

The accident occurred early in the morning, probably between the hours of 6 and 7 o'clock. The boy, in company with his little brother, were hunting for their cow. On the creek bank opposite the connecting switch of the R & C and B, R & P railroads Arthur disrobed and waded into the creek. Whether he did so for the purpose of bathing or crossing the creek in further search of the cow is not known. The stream was swollen and muddy from the heavy rains of the previous night, and the water was continually rising.

The boy had taken but a few steps before he got beyond his depth. He was unable to swim and sank at once. The little lad on the bank was badly frightened and ran for home, fully a quarter of a mile distant. Mr. Callen was away at work, and it was some time before any men could be found. Even then the little fellow was so overcome by fright and exhaustion that he was unable to locate the spot where the accident occurred. It was mostly by searching up and down the creek bank that the place was located by finding the missing boy's clothing. A.W. Sibley and Dan Riley were among the first to reach the spot, and they waded and dove in the stream, but could find nothing. A boat was brought and with rakes attached to ag poles the bottom was dragged, but the water had risen so rapidly and the current was so swift but little headway could be made.

Several men then entered the stream and by wading and swimming engaged in the search. These were more successful, for at a bend in the creek about eight or ten rods below Theodore Levis touched the body with his foot and quickly brought it to the surface. It had lodged on a log and was in water four or five feet deep.

Although the body had been in the water over three hours attempts were made at resuscitation, which of course proved unavailing. The funeral took place on Tuesday forenoon.

1,83-EDWARD E CALLEN/ Alvin C/ Watson/ Hugh Sr/ Patrick Callen
(35C)EDWARD EVERETT CALLEN was born October 26, 1879-80 in Jefferson Co, Pa; the son of Alvin Cummings and Sarah Margaret (Bowdish) Callen. (31)He married OTILLIA ANNA GROB on April 15, 1902, in Sharpsburg, Allegheny Co, Pa.

Children

- i Dorothy Nora Callen-b Jan 1, 1910
- ii Margaret Callen- m Mr. DYE

1,84-CHARLES B CALLEN/ Alvin C/ Watson/ Hugh Sr/ Patrick Callen
(35F-35G)CHARLES BRUNSON CALLEN was born August 10, 1886 in Brockway, Pa. He was the son of Alvin Cummings and "Maggie" Sarah Margaret (Bowdish) Callen. By occupation he was a Methodist minister. He married MARY SOPHIA ROSE who was born February 9, 1885 in McKeesport, Pa. Charles died December 31, 1967, and Mary died November 12, 1978, both are buried in McKeesport, Pa.

Children

(not necessarily by order of birth)

- i David Callen-
- 1,157 ii William Charles Callen-b
- 1,158 iii Robert C Callen-b June 11, 1919
- iv Edna Callen
- 1,159 v Violet Callen

1,85-SAMUEL W CALLEN/ Alvin C/ Watson/ Hugh Sr/ Patrick Callen
(35A)SAMUEL WATSON CALLEN was born December 4, 1887 in Brockwayville, Jefferson Co, Pa. He was the son of Alvin Cummings and "Maggie" (Bowdish) Callen. He was christened on January 3, 1894 at the Methodist church in Brockwayville. On February 11, 1911, he married FLORENCE CECELIA SCHUCHMAN in Pittsburgh, Allegheny Co, Pa. Florence was born June 23, 1887.

By occupation Samuel was an interior decorator, and a minister at the Faubian Chapel Methodist Church in Linden, Mo in 1924-1925. Samuel died May 29, 1953, and Florence died August 28, 1962, both are buried in Fairview Cemetery, Liberty, Clay Co, Mo.

Children

- 1,160 i Velma Alverda Callen-b Dec 13, 1911
- ii Grace Kathryn Callen-b Nov 1913
- d Feb 1915 Pittsburgh Pa
- iii Samuel Watson Callen-b April 12, 1915
- d July 6 1916 Pittsburg, Pa
- 1,161 iv Samuel Watson Callen-b Aug 26, 1918
- v Florence Naomi Callen-b Aug 6, 1920
- m 1st Mr. ROBBINS 2nd Mr. CHARLTON
- 1,162 vi Alvin Cummings Callen III-b Dec 7, 1924
- vii Juanita Fern Callen-b Mar 22, 1928 m Mr. RAY

obituary of SAMUEL WATSON CALLEN
(newspaper unknown)

Samuel W Callen Rites

Funeral services for Samuel W Callen, 65 years old, who died Friday at the home,...will be held at 2 o'clock Wednesday at the Assembly of God church in Maple Park. Burial will be in Fairview cemetery, Liberty.

Mr. Callen was an interior decorator and was at work when he suffered a heart attack. He had lived in Clay County about thirty years and was a member of the Free Methodist church, Kansas City, Kansas. He was born at Brockwayville, Pa.

He leaves his wife, Mrs. Florence Callen of the home; three daughters, Mrs. Velma Allison... Mrs. Florence Robbins of the home, Mrs. Juanita Ray... two sons Samuel W Callen, [of] Shawnee, and Alvin C Callen... four brothers the Rev Charles Callen, Milton, O, Clyde B Callen, Watsonville, Calif. Philo L Callen, Seattle, and Edward Callen, Pittsburgh.

1,86-CLYDE B CALLEN/ Alvin C/ Watson/ Hugh Sr/ Patrick Callen
(35A)CLYDE BARTLETT CALLEN was born July 26, 1889 in Brockwayville, Pa, the son of Alvin Cummings and "Maggie" (Bowdish) Callen. He married GRACE FLYNN on March 26, 1912.

Children

1,163 i Harry Clyde Callen-

1,87-PHILO L CALLEN/ Alvin C/ Watson/ Hugh Sr/ Patrick Callen
(35J)PHILO LEROY CALLEN was born in Brockwayville, Pa on October 22, 1891, the son of Alvin C and "Maggie" (Bowdish) Callen. He married JOSEPHINE BROHAMER, who was born in Missouri. Josephine was a candymaker.

(35E)Philo's mother "died when Philo was very young. His father lived in Pittsburgh, and it was from there that the children were admitted to the Uniontown (Jumonville) Soldier's Orphans School; later transferred to the Soldiers' Orphans Industrial School at Scotland, where Philo graduated in 1910.

"At Scotland, Philo was a varsity member of the football and baseball teams. His pleasure here was, as most old timers will tell you, to play against the Carlisle Indians made famous by world renowned Jim Thorpe. He was a Sergeant in Company B of the school battallion before entering the band.

"A few years ago, Philo retired from the University of Washington in Pathology. Here he was the senior laboratory assistant in charge of preparing specimens. He had complete charge of the medical museum. Upon his retirement, his fellow employees gave a testimonial party at which time they presented him with a book of his past life styled after the famous Ralph Edwards television production "This is Your Life".

Since retiring, Philo finds time to do some carpentering, especially work in remodeling. His hobby is chiefly travel, and too, enjoys visiting the sick and helping those in need in any way possible.

And so, as were his ancestral families devoutly religious and extremely kind and generous people, we find these same qualities in Philo Callen, our friend and schoolmate."

(35J)Josephine died December 26, 1964, Philo died August 26, 1988, they are both buried in Renton, Washington.

Children

1,164 i Frederick Charles Callen-
1,165 ii Craig R Callen-
1,166 iii Marshall K Callen-b Oct 30, 1930

1,88-BERTHA J BIRD/ Sarah Callen/ Watson/ Hugh Sr/ Patrick Callen
(18)BERTHA JANE BIRD was born on March 27, 1874 at Snyder Hill and was taken to Luzerne Co. She was educated in the public schools at Brockport, Pa. On November 8, 1894 Bertha married HARRY BAIRD HUMPHREYS who was born on April 22, 1869 in Snyder Township.

(18)"Mr. Humphreys takes a lively interest in community affairs, his political allegiance being given to the Republican party. He and his wife are zealous members of the Methodist Episcopal Church at Lanes Mills, where he has been an effective and popular teacher in the Sunday School."

(35L)Bertha died around 1948 in Erie, Pa.

Children

- i Marshall B Humphreys-b Dec 20, 1900
- ii Nellie May Humphreys-b Feb 1902
- iii Kenneth Elwood Humphreys-b Feb 3, 1904
- iv Frances Lucille Humphreys-b Jun 4, 1906
- v Evelyn Luella Humphreys-b Jun 28, 1910
- vi Irene Bird Humphreys-b Oct 8, 1913



SARAH (CALLEN) & FRANCIS A BIRD (1,37); EDNA (YOUNG) CALLEN (1,80);
HARRY & BERTHA (BIRD) HUMPHREY (1,88); HAROLD PAGE CALLEN (1,81);
ANNA JANE CALLEN (1,76); ADALINE (MOHNEY) & JOHN H CALLEN (1,35)

1,89-CALLEN S BIRD/ Sarah Callen/ Watson/ Hugh Sr/ Patrick Callen
(35L)CALLEN STERLING BIRD was born in August of 1878 in Erie, Erie Co, Pa, the son of Anna S (Callen) and Francis A Bird. On September 4, 1899 he married MAUDE MOHNEY, they had 5 children. Callen was the veterinerian for the Raine Andrews Lumber Co. in Evenwood, W.V and cared for the large dray horses used in hauling the timber.

1,90-MARY L BIRD/ Sarah A Callen/ Watson/ Hugh Sr/ Patrick Callen
(35L)MARY LUELLA BIRD was born in March of 1882, the daughter of Sarah A (Callen) and Francis Bird. Mary married MACK McKELVEY who may have died, and later in 1918, she married Dr. VICTOR HUMPHREYS who, being overworked, shot himself during the terrible Flu epidemic of 1918-1919. Mary was a Nurse, moving first to Erie, Pa where she worked as a nurse at the General Electric Co, later moved to California where she lived near Harry. She died in Bakersfield, Ca sometime between 1930 and 1940.

1,91-GEORGE A BIRD/ Sarah Callen/ Watson/ Hugh Sr/ Patrick Callen
(35L)GEORGE ARLINGTON BIRD was born in December of 1885. George (18)"of Erie, Pa., married LILLIAN TEETERS" (35L)a local West Virginia woman.

Children

- i Hubert Bird-b Evenwood, WV
- ii Georgia Bird-b Evenwood, WV
- iii Louis Bird-b Evenwood, WV
- ix Neil Bird(female)-b Erie, Pa

1,92-CLYDE C BIRD/ Sarah A Callen/ Watson/ Hugh Sr/ Patrick Callen
(35L)"CLYDE CLIFTON BIRD, the son of Francis and Sarah (Callen) Bird, was born February 18, 1889 in Brockport, Jefferson Co, Pennsylvania. He was educated in Jefferson Co., living in several small towns within the County; Brockport, Lanes Mills, and Brockwayville.

"Clyde and his brothers were interested in music and played types of horns in the town bands. They also sang in the church choirs in whatever town they were living. The family were devout Methodists.

At the age of 14, Clyde moved with the family to a new lumber camp in West Virginia, to be named at a later date, Evenwood located in Randolph Co., about 20 miles from the county seat of Elkins, WV. Here he worked in the timber at various jobs. And for his enjoyment played the Cornet in the Raine Andrew Lumber Co. symphony and marching band which consisted of 45 members.

"Here, in Evenwood, West Virginia, he married on June 30, 1913 to EVA BESSIE ROSENCRANCE, daughter of John and Mary Elizabeth (Pingley) Rosencrance. Two of their children were born in Evenwood. Timber became scarce in 1917 and the Raine Andrews Lumber Co closed their operation.

"During World War I a new General Electric Plant was being built in Erie, Pa and workers were needed for the war effort. Again the entire families moved to this new venture seeking work. Clyde was employed in the Shipping Dept. on October 15, 1917. The other brothers also were employed at various jobs. A new town, later named Lawrence Park, was built by the G.E. Co...

"Clyde was an active participant in the new town and was active in civic, church and especially the Lawrence Park Volunteer Fire Department, later being named a Captain. On a Saturday afternoon, March 24, 1928, at age 39, Clyde was killed fighting a fire in the Power House of the General Electric Co. Clyde's wife Eva, died 2 years later, September 3, 1930 of kidney failure. They left 3 young children orphans.

Children

- 1,167 i John Francis Bird-b Apr 17, 1914
 ii Sarah Yvonne Bird-b Apr 29, 1916
 m WALLACE J DOWLING
 iii Edgar Victor Bird-b Feb 3, 1918
 m DOROTHY C COMLEY in 1941

1,93-HARRY R BIRD/ Sarah A Callen/ Watson/ Hugh Sr/ Patrick Callen
 (35L)HARRY RAY BIRD was born in January of 1892, the son of Sarah A (Callen) and Francis A (Bird). He enlisted in the Army July 17, 1911. He served as an Artillery Man in the Philippines until he was discharged, July 26, 1914 in California where he stayed for the remainder of his life. He later married ADAH____ (Unknown). There are no known children.

1,94-JAMES RAYBURN/ Calvin/ James/ Eleanor Callen/ Patrick Callen
 (9)"JAMES RAYBURN is a member of the Armstrong county bar and has already established for himself a good practice, rapidly attaining a high standing among the lawyers of the county. He was married on May 19, 1914, to ISADORA REYNOLDS, a daughter of the late Ross Reynolds, a distinguished member of the Armstrong county bar. His preliminary education for the study of the law was obtained in the Kittanning Academy and at Lawrenceville School, in New Jersey."

1,95-IDA STEELE/ Sarah Rayburn/ Matthew/ Eleanor Callen/ Patrick Callen

(32)IDA STEELE was born Feb 25, 1882, the daughter of Eugene and Sarah (Rayburn) Steele. Around 1902 she married HARRY WOOD CRYTZER who was born September 4, 1877 in Allegheny Co, Pa, son of Harmen B and Rosa D (Wood) Crytzer. Harry was Episcopalian in religion, he was paymaster at the Allegheny Steel & Kountz Bros Brickyard.

Children

(not necessarily by order of birth)

- 1,168 i Adelaide Roseland Crytzer-b Sept 6, 1914
 ii Richard Crytzer-
 iii Harry Crytzer-
 iv Florence Crytzer- m WILLIAM SWEENY
 v Virginia Crytzer- m JOHN KALLENBORN
 vi William Crytzer- m LOUISE ALLEN
 vii Mary Crytzer- died young
 viii Marcella Crytzer- died young

1,96-LEIGH B CALLEN/ David D C/ James F/ David/ Patrick Callen
(37F)LEIGH BATES CALLEN was born April 11, 1879 in Madison, Kansas. On May 16, 1906 in Leoti, Kansas he married NELLIE ALMIRA DEWEY who was born December 15, 1882 in Dickenson Co, New York. Nellie died July 19, 1961, Leigh died less than 4 months later on November 2, 1961; they are both buried in the Kohlerlaw Cemetery in Nampa, Idaho.

Children

- i Clifford Callen-b
- ii Wilbur Callen-b
- iii Chester Callen-b
- 1,169 iv Franklin Leigh Callen-b Feb 2, 1907
- v Mabel Annagrace Callen-b
- vi Mary Louise Callen-b
- vii Nellie Catherine Callen-b
- viii Elsie Maud Callen-b
- ix James Milton Callen-b Jul 19, 1927

1,97-IONA B CALLEN/ Elliot N/ William/ David/ Patrick Callen
(37E)IONA BARBARA CALLEN was born June 9, 1875 in Adams County, Iowa. She was the daughter of Elliot N and Nancy (Nutter) Callen. Iona married on May 9, 1906 to FRED FOWLER. There were no children to this marriage. Fred died January 25, 1919 in Sioux Falls, S.D.

1,98-EDNA D CALLEN/ Elliot N/ William/ David/ Patrick Callen
(37E)EDNA DAISY CALLEN was born May 11, 1878 in Adams Co, Iowa. She was the daughter of Elliot N and Nancy (Nutter) Callen. Edna married JOSEPH TRAVIS SWEET on December 15, 1903. Joseph died May 15, 1912 and is buried in Chicago, Illinois.

Only child

- i Earl Reed Sweet-b Mar 17, 1908 Chicago, Ill

1,99-GEORGE CALLEN/ Elliot N/ William/ David/ Patrick Callen
(37E)GEORGE CALLEN was born in Corning, Iowa on January 14, 1882, he was the son of Elliot N and Nancy E (Nutter) Callen. George was a carpenter like his father. In November of 1917 George married FLORENCE BARBARA VOGEL in St. Louis, Mo. Florence was born in March 1890 in St. Louis, she was a housewife and also worked at the St. Louis City Hall. George died July 1955; Florence died October 17, 1975.

Children

- 1,170 i Julia Nancy Callen-b Aug 21, 1918
- 1,171 ii Georgia Jane Callen-b July 21, 1921
- 1,172 iii John Elliott Callen-b Dec 4, 1925

1,100-ARTHUR R CALLEN/ Elliot N/ William/ David/ Patrick Callen
(37E)ARTHUR ROSCOE CALLEN was born December 4, 1886? in Omaha
Nebraska, son of Elliot N and Nancy (Nutter) Callen. He married ORA
SUMMERS at Poplar Bluff, Mo. She was born March 24, 1913.

Only child

i Edna Jean Callen-b May 18, 1931 Poplar Bluff, Mo

1,101-EDITH CALLEN/ Elliot N/ William/ David/ Patrick Callen
(37E)EDITH CALLEN was born July 26, 1887? in Omaha, Nebraska. She
was the daughter of Elliot N and Nancy (Nutter) Callen. She married
ROBERT CARR (there is a street in St Louis named for him) they were
divorced. Edith was very interested in her family heritage and
gathered a lot of information that has been passed on to us by her
nephew John E Callen.

Exerpt from letter sent to Edith:
"Boise, Idaho, Jan. 29, 1947

I am sorry to have waited so long to answer your letter. I can't
give you any information about Callen's except grandma, she was
buried near Prescott in a cemetery about 3 miles north but I don't
know the name of it. I've heard Ma say her grandmother was a
Fleming but that's all I know. There is a little town named
Callensburg in Pennsylvania and Ma said grandpa's father gave an acre
of land for the school house there & the town was named after him. I
saw the name of a Callen woman in a town near here - her name is
Elsie M. Callen...Nampa, Idaho. I always search telephone
directorys for the name & that's the first one I've found. She
might be a relative. One uncle who lived at Benton, Iowa had a
large family. If you'd address Mr. Callen, Benton, Ia, you might
get some information. I forget that uncles name. There are some
relations near Peoria Ill. I have the names of Joe, Arthur, James,
of Sparland, Ill, near Peoria- they should have left plenty of
decendents. Emma Card could tell you lots...

This is a lovely city (small) but full of soft coal smoke in winter.
There are such lovely trees, an estimated 55000 in the town. The
streets are lined with them. I hope you have good luck with your
family tree. I wrote down what little Ma told me.

Love & best wishes to all,
Gussie Fleming"

1,102-EVELYN CALLEN/ Elliot N/ William/ David/ Patrick Callen
(37E)EVELYN CALLEN was born December 24, 1889 in Omaha, Nebraska,
the daughter of Elliot N and Nancy (Nutter) Callen. She married
Doctor J.B. MCKINNEY (a medical doctor).

Children

i Jessie Evelyn McKinney-b Feb 9, 1913
ii Paul George McKinney-b Mar 21, 1918

1,103-FAYE CALLEN/ Elliot N/ William/ David/ Patrick Callen
(37E)FAYE CALLEN was born January 15, 1891 in Omaha, Nebraska, the daughter of Elliot N and Nancy (Nutter) Callen. She married GEORGE WOLF who was a judge in Clayton, Mo. "Faye's second husband was O.J. BACKENSTOCE."

Children

- i Audrey Ellen Wolf-b Jan 29, 1910
- ii George Wolf-b Jan 8, 1916

1,104-IDA A BELDING/ Mary L Callen/ William/ David/ Patrick Callen
(37E)IDA A BELDING was born in Corning, Iowa on July 24, 1876, the daughter of Mary L (Callen) and Elmer Belding. On March 11, 1902 she married JOHN A ANDERSON. John Anderson died September 1944.

Children

- 1,173 i Alfred Anderson-b Dec 22, 1902
- ii Alice Mary Anderson-b Dec 25, 1904
 - m WALTER COCHRAN on Feb 1, 1945
- iii Louise Isabelle Anderson-b Nov 21, 1912

1,105-AUGUSTA A BELDING/ Mary L Callen/ William/ David/ Patrick Callen

(37E)AUGUSTA A BELDING was born September 14, 1880, the daughter of Mary L (Callen) and Elmer Belding. On January 25, 1902 she married WILLIS M FLEMING. Willis died February 2, 1920. They lived in Stockton, California.

Children

- i Hugh Belding Fleming-b Apr 2, 1903
- ii Lawrence Belding Fleming-b Jul 29, 1904
- 1,174 iii Charles Ryker Fleming-b Dec 19, 1905
- 1,175 iv Russel Fleming-b Sept 3, 1909

1,106-NELLE BELDING/ Mary L Callen/ William/ David/ Patrick Callen
(37E)NELLE BELDING was born May 2, 1882, the daughter of Mary L (Callen) and Elmer Belding. On February 23, 1914 she married CLEO Z SPURRIER. They lived in Story, Wyoming.

Children

- i Eleanor Spurrier- still-born Jan 23, 1916
- ii Richard Belding Spurrier-b Jun 26, 1921

1,107-THEROU E BELDING/ Mary L Callen/ William/ David/ Patrick Callen

(37E)THEROU ELMER BELDING was born July 11, 1883, the son of Mary L (Callen) and Elmer Belding. On December 25, 19__ he married GRACE HAPPE. Grace died March 24, 1916. Therou married 2nd about January 1923 to NELLE LATIMER SHAW, there were no children to this marriage.

Only child

i Mary Catherine Belding-b Jan 1916 d age 12 days

1,108-OSCAR M BELDING/ Mary L Callen/ William/ David/ Patrick Callen

(37E)OSCAR MILTON BELDING was born September 28, 1885, the son of Mary L (Callen) and Elmer Belding. On March 3, 19__ he married ALICE McLAUGHLIN. Oscar died in Omaha Nebraska on April 2, 19__.

Adopted daughter

i June Belding-

1,109-RALPH W BELDING/ Mary L Callen/ William/ David/ Patrick Callen

(37E)RALPH WALTER BELDING was born on April 10, 1893 in Omaha, Nebraska. He was the son of Mary L (Callen) and Elmer Belding. On May 21, 1929 he married MARY MILDRED BROWNING. They lived in Sheriden, Wyoming.

Children

- i Mary Louise Belding-b Jan 18, 1931
- ii Anna Ida Belding-b Feb 2, 1932 d Nov 7, 1933
- iii Sara Raephine Belding-b July 6, 1935
- iv Charles Belding-b Nov 21, 1936
- v Thomas Belding-b Oct 15, 1941

1,110-CLAUDE C CALLEN/ Alva B/ Arthur F/ David/ Patrick Callen

(37B)CLAUDE CHRISTY CALLEN was born April 1, 1880 "3 1/2 miles south of Humeston, Iowa". He was the son of Alva B and Jennie (Clark) Callen. Claude married HENRIETTE FREDERICKKA JENSEN on July 3, 1911, in Des Moines, Iowa. Henriette was born November 24, 1882 in Atlantic, Iowa, the daughter of Soren M and Anna M (Schack) Jensen. There were no children. They lived in Omaha, Nebr.

Claude was very interested in his family heritage and did extensive research on the Callen family tree. Around the 1950's he compiled a 200 page book on his research. Some of that information is contained in "The Callen Chronicles" having been passed on to us by his cousins.

1,111-JOSIE A CALLEN/ Alva B/ Arthur F/ David/ Patrick Callen

(37A-37B)JOSIE ALVA CALLEN was born October 3, 1882, the son of Alva B and Jennie (Clark) Callen. He married STELLA MAY SQUIRES on March 6, 1907. Jose died October 23, 1921 in Mitchell, S.D.

Only Child

- i Gladys Callen-b June 24, 1908 school teacher
- m VERNON LAWSON on June 8, 1937

1,112-HATTIE B CALLEN/ Alva B/ Arthur F/ David/ Patrick Callen
(37A-37B)HATTIE BELLE CALLEN was born July 4, 1884 the daughter of Alva B and Jennie (Clark) Callen. She married Albert J. "BERT" JOHNSON of Vermillion, S.D. on November 27, 1907. Hattie lived to be 100 years old.

Children

1,176 i Guelda Mae Johnson-b July 13, 1911
ii Alberta Verle Johnson-b Nov 9, 1920 d Aug 20, 1922
died from swallowing a safety pin

1,113-EDWARD E CALLEN/ David D/ Arthur F/ David/ Patrick Callen
(37A)EDWARD ELLSWORTH CALLEN was born February 20, 1891 in Clio, Iowa; he was the son of David D and Jessie (Brooks) Callen. Edward married EUNICE CYNTHIA DOLBOW who was born June 1, 1890 in Bloomington, Illinois. Edward died May 11, 1920 in Isabel, Kansas.

Children

1,177 i Donald Dewitt Callen-b June 2, 1916
1,178 ii Tony Vern Callen-b Oct 27, 1918

1,114-OTTO O CALLEN/ David D/ Arthur F/ David/ Patrick Callen
(37A)OTTO OREL CALLEN was born August 31, 1893 in Clio, Iowa, he was the son of David D and Jessie B (Brooks) Callen. On September 14, 1914 he married CORA WENDT who was born on October 12, 1896 in Ruthven, Iowa. Otto was a railroad conductor, Cora was a homemaker. Cora died May 4, 1935 in Murdo, South Dakota; Otto died December 29, 1971 in Fremont, California.

Children

(all born in Murdo, Jones Co, South Dakota)
1,179 i Vernon Irving Callen-b Oct 29, 1916
1,180 ii Gwenleen Mary Callen-b Sep 28, 1918
1,181 iii Lloyd Lonnie Callen-b Dec 14, 1921
1,182 iv Bessie Belle Callen-b Dec 3, 1925

1,115-CLEO P CALLEN/ David D/ Arthur F/ David/ Patrick Callen
(37D)CLEO PAUL CALLEN was born in Benton, Iowa on September 12, 1896. On August 14, 1917 in Medicine Lodge, Kansas he married JOSEPHINE NELLE MEASE who was born February 27, 1895 in Galina, Missouri. Cleo worked for the Southwestern Bell Telephone Co.

Cleo died November 9, 1960; Josephine died in 1975, both died in Isabel, Kansas.

Children

1,183 i Kathleen Phylis Callen-b Oct 21, 1918
1,184 ii Delbert Rene "Bob" Callen-b Aug 9, 1920
1,185 iii Lonnie E Callen-b Mar 31, 1929

1,116-HAROLD V CALLEN/ David D/ Arthur F/ David/ Patrick Callen
(37A)HAROLD VERNE CALLEN was born January 28, 1899 in Benton,
Iowa; he was the son of David D and Jessie (Brooks) Callen. On
July 29, 1922 he married CHARLOTTE A BRONTE in Isabel, Kansas.
Charlotte was born February 16, 1900 in Peoria, Illinois.

Only Child

1,186 i Beth Margene Callen-b Dec 7, 1928

1,117-ARTHUR F CALLEN/ David D/ Arthur F/ David/ Patrick Callen
(37A)ARTHUR FLEMING CALLEN was born in Stafford, Kansas July 16,
1907, the son of David D and Jessie (Brooks) Callen. On August 29,
19__ he married his first wife ANNA MCGANN. There were no children
by this marriage. He married his second wife REGINA BERNICE FURY
on June 8, 1944 in Garden City, Kansas.

Children

i David Patrick Callen-b Nov 11, 1948 Garden City
ii Linda Jayne Callen-b Aug 15, 1951 Garden City

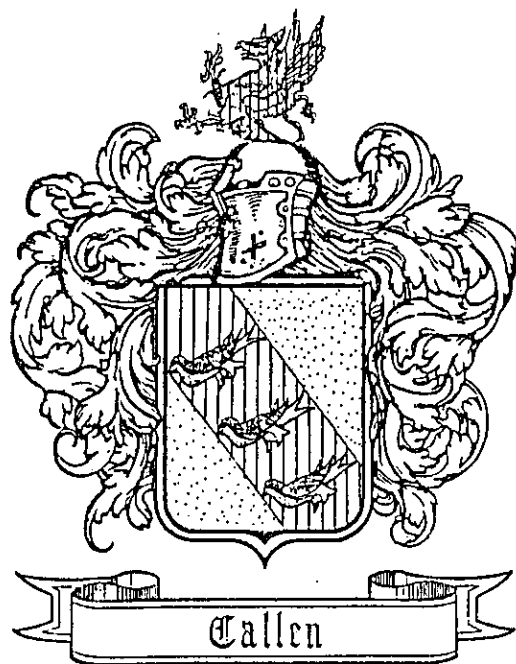

LINE OF PATRICK CALLEN - 6TH GENERATION

1,118-PERLE CALLEN/ Alpheus/ Hugh/ Thomas/ Hugh Sr/ Patrick Callen
(33I)PERLE CALLEN was born November 2, 1877 in Sigel, Jefferson Co., Pa. He was the son of Alpheus and "Maggie" Margaret Aharrah. He married JOSEPHINE MAE HENDERSON, who was born May 5, 1881 in Sigel, Pa. She was the daughter of David Holloway and Elizabeth Annie (Hottel) Henderson.

(20)The Jefferson Co courthouse records say that Perle became a gold seeker in California, (33I)but his grandson reveals that "Perle Callen followed the oil booms from Oklahoma, Texas, and into California. He worked in the oil fields as tool pusher. He returned to Sigel, Pa. and built a general store." Josephine graduated and taught school at the Sigel Academy prior to her marriage.

(29)In 1900 they were living in Heath Twp, Jefferson Co, Pa.
(33I)Josephine died December 27, 1945. "After Josephine passed away, Perle married ELIZABETH BOWDISH from Brookville, Pa about 1948. So far, my information about her is limited, except I know she passed away about five years ago [ca 1985]."

Both Perle and Josephine are buried in Sigel, Jefferson Co, Pa.

Children

1,187 i Cecelia Leanna Callen-b Nov 5, 1902
1,188 ii William Alpheus Callen-b July 27, 1908

1,119-ROLLAND C CALLEN/ Henry H/ Hugh/ Thomas/ Hugh Sr/ Patrick Callen

(20)ROLLAND CHARLES CALLEN was born in 1891, the son of Henry H and Mary M Callen. Rolland died in 1921 and is buried in Mt Tabor Cemetery, Jefferson Co, Pa

Children

i Virginia Lee Callen-

1,120-EDWARD R STAHLMAN/ Blanch Callen/ Hugh/ Thomas/ Hugh Sr/ Patrick Callen

(33H)EDWARD R STAHLMAN was born in Sigel, Pa on September 6, 1894. He was the son of Blanch (Callen) and George Armstrong Stahlman. By occupation Ed was a farmer. In July 1918 at Gretna Green, Maryland he married MARGARET ELLEN DAVIDSON who was born at Martins Ferry, Ohio on August 18, 1900.

Edward died in Pittsburgh, Pa on February 2, 1955.

Children

1,189 i Paul Vance Stahlman-b June 14, 1919
ii Lucille Margaret Stahlman-b May 31, 1924
d Apr 7, 1966 m Mr. DUNHAM

1,121-CARL LACY/ Sarepta Callen/ John/ Thomas/ Hugh Sr/ Patrick Callen

(33B)CARL LACY was the son of Sarepta (Callen) and Mr. Lacy. He married EDNA (unknown). They moved to Akron, Ohio.

Children

- i Ellen Lacy-
- ii Ruth Lacy-
- iii Juanita Lacy-

1,122-BULAH CALLEN/ William T/ John/ Thomas/ Hugh Sr/ Patrick Callen

(33B-33G)BULAH CALLEN was the daughter of William T and "Fanny" (Foringer) Callen. Bulah married JOHN RUBLE, they lived in Toronto, Ohio, and it is believed she died around 1973.

Children

- i Alice Ruble-
- ii Francis Ruble-
- iii Paul Ruble-
- iv Violet Ruble-

1,123-BURL A CALLEN/ William T/ John/ Thomas/ Hugh Sr/ Patrick Callen

(33G)BURL ARTHUR CALLEN was born March 9, 1892, the son of William T and "Fanny" (Foringer) Callen. He was 6'2" tall. By occupation he was an oil field driller working for Libby-Owens-Ford.

In October of 1889 he married STASHIE (pronounced Stacy) TACKETT who was born January 5, 1902, the daughter of George and Frances (Lusher) Tackett. Burl died August 1968 in Clendenin, W. Va, Stashie was living in Clendenin in 1984.

Children

- i Orville Talmadge Callen-b June 1, 1918 d Feb 1978
soldier of WWII- drove tank
- ii Roy Eugene Callen-b Feb 20, 1922
- 1,190 iii Arthur Burl Callen-b Jan 19, 1930

1,124-DELLA CALLEN/ William T/ John/ Thomas/ Hugh Sr/ Patrick Callen

(33B)DELLA CALLEN was the daughter of William T and "Fanny" (Foringer) Callen. She married EARL THOMPSON and they lived in Charleston, W.VA. Della died in 1954.

1,125-MABLE M CALLEN/ James A/ John/ Thomas/ Hugh Sr/ Patrick Callen

(33C)MABLE M CALLEN was born (29)August, 1892 in Scrubgrass Twp, Venango Co, Pa. She was the daughter of James A and Bertha (Thompson) Callen. She married JOHN THOMAS MCGINNIS. Mable died

around 1912, probably in Venango Co, Pa.

Only Child

i Wayne McGinnis-b

1,126-JOHN W CALLEN/ James A/ John/ Thomas/ Hugh Sr/ Patrick Callen

(33F)JOHN WILLIAM CALLEN was born October 17, 1893 in Scrubgrass Twp, Venango Co, Pa. He was the oldest son of James A and Bertha (Thompson) Callen. He married MABELLE CLAIRE LAWTHER, who was born December 25, 1888 in Apollo, Pa. By occupation he was a steel worker. He was a veteran during WWI. John died November 4, 1969; Mabelle died November 26, 1976, both are buried in Vandergrift, Pa.

Children

1,191 i "Betty" Mary Elizabeth Callen-b Jun 14, 1924
1,192 ii Josephine Lee Callen-b Aug 24, 1926

1,127-CHARLES J CALLEN/ James A/ John/ Thomas/ Hugh Sr/ Patrick Callen

(34C)CHARLES JOSIAH CALLEN was born on January 28, 1897 on a farm near North Washington, Butler Co, Pa. He was the son of James A and Bertha E (Thompson) Callen. He married HULDA MARY THOMPSON, daughter of Samuel P and Hattie (Book) Thompson. Charles served in France during WWI, he was a private in the 148th Infantry 37th Division. By occupation Charles was a barber, and he operated a barber shop in North Washington for some time. He was also a drill press operator. In religion he was Baptist.

Charles died on February 12, 1947, Hulda died February 18, 1938, both are buried in the North Washington Cemetery. Hulda's headstone was erected around 1976 by her grandchildren.

Children

1,193 i Lloyd Trudell Callen-b Feb 9, 1920
1,194 ii Thompson LeMoyne Callen-b Sept 30, 1921
iii Thelma Belle Callen- d in infancy
1,195 iv Harold Edward Callen-b Jul 23, 1924
v Elsie Marie Callen- d in infancy
1,196 vi Walter Earl Callen-b Feb 15, 1929

1,128-T WAYNE CALLEN/ James A/ John/ Thomas/ Hugh Sr/ Patrick Callen

(33D-33E)THOMAS WAYNE CALLEN was born June 5, 1899, in Butler Co, Pa., the son of James A and Bertha E (Thompson) Callen. On August 26, 1920, in Kittanning, Pa, he married GOLDIE ALMEDA HEPLER, who was born May 28, 1901 in Newmansville, Pa. By occupation Wayne was a steel mill worker, Goldie was a housewife and a glove factory worker. Wayne died January 15, 1965; Goldie died May 5, 1984. They are buried in the Greenwood Memorial Park Cemetery, in lower Burrell, Pa.

Children

- 1,197 i Dorothy May Callen-b Mar 11, 1922
- 1,198 ii Paul Ellsworth Callen-b Feb 20, 1924
- iii Everet Richard Callen-b Jul 2, 1926 d in infancy
- iv Robert Harold Callen-b Apr 28, 1928 d in infancy
- 1,199 v Elizabeth Matilda Callen-b Oct 13, 1930
- 1,200 vi Della Yvonne Callen-b Jun 15, 1933
- vii Shaffer Alexander Callen-b Apr 24, 1937 living in Ga

1,129-"LEE" CALLEN/ James A/ John/ Thomas/ Hugh Sr/ Patrick Callen
(33D)JAMES LEROY "LEE" CALLEN was born December 28, 1901. He
married AMARANTHA ESPY. Lee and Amarantha divorced. Lee died
November 25, 1962

Children

- i "Betty" Frances Callen- m ROBERT J JONES
- ii Paula Callen-

1,130-HOWARD M CALLEN/ Charles H/ John/ Thomas/ Hugh Sr/ Patrick
Callen

(33B)HOWARD MAYBON CALLEN was the son of Charles H and "Jennie"
(Nickols) Callen (Maybon was the name of the doctor that delivered
him.) He married ELEANOR (unknown). Howard died in 1942.

Children

- 1,201 i Roberta Louise Callen-b Jul 30, 1931
- ii Charles Hugh Callen-b Mar 4, 1938
- iii Mary Ruth Callen-b Mar 5, 1939 m RONALD MINESKY

1,131-HAZEL CALLEN/ Charles H/ John/ Thomas/ Hugh Sr/ Patrick
Callen

(33B)HAZEL RUTH CALLEN was born August 27, 1918, the daughter of
Charles H and "Jennie" (Nickols) Callen. She married "GUS" AUGUST V
BUCCIGROSSI who was born March 15, 1904.

Hazel worked as a waitress, and enjoyed family research. Her mother
had passed along several family heirlooms: including a Bible, sewing
machine, hymn book, and pictures. Her son now has these heirlooms.

Gus died December 31, 1975, Hazel died of cancer on March 4, 1984.

Only Child

- 1,202 i Charles David Buccigrossi-b Jan 26, 1944

1,132-BLANCHE BASHLINE/ Mary E Callen/ Thomas J/ James/ Hugh Sr/
Patrick Callen

(36A)LILLIE BLANCHE BASHLINE was the only child of "Jennie"
(Callen) and D Hunter Bashline. Blanche was born January 19, 1893.
On March 31, 1915 she married HERMAN DAY SILVES, who was born March
29, 1891. She belonged to the Methodist church and was church
organist for 35 years, retiring at age 80. Herman died April 27,

1945, and is buried in Sligo, Pa.

Only Child

1,203 i Frank Hunter Silves-b Dec 17, 1915

1,133-RAYMOND A CALLEN/ Hugh S/ Thomas J/ James/ Hugh Sr/ Patrick Callen

(36B)RAYMOND ARTHUR CALLEN was born on July 20, 1893 in Reidsburg, Pa, the son of Hugh S and Mary Ella (Peters) Callen. He served in WWI. Ray married JULIA MAE LOWE who was born on September 30, 1892 in Sligo, Pa.

His son James writes, "Raymond Arthur Callen known as R.A., Ray, Doughy (I have no idea how he got this name). Born in Reidsburg, Pa. on July 20, 1893, raised in Sligo, Pa., attended Sligo schools, further education was at Valparaiso University in Indiana.

"He started to work at Sligo National Bank on December 12, 1913 and retired after 45 years as Assistant Vice-President and Manager of the Sligo office of The First Seneca Bank and Trust Company which merged with the Sligo National Bank in 1954.

"He was Secretary-Treasurer of the Sligo School Board for 40 years. He was a member of the Sligo United Methodist Church and served as church treasurer for 25 years. He was a member of the Lion's Club, Masons, Odd Fellows and American Legion. He was a gentle quiet man."

Ray died April 10, 1973, Julia died on September 27, 1981; they are buried in the Sligo Cemetery, Pa.

Children

1,204 i Mildred Louise Callen-b Jun 30, 1920
1,205 ii James Russell Callen-b Feb 25, 1923
1,206 iii Robert Martin Callen-b Nov 14, 1925

1,134-TWYLA O CALLEN/ Hugh S/ Thomas J/ James/ Hugh Sr/ Patrick Callen

(33I)TWYLA ODELLA CALLEN was born November 3, 1895, the daughter of Hugh S and Mary Ella (Peters). She married ALPHEUS FLEMMING who was born September 12, _____. Alpheus died March 1955, Twyla died August 8, 1957.

Children

i Betty Flemming-b Nov 28, 1920
m Dec 31, 1954 DONALD MUIR CAIN
ii Bill Flemming-b Dec 11, 1921
m Dec 15, 1945 to BETTY SCHUMAN

1,135-BERTHA L CALLEN/ Hugh S/ Thomas J/ James/ Hugh Sr/ Patrick Callen

(33I)BERTHA LORRAINE CALLEN was born September 1, 1897, the daughter of Hugh S and Mary Ella (Peters) Callen. She married JAMES JACKSON SHAW.

Children

- i James Arthur Shaw-b Aug 16, 19__
- 1,207 ii Mary Elizabeth Shaw-b July 24, 1916
- 1,208 iii Robert L Shaw-b Apr 8, 1918
- 1,209 iv Frank Callen Shaw-b Apr 1820
- 1,210 v Richard Carl Shaw-b July 22, 1921
- 1,211 vi Joseph Hugh Shaw-b Feb 11, 1928
- 1,212 vii Erla Jane Shaw-b May 25, 1924
- 1,213 viii Bill A Shaw-b Oct 6, 1925
- ix Charles Shaw-b July 19__

1,136-DONALD H CALLEN/ Hugh S/ Thomas J/ James/ Hugh Sr/ Patrick Callen

(33I)DONALD HUGH CALLEN was the son of Hugh S and Mary Ella (Peters) Callen. He married PHEOBE RHEA, they had no children.

1,137-ETHEL M CALLEN/ Curtis E/ Thomas J/ James/ Hugh Sr/ Patrick Callen

(33I)ETHEL MAY CALLEN was born (33D)September 19, 1905, the daughter of Curtis E and Annie (King) Callen. She married HARRY JAMES CONNER on April 25, 1929. There were no children.

1,138-PEARL A CALLEN/ Curtis E/ Thomas J/ James/ Hugh Sr/ Patrick Callen

(33I)PEARL ARZULA CALLEN was (33D)born March 29, 1908, the daughter of Curtis E and Annie (King) Callen. She married WILLIAM HENRY SCHIFFGENS on August 12, 1936.

Children

- i Janet Pearl Schiffgens-b July 13, 1937
- ii Martha Ann Schiffgens-b Feb 10, 1939
- iii Lois May Schiffgens-b Aug 27, 1941

1,139-NELLIE I CALLEN/ Curtis E/ Thomas J/ James/ Hugh Sr/ Patrick Callen

(33I)NELLIE IRENE CALLEN was born December 4, 1912, the daughter of Curtis E and Annie (King) Callen. She married CLAIR WILSON FISCUS on November 15, 1932. He became a minister "being graduated from the Anderson College and Theological Seminary in June 1946 at Anderson Indiana. His first charge being in Auburn Indiana."

Children

- i Robert Lee Fiscus-b Mar 14, 1936
- ii Carol "Jean" Fiscus-b Oct 21, 1938
- iii Cheryl Joy Fiscus-b June 19, 1950

1,140-HAROLD CALLEN/ James H/ Thomas J/ James/ Hugh Sr/ Patrick Callen

(33I)HAROLD CALLEN was born (29)March 1900?, the son of James H and Laura (Betz) Callen. His 1st wife was GLADYS STOPP. After her death he married HELEN STOLTZ. Harold died in 1959.

Children of Gladys

1,214 i Dorothy Callen-b Dec 17, 1922
1,215 ii Don Callen-
iii Dean Callen- deceased

Children of Helen

1,216 iv Marjorie Callen-
1,217 v James Callen

1,141-JAY CALLEN/ James H/ Thomas J/ James/ Hugh Sr/ Patrick Callen

(33I)JAY CALLEN was born February 9, 1902, he is the son of James H and Laura (Betz) Callen. (36B)He lived in Clarion, Pa and he sold shoes. Jay married ELVA PETERSON who was born May 29, 1898. Jay died July 3, 1966.

Children

1,218 i Betty Callen-b Jan 9, 1924
1,219 ii Robert Callen-b Dec 24, 1926
iii Thomas Callen-b Sept 2, 1931

1,142-KENNETH CALLEN/ James H/ Thomas J/ James/ Hugh Sr/ Patrick Callen

(33I)KENNETH CALLEN was born August 24, 1913, the son of James H and Laura (Betz) Callen. He married LOUISE ESTHER MURRAY who was born May 23, 1911.

Children

i Phyllis Laura Callen-b Feb 28, 1932 d Sept 3, 1938
1,220 ii Patricia Callen-b June 27, 1936
1,221 iii Harry Kenneth Callen-b Oct 31, 1941

1,143-WILLIAM C CALLEN/ William E/ Thomas J/ James/ Hugh Sr/ Patrick Callen

(33I)WILLIAM C CALLEN was the son of William E and Bessie (Henry) Callen. He married FRANCES (unknown). They lived in Pittsburg.

Only Child

i Sarah Callen-

1,144-HELEN CALLEN/ William E/ Thomas J/ James/ Hugh Sr/ Patrick Callen

(33I)HELEN CALLEN was the daughter of William E and Bessie (Henry) Callen. She married ADOLPH WOODS. (36B)She was a school teacher and taught James R Callen when he was in the first grade at Sligo Grade School.

Children

i Marlene Woods- m JAMES CALHOUN
ii Darl "Corky" Woods- deceased

1,145-DARL H CALLEN/ William E/ Thomas J/ James/ Hugh Sr/ Patrick Callen

(33I)DARL HENRY CALLEN was the son of William E and Bessie (Henry) Callen. He served in WWII. Darl married HELEN HENRY.

Children

i Darl Callen Jr-
ii Michael Callen-
iii Susanne Callen-

1,146-SARAH CALLEN/ William E/ Thomas J/ James/ Hugh Sr/ Patrick Callen

(33I)SARAH CALLEN was the daughter of William E and Bessie (Henry) Callen. She married WILLIAM WIGRIN.

Children

i Millicent Fern Wigrin-
ii James Micketa Wigrin-

1,147-MERLE OVER/ Zula Callen/ Thomas J/ James/ Hugh Sr/ Patrick Callen

(33I)MERLE OVER was the son of Zula (Callen) and John Over. He married PHYLLIS WENTLING.

Children

i Faye Over-
ii Elaine Over
iii Gary Over-
iv Shirley Over-

1,148-CLARA OVER/ Zula Callen/ Thomas J/ James/ Hugh Sr/ Patrick Callen

(33I)CLARA OVER was the daughter of Zula (Callen) and John Over. She married CHARLES EAKER.

Children

i Charles "Johnnie" Eaker-
ii Carla Eaker-
iii Thomas Eaker-
iv Rene Eaker-

1,149-RUTH OVER/ Zula Callen/ Thomas J/ James/ Hugh Sr/ Patrick Callen

(33I)RUTH OVER was the daughter of Zula (Callen) and John Over. She married EDWARD FINEPROCK.

Only Child
1 Harold Finefrock-

1,150-ELMER OVER/ Zula Callen/ Thomas J/ James/ Hugh Sr/ Patrick Callen

(33I)ELMER OVER was the youngest son of Zula (Callen) and John Over. He married ELIZABETH WENTLING.

Only Child
1 Joyce Over-

1,151-DONALD R CALLEN/ Elmo H/ Hugh W/ Samuel/ Hugh Sr/ Patrick Callen

(34B)DONALD RICKARD CALLEN was born January 8, 1908, in Hyde Park, Westmoreland Co, Pa. He married ETHEL MAY RUMBAUGH, who was born September 30, 1904, the daughter of Emma M and William Lee Rumbaugh. Donald died August 18, 1967.

Children
1,222 1 Donald Rickard Callen Jr-b Feb 19, 1929
11 Shirley Ruth Callen-b Dec 22, 1934 m Mr. YOUNG

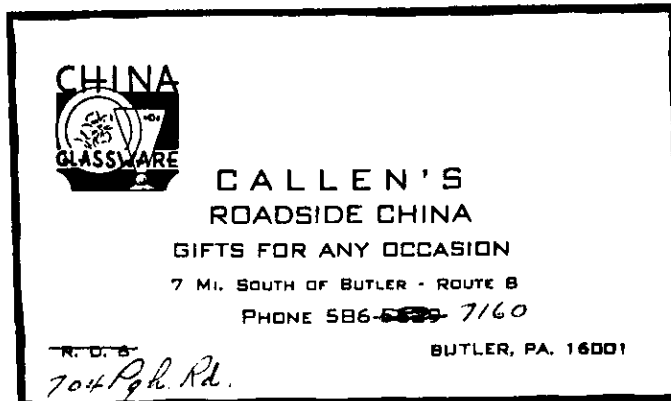

Donald & Ethel's business card

1,152-CHARLES F CALLEN/ Elmo H/ Hugh W/ Samuel/ Hugh Sr/ Patrick Callen

(34C)CHARLES FREEMAN CALLEN was born July 23, 1917 in Hydepark, Westmoreland Co, Pa. He was the son of Hugh Elmo (Elmo Hugh) and Nellie Grace (Cline). He married FLORENCE MAE BRISLIN, who was born on July 4, 1917. Charles died in 1975, Florence died in 1976; both are buried in Memorial Park Cemetery, Butler, Pa.

1,153-HARRY E CALLEN JR/ Harry E / Hugh W/ Samuel/ Hugh Sr/ Patrick Callen

(34A)HARRY EARL CALLEN, JR was born around 1920, the son of Harry E and Sadie (Fennell) Callen. He was a dentist, his office was in downtown Butler, Butler Co, Pa. He married GERMAIN ROARK, whom he met in Jeffersonville, Indiana, originally from Corbin, Kentucky.

"...I lived in Chicago for some 18 years where I trained at the Alexian Brothers Hospital, and was eventually floor supervisor and then into the service, back to Chicago and graduated from Northwestern University. I came back to the University of Pittsburgh where I got my doctors degree. I have a small farm -- we are building a house - raise registered Irish Dexter cattle, and have some registered Saddlebred horses and many other animals and have enough livestock to stock a 100 acre farm. I know more about the pedigrees of my horses and cattle than I do about myself..."

Children

4 sons and an adopted daughter

1,154-HAZEL I CALLEN/ Frederick A/ John H/ Watson/ Hugh Sr/
Patrick Callen

(35A)HAZEL IRENE CALLEN was born March 25, 1892 in DuBois, Clearfield Co, Pa; the daughter of Frederick A and Annie E (Dodson) Callen. Hazel married MILTON MONROE ALBRIGHT who was born November 1, 1884 or 1886 "(the pet coon ate the date book)", in Auburn, Placer Co, California.

Hazel died September 26, 1982. "She died of heart failure (aged 90), lucid as ever she was, requested that her remains be cremated and scattered in the High Sierra, which she loved. She now rests on the Eastern Slope of Slide Mountain, overlooking Nevada's Washoe Valley, site of her first home in the west.."

Hazel loved to write poetry and her family has had her poems bound into a book called the "Silver Lichen". Milton died February 21, 1963 in Auburn Ca.

Children

1,223 i Winifred Claire Albright-b May 10, 1916

1,155-JOHN L CALLEN SR/ Frederick A/ John H/ Watson/ Hugh Sr/
Patrick Callen

(35N)JOHN LEONARD CALLEN SR was born December 25, 1903 in Scotts Mill, Oregon. On May 25, 1930 he married FERN LEAH HICKS, she was born January 5, 1912 in Republic, Washington. John is a retired small businessman, and owner of a tree farm, Fern was a leader of a 4H group, and taught sewing and cooking. They currently live in Idaho. Fern has been stricken with alzthimers disease.

Only Child

1,224 i John Leonard Callen, Jr-b June 7, 1931

1,156-LUCILL M CALLEN/ George W/ John H/ Watson/ Hugh Sr/ Patrick
Callen

(35B)LUCILL MARIE CALLEN married MAURICE ISAAC ALLEN. They live in Oklahoma City.

Children

- 1,225 i Peggy Allen-b Nov 28, 1941
ii George Michael Allen-b May 8, 1943
iii Kathy Jean Allen-b Nov 6, 1947 m Mr. REECE

1,157-WILLIAM C CALLEN/ Charles B/ Alvin C/ Watson/ Hugh Sr/
Patrick Callen

(35F)WILLIAM CHARLES CALLEN was the son of Charles B and Mary
Sophia (Rose) Callen. By occupation he was a restaurant owner. He
married MAURINE ELIZABETH BEAR of Ohio who was a secretary. William
was a major in the U.S. Army and served at Okinawa.

Children

- i Chris Doyle Callen-b Sep 9, 1951
ii Lindy Ann Callen-b Jun 20, 1954
1,226 iii Craig Charles Callen-b Jun 27, 1956

1,158-ROBERT C CALLEN/ Charles B/ Alvin C/ Watson/ Hugh Sr/
Patrick Callen

(35F)ROBERT C CALLEN was born on June 11, 1919, in McKeesport, Pa.
By occupation he was a carpenter. He married CHARLOTTE MARIE VAN
ARSDALE, who was born November 12, 1919 in New Brighton, Pa.
Charlotte was a housewife. Robert died December 12, 1974, and
Charlotte died in November 1979, both are buried in Palmyra, Ohio

Children

- 1,227 i Barry Lee Callen-b July 10, 1941
ii Bonnie Lou Callen- b Jan 24, 1943

1,159-VIOLET CALLEN/ Charles B/ Alvin C/ Watson/ Hugh Sr/ Patrick
Callen

(35B)VIOLET CALLEN is the daughter of Charles B and Mary (Rose)
Callen. Violet is one of the first female Methodist ministers, she
is living in Pittsburg, Pa. She married MR. TURNER.

1,160-VELMA A CALLEN/ Samuel W/ Alvin C/ Watson/ Hugh Sr/ Patrick
Callen

(35C)VELMA ALVERDA CALLEN was born December 13, 1911 in Pittsburg,
Allegheny Co, Pa. She was a church pianist at age 12. On April 14,
1934 she married MARTIN DILLAR ALLISON, in Kansas City, Kansas. She
then married CARL HEROD. Velma has contributed to the research and
information in this book. She is still active in her community in
Gladstone, Mo, working with the elderly.

1,161-SAMUEL W CALLEN/ Samuel W/ Alvin C/ Watson/ Hugh Sr/ Patrick
Callen

(35I)SAMUEL WATSON CALLEN JR was born August 26, 1918, in
Pittsburgh, Pa. "My Mother & Father moved here to Missouri in 1923.
I attended schools in and around Kansas City, Mo."

Samuel married HENRIETTA PALMER on June 24, 1945 in Liberal, Mo. They had no children. They are retired and living in Springfield, Missouri.

1,162-ALVIN C CALLEN/ Samuel W/ Alvin C/ Watson/ Hugh Sr/ Patrick Callen

(35C-35H)ALVIN CUMMINGS CALLEN III was born December 7, 1924, in Maple Park, Clay Co, Mo (now Kansas City). He married DORIS JEWELL on June 19, 1944 in Clinton, Iowa, they were divorced. Alvin then married LIBBY (unknown). His military records show he was 5'4", 133 lbs, brown hair, and blue eyes.

(35C)Alvin enlisted in the U.S. Army in January of 1943 and served two years 9 months. He served at Rhineland, Central Europe. He received an honorable discharge for disability on November 1, 1945. He received the following citations: WWII Victory Ribbon; Eamc Ribbon with 2 Bronze Service Stars; and ATCM.

Alvin died June 22, 1975, and is buried in Fairview Cemetery, Liberty, Clay Co, Mo.

Children of Doris

- 1,228 i Michael Callen-b Mar 3, 1949
ii David Callen-
iii Barbara Callen- m Mr. LATHROP
iv Judy Callen- m Mr. OTTO

obituary of ALVIN C CALLEN II
(newspaper unknown)

Alvin C Callen II, 48, of...[Kansas City] passed away June 20, at Menorah Hospital. He lived in the Maple Park Area in Clay County most of his life.

He leaves his wife, Libby Callen, of the home; two sons, Michael Callen, Raytown, David Callen; two daughters, Barbara Lathrop, and Judy Otto, both of Clinton, Iowa; and six grandchildren. He leaves a brother, Samuel Callen Jr., Shawnee Kansas, and three sisters, Velma Herod, Maple Park; Florence Charlton, K.C. Mo; and Juanita Ray, Liberty.

Funeral services were held Monday, June 24, at the Church Archer Funeral Home and burial was in Fairview Cemetery, Liberty.

1,163-HARRY C CALLEN/ Clyde B/ Alvin C/ Watson/ Hugh Sr/ Patrick Callen

(35C)HARRY CLYDE CALLEN was the son of Clyde and Grace (Flynn) Callen. He married GLADYS EARLE.

Children

- i Clyde Callen-
ii Gayle Callen-

1,164-FRED C CALLEN/ Philo L/ Alvin C/ Watson/ Hugh Sr/ Patrick Callen

(35N)FREDERICK CHARLES CALLEN was born January 17, 1916 in Chicago, Illinois, the son of Philo L and Josephine (Brohamer) Callen. On January 1, 1937 in Caledonia, Ill he married MARJORIE DARLENE GOULD. Marjorie was born April 20, 1919 in Caledonia, Ill. They are both retired and living in Washington.

Children

1 John "Garry" Callen-b Aug 10, 1938
1,229 ii Victor Alan Callen-b Oct 8, 1940

1,165-CRAIG R CALLEN/ Philo L/ Alvin C/ Watson/ Hugh Sr/ Patrick Callen

(35J)CRAIG R CALLEN is the son of Philo L and Josephine (Brohamer) Callen. He married MARY MADIGAN, they have 2 daughters and three sons.

Children

i Sindy Callen-
ii Kamla Callen-
iii Brad Callen-
iv Conon Callen-
v Corbin Callen-

1,166-MARSHALL K CALLEN/ Philo L/ Alvin C/ Watson/ Hugh Sr/ Patrick Callen

(35J)MARSHALL K CALLEN was born October 30, 1930 in Rockford, Illinois. He is the son of Philo and Josephine (Brohamer) Callen. On January 11, 1952 Marshall married MARILYN L MOSHIER in Seattle, Washington. Marilyn was born December 15, 1932. Marshall is a claims manager, Marilyn is a housewife. They live in Edmonds, Washington.

Children

i Kent M Callen-b Sept 19, 1953
ii Kris M Callen-b June 16, 1955

1,167-JOHN F BIRD/ Clyde C/ Sarah A Callen/ Watson/ Hugh Sr/ Patrick Callen

(35L)"JOHN FRANCIS BIRD, the son of Clyde and Eva (Rosencrance) Bird, was born April 17, 1914 in Evenwood, Randolph Co., West Virginia. During the year 1917, the family moved to Erie, Erie Co., Pa where his father Clyde was employed by the General Electric Co. A new town, later named Lawrence Park, a suburb of Erie, was being built to house the new employees streaming in to the new General Electric Plant.

"John grew up in this fascinating turmoil of new construction; new houses, general stores, churches, a community center, municipal buildings, dirt roads and sidewalks. Here he was educated through

high school.

"During his teenage years, he caddied at the local golf course and later worked Shorewood on Lake Erie, a fishing resort, where he took care of the rental fishing boats. At age 14, his father Clyde, was killed fighting a fire and two years later his mother Eva died of kidney failure, leaving three young children orphaned.

John married on Jan 22, 1932 to MABEL E REYNOLDS, his high school sweetheart, the daughter of William H and Maude (Dool) Reynolds.

"John took several accounting courses and after a number of jobs (these were the depression years) he was hired as a bookkeeper at the Erie Printing Co. in Erie, Pa. John served in the Navy during World War II and after his discharge he resigned his position at the Erie Printing Co. He enrolled in the printing school at Carnegie Tech under the G.I. bill. He then obtained a position with a large printing firm, The W.H. Kistler Stationary and Printing Co. in Denver, Colorado as Production Manger.

"After thirty years with the same company, John retired in 1976 and moved with his wife to a small fishing village on Mustang Island called Port Aransas, Texas. Here they enjoy the fishing and the Gulf of Mexico.

Children

- i John William Clyde Bird-b Nov 10, 1932
m EVELYN J STUTZMAN on Nov 5, 1954
- ii Caroline Beryl Bird-b Apr 14, 1934
m DONALD A COLLINS on Aug 1, 1954
- iii Muriel Rae Bird-b May 30, 1935
m RANDON E HOLBEN on June 19, 1954
- iv Victor Reynolds Bird-b May 16, 1940
m CONSTANCE D BROWN on May 16, 1964

1,168-ADELAIDE CRYTZER/ Ida Steele/ Sarah Rayburn/ Matthew/ Nellie Callen/ Patrick Callen

(32)ADALAIDE ROSELAND CRYTZER was born September 6, 1914, the daughter of Ida (Steele) and Harry W Crytzer. She married RAYMOND LIVENGOOD. Adelaide died on February 2, 1965.

Children

- 1,230 i John Livengood-b July 17, 1944
- 1,231 ii Mary Beth Livengood-
- 1,232 iii Ellen Sue Livengood-

1,169-FRANKLIN L CALLEN/ Leigh B/ David D C/ James F/ David/ Patrick Callen

(37F)FRANKLIN LEIGH CALLEN was born February 2, 1907 in Madison, Kansas. In February of 1935 in Madison, Ks. he married ESTHER IRENE BROTHERS who was born June 5, 1914 in Soldier, Ks. Esther is a retired nursing assistant; Franklin was a janitor. Franklin died February 19, 1985 and is buried in Blakely Cemetery, Madison, Kansas.

Children

- 1,233 i Wilma May Callen-b Apr 18, 1937
ii James Leigh Callen-b Sept 2, 1943
iii Wayne Franklin Callen-b Aug 26, 1946
iv Doris Irene Callen-b Apr 1, 1951 m Mr. MACKEY

1,170-JULIA N CALLEN/ George/ Elliott N/ William/ David/ Patrick Callen

(37E)JULIA NANCY CALLEN was born August 21, 1918, the daughter of George and Florence (Vogel) Callen. Julia married JAMES MATHER on March 29, 1942.

Only Child

- i Gary Mather-b Aug 19, 1943

1,171-GEORGIA J CALLEN/ George/ Elliott N/ William/ David/ Patrick Callen

(37E)GEORGIA JANE CALLEN was born July 21, 1921. She married ROBERT DAWSON in January 1953.

1,172-JOHN E CALLEN/ George/ Elliott N/ William/ David/ Patrick Callen

(37E)JOHN ELLIOTT CALLEN was born December 4, 1925 in St Louis Missouri; he is the son of George and Florence B (Vogel) Callen. On April 26, 1952 he married MARY MARGARET WIDEL. Margaret was born July 24, 1930 in St Louis. John is a retired foreman for the Tret-O-Lite Chemical Corporation.

Children

- i Diane Marie Callen-b April 4, 1953
ii Steven Michael Callen-b Oct 20, 1954
iii Lisa Kay Callen-b May 22, 1961
iv Karen Ann Callen-b April 16, 1965
v Kathy Lynn Callen-b Sept 10, 1969

1,173-ALFRED ANDERSON/ Ida A Belding/ Mary L Callen/ William/ David/ Patrick Callen

(37E)ALFRED ANDERSON was born December 22, 1902, the son of Ida (Belding) and John Anderson. In 1921 he married GLADYS KELLOGG - they were divorced in May 1939. "Alfred Anderson was married again but I do not know wife's name."

Children

- i Richard Anderson-b Mar 192_
ii Edward Anderson-
iii Charles Anderson-

1,174-CHARLES R FLEMING/ Augusta A Belding/ Mary L Callen/
William/ David/ Patrick Callen

(37E)CHARLES RYKER FLEMING was born December 19, 1905, the son of
Augusta (Belding) and Willis Fleming. He married KATHRYN
(Unknown). Kathryn died in March of 1944.

Only child

i Robert Fleming-b Sept 1941

1,175-RUSSEL FLEMING/ Augusta A Belding/ Mary L Callen/ William/
David/ Patrick Callen

(37E)RUSSEL FLEMING was born September 3, 1909, the son of Augusta
(Belding) and Willis Fleming. He married JANET ROBERTS.

Children

i Linda Fleming-
ii boy-

1,176-GUELDA JOHNSON/ Hattie B Callen/ Alva B/ Arthur F/ David/
Patrick Callen

(37A-37B)GUELDA JOHNSON was born July 13, 1911, the daughter of
Hattie B (Callen) and Bert Johnson. She married JOHN GEORGE.

Children

i Johnna Berthelle George-b July 12, 1936
ii Tommy John Blake George-b Oct 7, 1937
iii Jenece "Jenny" Lynn George-b Aug 23, 1947

1,177-DONALD D CALLEN/ Edward E/ David D/ Arthur F/ David/ Patrick
Callen

(37A)DONALD DEWITT CALLEN was born June 2, 1916 in Isabel Kansas;
the son of Edward E and Eunice (Dolbow) Callen. On December 2, 1939
in Wichita, Kansas Donald married BONNIE JEAN WALTON. Bonnie was
born August 7, 1920. "Don lives somewhere in Washington now - he
worked for Bowing Air Lines."

Children

i James Donald Callen-b Jan 31, 1941
ii Patricia Jean Callen-b May 24, 1945

1,178-TONY V CALLEN/ Edward E/ David D/ Arthur F/ David/ Patrick
Callen

(37O)TONY VERN CALLEN was born October 27, 1918, the son of Edward
E and Eunice (Dolbow) Callen. On March 24, 1940 in Wichita, Kansas
he married IRENE INEZ BRONSON. Irene was born October 20, 1918.

Children

- i Thomas Eugene Callen-b Mar 31, 1947 m CARON TEACHMAN
- ii Jon Michael Callen-b Oct 19, 1951 m KELLY EDMISTON
- iii Barbara Ann Callen-b
- iv Tony Vern Callen Jr-b m BRENDA

1,179-VERNON I CALLEN/ Otto O/ David D/ Arthur F/ David/ Patrick Callen

(37A)VERNON IRVING CALLEN was born October 29, 1916 in Murdo, South Dakota; the son of Otto O and Cora (Wendt) Callen. On April 9, 1939 he married VIRGINIA MAUDE WILLIAMS who was born June 23, 1918 in Murdo, SD. Vernon died November 3, 1955 in Vallejo, Ca.

Only Child

i Douglas Eugene Callen-b Aug 16, 1943 d Dec 11, 1986

obituary of VERNON I CALLEN
(Rapid City, S Dakota newspaper)

Vernon I. Callen, 39 year old former Black Hills resident, died of a heart attack Wednesday afternoon in his office in Vallejo, Calif.

A superintendent with the California Allied Company, he was interviewing two ladies for employment at the time. Funeral services are pending.

Callen was born in Murdo where he also received his high school education. He grew up in Murdo, Mitchell and Rapid City. He was married to Virginia Williams some 12 years ago, and moved to California 11 years ago.

Survivors include his widow and an 11-year old son, Douglas, north of Vallejo; his father O.O. Callen, Rapid City; and two sisters, Mrs. Joe Marlovits, Riverside, California and Mrs. Bess Leal, Warm Springs, California; and a brother, Lloyd Callen, Vallejo, California.

Callen's father left Rapid City by plane Thursday for Vallejo to make funeral arrangements.

It would appear that he died on Nov. 3, 1955.

1,180-GWENLEEN M CALLEN/ Otto O/ David D/ Arthur F/ David/ Patrick Callen

(37A)GWENLEEN CALLEN was born September 28, 1918 in Murdo, S Dakota, she was the daughter of Otto O and Cora (Wendt) Callen. She married JOSEPH MARLOVITS, who was born October 3, 1922 in Pennsylvania.

Only Child

1,234 i Judith Elaine Marlovits-b Aug 24, 1946

1,181-LLOYD L CALLEN/ Otto O/ David D/ Arthur F/ David/ Patrick Callen

(37A)LLOYD LONNIE CALLEN was born December 14, 1921 in Murdo, S Dakota, the son of Otto and Cora (Wendt) Callen. On November 18, 1949 in Los Vegas, Nevada he married HAZEL JOANN KINNEY, who was born May 4, 1930.

Children

- 1,235 i Gary Glenn Callen-b Oct 12, 1950
- ii Richard Roy Callen-b Jan 15, 1952 unmarried
- 1,236 iii Kevin Kinney Callen-b Mar 4, 1956
- iv Candance Corine Callen-b Oct 12, 1960
- m MICHAEL DALEEP May 1, 1982 divorced

1,182-BESSIE B CALLEN/ Otto O/ David D/ Arthur F/ David/ Patrick Callen

(37A)BESSIE BELLE CALLEN was born December 3, 1925, she is the daughter of Otto O and Cora (Wendt) Callen. On August 2, 1945, in Roswell, New Mexico, Bessie married MELVIN CHARLES LEAL. Melvin was born in Warm Springs, California on November 26, 1924. There are no children of this marriage. Bessie is interested in her family history and has contributed to information in this book.

1,183-KATHLEEN P CALLEN/ Cleo P/ David D/ Arthur F/ David/ Patrick Callen

(37A)KATHLEEN PHYLLIS CALLEN was born August 21, 1918 in Kingman, Kansas. On August 10, 1940 she married CHESTER LOUIS TODD who was born March 16, 1921. They now live in San Antonio, Texas.

Children

- i Jennene Kay Todd-b May 11, 1941 Wichita, Kansas
- ii Debra Lynn Todd-b Nov 5, 1953 Hutchison, Kansas

1,184-DELBERT R CALLEN/ Cleo P/ David D/ Arthur F/ David/ Patrick Callen

(37D)DELBERT RENE "BOB" CALLEN was born August 9, 1920 in Hutchison, Kansas. On February 22, 1941, in Newton, Kansas, he married KATHLEEN WILMA FORD who was born June 5, 1922 in Copan, Oklahoma. Bob is retired from the Southwestern Bell Telephone Co. They live in Fort Scott, Kansas, he has contributed to this book

Children

- i Danny Bob Callen-Aug 22, 1942 Wichita, Ka
- ii Diana Kay Callen-b July 31, 1947 Wichita, Ka
- iii Susan Rene Callen-b Nov 18, 1955 Garden City, Ka

1,185-LONNIE E CALLEN/ Cleo P/ David D/ Arthur F/ David/ Patrick Callen

(37D)LONNIE EDWARD CALLEN was born March 31, 1929 in Kingman, Kansas, the son of Cleo P and Josephine (Mease) Callen. On October 12, 1955 in Denver, Colorado he married BARBARA JEAN SALLEE

who was born September 13, 1935 in Denver. They live in Boulder, CO.

Children

- i Lon Edward Callen-b Apr 28, 1956 Denver Col
- ii Lynette Jean Callen-b Oct 19, 1968 Damp Spring, Md

1,186-BETH M CALLEN/ Harold V/ David D/ Arthur F/ David/ Patrick Callen

(37D)BETH MARGENE CALLEN was born December 7, 1928 in Nashville, Kansas. On April 22, 1951 in Hutchison, Ka she married DONALD DEAN MILLIKAN.

Only Child

- i Michael Nevin Millikan-b Aug 17, 1952 Hutchison, Ka

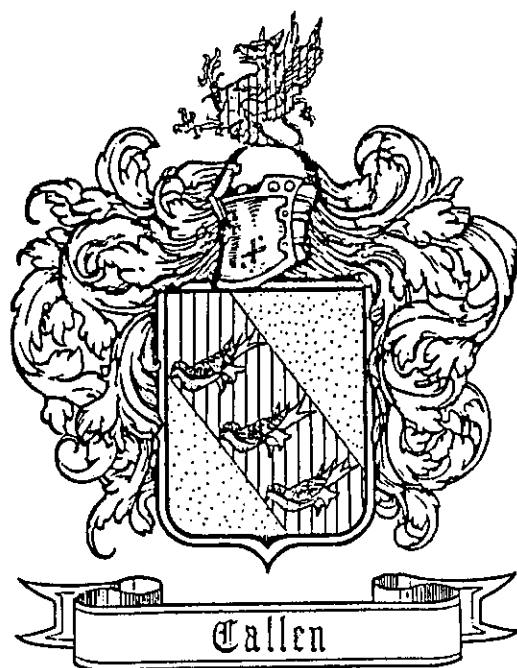

LINE OF PATRICK CALLEN - 7TH GENERATION

1,187-CECELIA L CALLEN/ Perle/ Alpheus/ Hugh/ Thomas/ Hugh Sr/
Patrick Callen

(33I)"CECELIA LEANNA CALLEN, born November 5, 1902, Imperial, Allegheny County, Pa. She married JAMES BRYANT (marriage date unknown) and was granted a divorce, March 3, 1924 which became final 6 months thereafter. She married ERVIN LEE SIMMONS, January 2, 1925 in Drumright, Creek County, Oklahoma... Cecelia passed away July 21, 1973 in San Bernardino, Calif..."

Children

1,237 i Dwane Perle Simmons-b Aug 16, 1927
1,238 ii Dwight William Simmons-b Aug 12, 1928

1,188-WILLIAM A CALLEN/ Perle/ Alpheus/ Hugh/ Thomas/ Hugh Sr/
Patrick Callen

(33I)WILLIAM ALPHEUS CALLEN was born July 27, 1908 in Sigel, Jefferson Co, Pa. In Corsica, Pa he married CATHERINE ELIZABETH KERR who was born in Corsica, Pa on June, 30, 1915. William was a barber, Catherine was a factory worker. "My Mother, Catherine still resides in Corsica during the summer and spends the winters with either my sister in Florida or with us (1990)."

William died in Sigel, Pa on March 12, 1982.

Children

1,239 i William Arthur Callen-b Sept 18, 1935
1,240 ii Mary Catherine Callen-b Jan 15, 1937
1,241 iii Barbara Lea Callen-b May 12, 1938
1,242 iv Jack Lawrence Callen-b Aug 4, 1940

1,189-PAUL V STAHLMAN/ Edward R/ Blanch Callen/ Hugh/ Thomas/ Hugh Sr/
Patrick Callen

(33H)PAUL VANCE STAHLMAN was born June 14, 1919 in Irwin, Pa., he is the son of Edward R and Margaret E (Davidson) Stahlman. On September 15, 1951 at Sault Ste. Marie, MI he married ELIZABETH M PARTRIDGE. Elizabeth was born November 2, 1926 in Manchester, New Hampshire.

Paul is retired from the US Air Force. He enjoys family research and has contributed information in this book.

Children

i Richard Lee Stahlman-b Mar 9, 1954
ii Martha Jean Stahlman-b Sept 12, 1955
iii Margaret Ellen Stahlman-b Feb 7, 1958
iv Edward John Stahlman-b July 30, 1963

1,190-ARTHUR B CALLEN/ Burl A/ William T/ John/ Thomas/ Hugh Sr/
Patrick Callen

(33G)ARTHUR BURL CALLEN was born on January 19, 1930 in Charleston, W.Va., the son of Burl A and Stashie (Tackett) Callen.

His occupation is Teletype, and Data Repair for the C&P Telephone Co, in Clendenin W.Va.

Arthur married BETTY LOU SAMPLES, who was born November 28, 1930, the daughter of Benjamin and Mary Florence (Radar) Samples. Betty died July 24, 1978, and is buried in Big Chimney, W.VA. Arthur is living in W.Va.

Children

- 1,243 i Jeffrey Arthur Callen-b Nov 15, 1954
 ii Susan Lynn Callen-b July 19, 1957 m Mr HALL
 iii Patty Ann Callen-b Jan 31, 1959 m Mr WYGAL

1,191-"BETTY" CALLEN/ John W/ James A/ John/ Thomas/ Hugh Sr/
Patrick Callen

(33F)"BETTY" MARY ELIZABETH CALLEN was born June 14, 1924, the daughter of John and Mabelle (Lawther) Callen. She is a Licensed Practical Nurse. She married SAMUEL ANDERSON GILLIGAN, who was born January 23, 1920.

Children

- i Mary Alice Gilligan-b May 19, 1949 m Mr MOSES
ii Kathleen Gilligan- b Feb 2, 1954 m Mr GALATI
Kathleen is a teacher.

1,192-JOSEPHINE L CALLEN/ John W/ James A/ John/ Thomas/ Hugh Sr/
Patrick Callen

(33F)"JO" JOSEPHINE LEE CALLEN was born August 24, 1926, in Vandergrift, Pa, the daughter of John W and Mabelle (Lawther) Callen. Her occupation is in electronics. She married 1st on October 10, 1944 to CURTIS H BAKER. She married 2nd to STANLEY GRABASZ, born October 28, 1914 in Newark, New Jersey, he is a baker.

Children

- i Danny Lee Baker-b Sep 3, 1945
ii Dianna Lynn Baker-b Nov 20, 1947

1,193-LLOYD T CALLEN/ Charles J/ James A/ John/ Thomas/ Hugh Sr/
Patrick Callen

(33C)LLOYD TRUDELL CALLEN was born in Hyde Park, Westmoreland Co, Pa on February 9, 1920. He is the son of Charles J and Hulda (Thompson) Callen. Lloyd was named after Mr. Lloyd and Mr. Trudell who were friends of his father while stationed in France during WWI.

When Lloyd was 18 his mother died. He had to quit school temporarily to help out his family. He returned to school and graduated from Concord Consolidated High School in 1940.

On June 19, 1942 he married OLIVE LOUISE GIBSON (his high school sweetheart) who was born September 10, 1921, the daughter of A Roy and Grace (Emery) Gibson. Olive is a seamstress and mother. She is "the steadying factor in my life... a marvelous woman who deserves tremendous credit and praise."

Lloyd graduated from Practical Bible Institute in NY in 1944, and is an ordained Baptist minister. He became associated with the Church of God, and under this church organization he was transferred to a new church about every three years, all in Ohio. He was transferred from Belle Center to Convoy (near Van Wert), then to McComb, (near Findley), then to Comet (near Akron).

In 1958 he began substitute teaching for the Akron Christian Grade School, and afterward taught in many Christian schools in many states: South Carolina, North Carolina, Florida, and back to Ohio.

Beside being an ordained minister and teacher, Lloyd is an artist, working with oil paints, chalk, and woodburning. Also to help supplement his income to help feed their 11 children, he writes and has worked as a night watchman, plus numerous other jobs. "Enjoy fishing, reading, writing, and gardening."

Lloyd has received a Master of Biblical Theology, and is currently Head of Academic Affairs at Freedlandia College in Cassville, Mo.

Children

- 1,244 i Harvey Gordon Callen-b Aug 14, 1943
- 1,245 ii John Jay Callen-b Nov 4, 1944
- 1,246 iii Louis Trudell Callen-b Nov 13, 1945
- 1,247 iv Edna Marie Callen-b Sept 11, 1947
- 1,248 v Beatrice Linda Callen-b Dec 1, 1950
- 1,249 vi Dorothy Grace Callen-b Aug 11, 1952
- 1,250 vii William George Callen-b Apr 9, 1954
- 1,251 viii Darlene Bertha Callen-b Aug 28, 1956
- 1,252 ix Larry Eugene Callen-b Aug 14, 1959
- 1,253 x Daniel Roy Callen-b Oct 9, 1962
- 1,255 xi Ruth Elaine Callen-b Feb 25, 1963



Back Row: JOHN, LOU, RUTH, HARV Middle Row: BEA, DOROTHY,
 LLOYD, OLIVE, BILL, EDNA Bottom Row: LARRY, DANNY, DARLENE

1,194-THOMPSON L CALLEN/ Charles J/ James A/ John/ Thomas/ Hugh Sr/ Patrick Callen

(33C)THOMPSON LEMOYNE CALLEN was born September 30 1921, the son of Charles J and Hulda (Thompson) Callen. He married PAULINE JORDAN. He was a soldier during WWII. He is involved in Church music ministry in LaPort, Indiana.

Children

1,255 i Carol Ann Callen-b Dec 12, 1944
ii Lois Jean Callen-b Aug 22, 1949
1,256 iii James Duane Callen-b Dec 24, 1952
1,257 iv Cheri Lynn Callen-b Jan 24, 1958

1,195-HAROLD E CALLEN/ Charles J/ James A/ John/ Thomas/ Hugh Sr/ Patrick Callen

(33C)HAROLD EDWARD CALLEN was born July 23, 1924 in Pennsylvania, the son of Charles J and Hulda (Thompson) Callen. He married "SIS" ANNA MARIE KILEY. Harold was a soldier in WWII. He died on August 21, 1951 in Butler Co, Pa, of Hodgkins disease.

Children

1,258 i Kenneth Lee Callen-b Nov 26, 1948
1,259 ii Charles Josiah Callen-b Feb 15, 1951

1,196-WALTER E CALLEN/ Charles J/ James A/ John/ Thomas/ Hugh Sr/ Patrick Callen

(33C)WALTER EARL CALLEN was born February 15, 1929 in Pennsylvania, the son of Charles J and Hulda (Thompson) Callen. His mother was buried on Walter's 9th birthday. Walter married "DOT" DOROTHY HELEN MACKEY, who was born May 12, 1929. Because of Dot's health (arthritis) they moved to Harlingen, Texas. They are both very active in their church.

Children

1,260 i Howard Wayne Callen-b Dec 18, 1950
1,261 ii Dale Walter Callen-b Mar 6, 1953

1,197-DOROTHY M CALLEN/ Thomas W/ James A/ Joh/ Thomas/ Hugh Sr/ Patrick Callen

(33E)DOROTHY MAE CALLEN was born March 11, 1922 in Emlenton, Pennsylvania, the daughter of Thomas Wayne and Goldie (Hepler) Callen. On February 24, 1943, in Vandergrift, Pa she married VERYL BRYAN TOWNSEND who was born February 22, 1919 in Pennsylvania. Veryl was an auto mechanic. Dorothy was a scout leader for 30 years and did house work.

Veryl died July 14, 1983 from flu and a heart attack; Dorothy died December 18, 1986 in New Kensington, Pa. They are buried in the Greenwood Memorial Park, in Lower Burrell, Pa.

Children

- i Patricia Elaine Townsend-b Jun 29, 1943
m Mr. WOODRAW
- ii Veryl Bryan Townsend, Jr-b Oct 7, 1944
- iii Leslie Wayne Townsend-b Oct 14, 1945
- iv Colleen Eunice Townsend-b May 26, 1948
m Mr. CALDWELL
- v Sandra Kay Townsend-b Jun 21, 1952 m Mr. GREGG
- vi Cindy Noreen Townsend-b Apr 26, 1958 m Mr. SMITH

1,198-PAUL E CALLEN/ Thomas W/ James A/ John/ Thomas/ Hugh Sr/
Patrick Callen

(33D)PAUL ELLSWORTH CALLEN was born February 20, 1924, in Emlenton, Pa. By occupation he was a machinist. He attended high school at Apollo, Pa. and college at Anderson, Indiana. On December 18, 1945 he married MARJORIE CAMILLE BENNETT who was born April 26, 1928 in Hyde Park, Pa. the daughter of Alfred H and Elsie Marie (Myers) Bennett.



DEBORAH, TIMOTHY, LARRY, LINDA
PAUL & MARJORIE

Paul served with the 71st Navy CB's during World War II. He served in the South Pacific attached to the 6th division of marines. Paul currently is retired and resides in Leechburg, Pa - but they spend their winters in Florida.

Children

- 1,262 i Linda Diane Callen-b Dec 27, 1946
- 1,263 ii Jerry Paul Callen-b Feb 3, 1950
- 1,264 iii Deborah Suzanne Callen-b Dec 3, 1951
- 1,265 iv Timothy Mark Callen-b Nov 8, 1954
- 1,266 v Larry Wayne Callen-b Oct 1, 1956

1,199-"TILLIE" CALLEN/ Thomas W/ James A/ John/ Thomas/ Hugh Sr/
Patrick Callen

(33E)MATILDA ELIZABETH CALLEN, called "TILLIE" was born October 13, 1930 in Vandergrift, Pa. On February 7, 1948 Tillie married ROBERT EUGENE NALE, who was born July 26, 1926 in Apollo, Pa. Tillie is a seamstress; Robert worked in a brickyard.

Robert died March 9, 1980. Tillie is living in North Apollo, Pa.

Children

- 1,267 i Lana Yvonne Nale-b Dec 10, 1948
- ii David Lynn Nale-b Apr 19, 1953 Indiana, Pa

1,200-DELLA Y CALLEN/ Thomas W/ James A/ John/ Thomas/ Hugh Sr/
Patrick Callen

(33E)DELLA YVONNE CALLEN was born June 15, 1933 in Vandergrift,
Pennsylvania. She is the daughter of T Wayne and Goldie (Hepler)
Callen. On May 18, 1956 in Emlenton, Pa Della married CHARLES
RICHARD BERLIN who was born in Medina, Ohio on April 8, 1932.
Charles is a chemical worker and Della is a housewife and mother.

Only Child

1,268 i Tina Hope Berlin-b May 15, 1960

1,201-ROBERTA L CALLEN/ Howard M/ Charles H/ John/ Thomas/ Hugh
Sr/ Patrick Callen

(33B)ROBERTA LOUISE CALLEN was born July 30, 1931. She is the
daughter of Howard M and Eleanor Callen. Roberta married 1st to Mr.
LaBORDE, they are divorced. Roberta married again.

Children

i Linda-
ii Lorrie
iii Ellen

1,202-CHARLES BUCCIGROSSI/ Hazel Callen/ Charles H/ John/ Thomas/
Hugh Sr/ Patrick

(33B)CHARLES DAVID BUCCIGROSSI was born January 26, 1944. He was
first married to LORA ST. JOHN, they are divorced. He married
second to RITA (unknown). Charles lives in New Mexico and is a
radio announcer.

Children

i Bonnie Jean Buccigrossi-b Mar 6, 1970
ii Enrico Charles Buccigrossi-b Sept 2, 1972
iii Robert Christopher Buccigrossi-b Oct 2, 1973
iv Jason Alexander Buccigrossi-b June 5, 1975

1,203-FRANK H SILVES/ Blanche Bashline/ Mary E Callen/ Thomas J/
James/ Hugh Sr/ Patrick Callen

(36A)FRANK HUNTER SILVES, called "Hunter", was born December 17,
1915, the son of Blanche (Bashline) and Herman D Silves. He "is a
singer, and does a lot of entertaining. He is a commercial artist,
but now is retired - all but the entertaining. He plays the organ
some, and different kinds of instruments. Including a new one
Omnichord, he plays it in church also." "Hunter married MARTHA JEAN
KEYS, who was born March 7, 1915, she died April 25, 1980, they
had no children." He moved back with his mother and took care of
her.

1,204-MILDRED L CALLEN/ Raymond A/ Hugh S/ Thomas J/ James/ Hugh
Sr/ Patrick Callen

(36B)MILDRED LOUISE CALLEN was born June 30, 1920, she is the
daughter of Raymond and Julia (Lowe) Callen. Mildred married Mr.
CAMPBELL and is currently living in Erie, Pa. They have 5 children.

1,205-JAMES R CALLEN/ Raymond A/ Hugh S/ Thomas J/ James/ Hugh Sr/
Patrick Callen

(36B)JAMES RUSSELL CALLEN was born on February 25, 1923 in Sligo, Penna, "attended school there and at Butler, Pa. entered the army in 1943 and upon discharge in 1946 went to Washington, D.C. to work as a civilian in the Navy Department, Bureau of Aeronautics, retiring in 1980 and presently living in Rockville, Md."

He is the son of Raymond A and Julia M (Lowe) Callen. On July 16, 1949 in Washington D.C. he married BETTY MARIE (BARNARD) PULLIAM who was born on July 15, 1919 in Washington D.C. (Betty's first husband was killed in France in WWII.)

Children

1,269 i Michael Stephen Callen-Sept 12, 1950
1,270 ii Joseph Raymond Callen-b May 21, 1953
1,271 iii Mary Patricia Callen-b Apr 27, 1956
1,272 iv Anne Elizabeth Callen-b May 17, 1957

1,206-ROBERT M CALLEN/ Raymond A/ Hugh S/ Thomas J/ James/ Hugh Sr/
Patrick Callen

(36B)ROBERT MARTIN CALLEN was born on November 14, 1925, he is the son of Raymond A and Julia M (Lowe) Callen. "He married DeMARIS EBERHART (her grandmother lived in Callensburg). Bob and DeMaris went to Ireland 2 years ago for the 'Callen Reunion'... They winter each year at Key Fiesta, The Keys, Florida"

1,207-MARY E SHAW/ Bertha L Callen/ Hugh S/ Thomas J/ James/ Hugh Sr/
Patrick Callen

(33I)MARY ELIZABETH SHAW was born July 24, 1916, she was the daughter of Bertha L (Callen) and James J Shaw. On August 10, 1940 Mary married ROWLAND JONES.

Only Child

i Carol Lee Jones-b Dec 24, 1942

1,208-ROBERT L SHAW/ Bertha L Callen/ Hugh S/ Thomas J/ James/
Hugh Sr/ Patrick Callen

(33I)ROBERT L SHAW was born April 8, 1918, the son of Bertha L (Callen) and James J Shaw. On August 2, 1947 Robert married THELMA DUBLIN.

Children

i James Shaw-b Apr 13, 1950
ii Donald Hugh Shaw-b July 23, 1951
iii Debra Sue Shaw-b Sept 28, 1953

1,209-FRANK C SHAW/ Bertha L Callen/ Hugh S/ Thomas J/ James/ Hugh Sr/
Patrick Callen

(33I)FRANK CALLEN SHAW was born April __, 1920, the son of Bertha L (Callen) and James J Shaw. On September 22, 1948 he married JANE GROOKETT. They had no children

1,210-RICHARD C SHAW/ Bertha L Callen/ Hugh S/ Thomas J/ James/
Hugh Sr/ Patrick Callen

(33I)RICHARD CARL SHAW was born July 22, 1921, the son of Bertha L
(Callen) and James J Shaw. On July 24, 1943 he married JUNIATA
AIRHART. Richard died February 8, 1948.

Only Child

i Richard Shaw II-b Nov 2, 1947 d June 22, 195_

1,211-JOSEPH H SHAW/ Bertha L Callen/ Hugh S/ Thomas J/ James/
Hugh Sr/ Patrick Callen

(33I)JOSEPH HUGH SHAW was born February 11, 1928, the son of
Bertha L (Callen) and James J Shaw. On June 30, 1951 he married
ANNE COPELAND. They had no children.

1,212-ERLA J SHAW/ Bertha L Callen/ Hugh S/ Thomas J/ James/ Hugh
Sr/ Patrick Callen

(33I)ERLA JANE SHAW was born May 25, 1924, the daughter of Bertha
L (Callen) and James J Shaw. On September 28, 1946 she married
EDWARD WILHELM.

Children

twin i boy-
twin ii girl-
iii boy-
iv Raymond Wilhelm-Nov 9, 195_

1,213-BILL A SHAW/ Bertha L Callen/ Hugh S/ Thomas J/ James/ Hugh
Sr/ Patrick Callen

(33I)BILL ALVIN SHAW was born October 6, 1925, the youngest son of
Bertha L (Callen) and James J Shaw. On June 2, 19__ he married
HILDEGARDE PLASS.

Only Child

i David Shaw-b Sept 28, 195_

1,214-DOROTHY CALLEN/ Harold/ James H/ Thomas J/ James/ Hugh Sr/
Patrick Callen

(33I)DOROTHY CALLEN was born December 17, 1922, the daughter of
Harold and Gladys (Stopp) Callen. Dorothy married EARL MCKINLEY.

Children

i William McKinley-b June 10, 1940
ii Jean McKinley-b Nov 21, 1942
m CHARLES MOON

1,215-DON CALLEN/ Harold/ James H/ Thomas J/ James/ Hugh Sr/
Patrick Callen

(33I)DON CALLEN was the son of Harold and Gladys (Stopp) Callen.

The name of his wife is not known at this time.

Only Child

i John Jay Callen-b Oct 9, 1966

1,216-MARJORIE CALLEN/ Harold/ James H/ Thomas J/ James/ Hugh Sr/
Patrick Callen

(33I)MARJORIE CALLEN was the daughter of Harold and Helen (Stoltz)
Callen. She married ALLEN METTLER.

Children

i Stephen Mettler-b
ii Melinda Mettler-b

1,217-JAMES CALLEN/ Harold/ James H/ Thomas J/ James/ Hugh Sr/
Patrick Callen

(33I)JAMES CALLEN was the son of Harold and Helen (Stoltz)
Callen. He married SHIRLEY RUTH BENTLEY.

Children

i Deborah Christine Callen-b June 11, 1953
ii Jody Lee Callen-b Nov 2, 1955
iii Brenda Louise Callen-b Oct 31, 1961
iv Phillip James Callen-b Sept 30, 1963

1,218-BETTY CALLEN/ Jay/ James H/ Thomas J/ James/ Hugh Sr/
Patrick Callen

(33I)BETTY CALLEN was born January 9, 1924, the daughter of Jay
and Elva (Peterson) Callen. She married FRANK M NICHOLS.

Children

i Frank Michael Nichols-b Apr 6, 1945
ii Debra Joan Nichols-b June 8, 1950

1,219-ROBERT CALLEN/ Jay/ James H/ Thomas J/ James/ Hugh Sr/
Patrick Callen

(33I)ROBERT CALLEN was born December 24, 192_, the son of Jay and
Elva (Peterson) Callen. He married BONNIE DILLON.

Children

twin i Robert Bruce Callen-b July 21, 1947
twin ii Thomas Bradley Callen-b Sept 26, 1949
iii John Randall Callen-b Sept 26, 1949

1,220-PATRICIA CALLEN/ Kenneth/ James H/ Thomas J/ James/ Hugh
Sr/ Patrick Callen

(33I)PATRICIA CALLEN was born June 27, 1936, the daughter of
Kenneth and Louise (Murray) Callen. On August 3, 1957 she married
RAYMOND L AUSTIN, who was born February 15, 1935.

Children

- i Kimberly Lynn Austin-b Aug 25, 1958
- ii Raymond Scott Austin-b May 28, 1963

1,221-HARRY K CALLEN/ Kenneth/ James H/ Thomas J/ James/ Hugh Sr/ Patrick

(33I)HARRY KENNETH CALLEN was born October 31, 1941, the son of Kenneth and Louise (Murray) Callen. He married DORIS KERLE who was born June 30, 1942.

Children

- i Theodore Kenneth Callen-b Feb 15, 1965
- ii Timothy Joseph Callen-b Feb 26, 1969
- iii Christa Lee Callen-b Sept 12, 1970
- iv Richard Michael Callen-b Dec 19, 1971

1,222-DONALD R CALLEN JR/ Donald R Callen/ Elmo H/ Hugh W/ Samuel/ Hugh Sr/ Patrick Callen

(34B)DONALD RICKARD CALLEN JR is the son of Donald Rickard and Ethel May (Rumbaugh) Callen.

Child

- i Rickard Patrick Callen-b ca 1956

1,223-WINIFRED C ALBRIGHT/ Hazel I Callen/ Frederick A/ John H/ Watson/ Hugh Sr/ Patrick Callen

(35A)WINIFRED CLAIRE ALBRIGHT was born May 10, 1916, in Republic, Perry Co. Washington. She married JOSEPH JAMES SOUZA, who was born October 30, 1912 in Auburn, Placer Co, California. Joseph died on July 21, 1942 and is buried in Auburn, Ca. Winifred married again and lives in Auburn.

Children

- 1,273 i Winifred Souza-b 1935
- ii Barbara Souza- m Mr. KIESEWETTER divorced

1,224-JOHN L CALLEN JR/ John L/ Frederick A/ John H/ Watson/ Hugh Sr/ Patrick Callen

(35M)JOHN LEONARD CALLEN JR was born June 7, 1931 in Republic, Washington. He is the son of John L and Fern (Hicks) Callen. He married Elnora Deloris Stoller who was born February 11, 1935 in Lewistown, Montana. They are divorced. Jack is the owner of a mechanics shop and manufacturer of "the Stove That Jack Built" wood stoves. Elnora is a retired registered nurse.

Children

- 1,274 i Susan Marie Callen-b June 9, 1954
- ii John Michael Callen-b June 20, 1955
- 1,275 iii Shirley Ann Callen-b Mar 19, 1957
- iv Thomas Edward Callen-b Jan 10, 1959
- d June 10, 1980 in Kooskia, Id buried Spokane Wa
- 1,276 v William Frederick Callen-b July 8, 1961
- 1,277 vi Katherine Elizabeth Callen-b Sept 25, 1963

1,225-PEGGY ALLEN/ Lucill M Callen/ George W/ John H/ Watson/ Hugh Sr/ Patrick Callen

(35B)PEGGY ALLEN was born on November 28, 1941, the daughter of Lucill M (Callen) and Maurice Isaac Allen. She is a co-researcher and has contributed research to this book. She teaches high school in Denver Colorado.

1,226-CRAIG C CALLEN/ William C/ Charles B/ Alvin C/ Watson/ Hugh Sr/ Patrick Callen

(33F)CRAIG CHARLES CALLEN was born on June 27, 1956, the son of William Charles and Maurine Elizabeth (Bear) Callen. By occupation he is a dentist and lives in Mansfield, Ohio. He married LINDA MARIE MATTERN, who was born September 19, 1962.

1,227-BARRY L CALLEN/ Robert C/ Charles B/ Alvin C/ Watson/ Hugh Sr/ Patrick Callen

(33G)BARRY LEE CALLEN was born July 10, 1941 in New Brighton, Pa, the son of Robert C and Charlotte Marie (VanArsdale) Callen. He married ARLENE COOLEY on August 10, 1963, in New Brighton, Pa.

He has earned several academic degrees; Bachelor of Arts; Master of Divinity; Master of Theology; Doctor of Religion; and Doctor of Education. He is an ordained minister in the Church of God. He is currently serving as Vice-President for Academic Affairs and Dean of the College, at Anderson College, Anderson, Indiana.

Only Child

1 Todd O'Neil Callen-b Jul 29, 1967

1,228-MICHAEL CALLEN/ Alvin C/ Samuel W/ Alvin C/ Watson/ Hugh Sr/ Patrick Callen

(33H)MICHAEL CALLEN was born March 3, 1949, the son of Alvin C Callen III. He currently lives in Grandview, Missouri

1,229-VICTOR A CALLEN/ Frederick C/ Philo L/ Alvin C/ Watson/ Hugh Sr/ Patrick Callen

(35N)VICTOR ALAN CALLEN was born October 8, 1940 in Rockford, Illinois, the son of Frederick C and Marjorie D (Gould) Callen. Victor is a programming manager. He is divorced. He is living in Sacramento, California.

Children

1 Michael Stanley Callen-b Dec 8, 1963
11 Vicki Charlene Callen-b Apr 2, 1965

1,230-JOHN LIVENGOOD/ Adelaide Crytzer/ Ida Steele/ Sarah Rayburn/ Matthew/ Eleanor Callen/ Patrick Callen

(32)JOHN LIVENGOOD was born July 17, 1944, the son of Adelaide (Crytzer) and Raymond Livengood. He married CANDICE, she is law

librarian at the Butler County courthouse, Butler Co, Pa, and she enjoys doing family research.

Children

i Bryan Livengood-b June 22, 1970
ii Kelly Livengood-b March 9, 1972
twin iii Justin Livengood-b Aug 31, 1976
twin iv John Livengood-b Aug 31, 1976

1,231-MARY B LIVENGOOD/ Adalaide Crytzer/ Ida Steele/ Sarah Rayburn/ Matthew/ Eleanor Callen/ Patrick Callen
(32)MARY BETH LIVENGOOD is the daughter of Adalaide (Crytzer) and Raymond Livengood. She married ALBERT FOSTER, they are now divorced.

Children

i John Foster-b
ii Jody Foster-b

1,232-ELLEN S LIVENGOOD/ Adalaide Crytzer/ Ida Steele/ Sarah Rayburn/ Matthew/ Eleanor Callen/ Patrick Callen
(32)ELLEN SUE LIVENGOOD is the daughter of Adalaide (Crytzer) and Raymond Livengood. She married THOMAS ALLEN.

Child

i George Allen-b

1,233-WILMA M CALLEN/ Franklin L/ Leigh B/ David D C/ James F/ David/ Patrick Callen

(37F)WILMA MAY CALLEN was born April 18, 1937 in Hamilton, Kansas. She is the daughter of Franklin L and Esther (Brothers) Callen. On August 20, 1956 in Madison, Kansas she married ROBERT KEITH MARLAR. Robert was born August 17, 1932. Wilma is a letter carrier, Robert is a county worker.

Children

i Melinda Lea Marlar-b Jan 28, 1961
ii Felicia Ann Marlar-b Apr 30, 1963

1,234-JUDITH E MARLOVITS/ Gwenleen M Callen/ Otto O/ David D/ Arthur F/ David/ Patrick Callen

(37A)JUDITH ELAINE MARLOVITS was born August 24, 1946. She married on July 23, 1964 to WAYNE CORRIE.

Children

i Brett Corrie-b Dec 24, 1970 Sunol, Ca
ii Lisa Corrie-b Jun 4, 1975 Fremont, Ca

1,235-GARY G CALLEN/ Lloyd L/ Otto O/ David D/ Arthur F/ David/
Patrick Callen

(37A)GARY GLENN CALLEN was born October 12, 1950 in Artesia, California, he is the son of Lloyd L and Hazel J (Kinney) Callen. Gary married 1st wife JOAN DIMMOCK, there were no children by this marriage. His 2nd wife was PAMELA MANN there was one child from this marriage. Gary's third wife was SALLEY NICHOLS, there were no children by this marriage. Gary's fourth wife is PAULETTE FULLER, there are three children by this marriage.

Children of Pamela

i Krista Kay Callen-b Sept 15, 1972

Children of Paulette

ii Rebecca R Callen-b Jun 3, 1983

iii Danny D Callen-b Aug 2, 1985

iv Katelin K Callen-b Oct 31, 1987

1,236-KEVIN K CALLEN/ Lloyd L/ Otto O/ David D/ Arthur F/ David/
Patrick Callen

(37A)KEVIN KINNEY CALLEN was born March 4, 1956 in Vallejo California, the son of Lloyd L and Hazel (Kinney) Callen. He married DEBBIE McCAFERY Simms.

Children

i Kevin Kinney Callen, Jr-b Oct 31, 1984

ii Codi Catherine Callen-b Feb 27, 1986

S/S Jordi Simms

S/D Sarry Simms

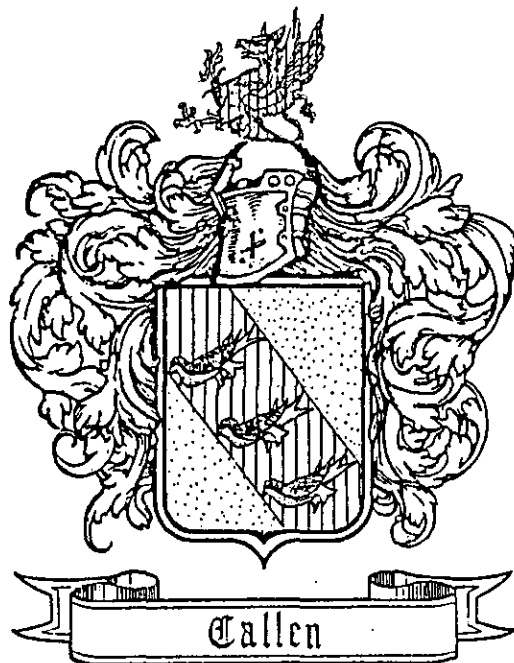

LINE OF PATRICK CALLEN - 8TH GENERATION

1,237-DWANE P SIMMONS/ Cecelia L Callen/ Perle/ Alpheus/ Hugh/ Thomas/ Hugh Sr/ Patrick Callen

(33I)"DWANE PERLE SIMMONS was born August 16, 1927 in Long Beech, Los Angeles County, Calif. He married GLADYS GERALDINE LYNN, May 3, 1947 in the Methodist Church, Las Vegas, Nevada. Geraldine was born in Orange, Calif..."

Children

1,278 i Keith Lynn Simmons-b Aug 7, 1948
1,279 ii Carol Leanna Simmons-b Mar 11, 1952

1,238-DWIGHT W SIMMONS/ Cecelia L Callen/ Perle/ Alpheus/ Hugh/ Thomas/ Hugh Sr/ Patrick Callen

(33I)"DWIGHT WILLIAM SIMMONS was born August 12, 1928 in Long Beach, Calif. He married DOROTHY JEAN BIVENS, October 25, 1947 in San Bernardino, Calif. Jean was born in Crook, Colorado, June 24, 1928..."

Children

1,280 i John Erwin Simmons-b June 4, 1951 m SUSAN FRIZBEE
 ii Dale Jean Simmons-b May 14, 1953

1,239-WILLIAM A CALLEN/ William A/ Perle/ Alpheus/ Hugh/ Thomas/ Hugh Sr/ Patrick Callen

(33I)WILLIAM ARTHUR CALLEN was born September 18, 1935 in Corsica, Pennsylvania. "I was raised in the Sigel and Corsica area of Penna. I joined the Navy in 1954 and later settled in San Jose, California... I remember the following Callen's from my childhood; Grace and Jacob Tibbons, Elsie Ransell Callen, and remember my Mother mentioning Mabel Callen..."

On August 23, 1958 in Altadena, California, he married JOAN CAROL SCHMITZ who was born in Los Angeles, Ca. William is a manufacturing manager. They live in San Jose California.

Children

1,281 i Catherine Marie Callen-b Mar 21, 1960
1,282 ii William Arthur Callen II-b Jan 26, 1961
1,283 iii Teresa Ann Callen-b Jan 11, 1963
1,284 iv Carol Janice Callen-b Mar 3, 1964

1,240-MARY C CALLEN/ William A/ Perle/ Alpheus/ Hugh/ Thomas/ Hugh Sr/ Patrick Callen

(33I)MARY CATHERINE CALLEN was born January 15, 1937. On April 2, 1955 she married CHARLES N AMES.

Children

i Rhonda K Ames-b Oct 29, 1955
ii Lori Ann Ames-b May 14, 1958
iii Karen Lea Ames-b Nov 26, 1959
iv Lisa Marie Ames-b Feb 19, 1962

1,241-BARBARA L CALLEN/ William A/ Perle/ Alpheus/ Hugh/ Thomas/
Hugh Sr/ Patrick Callen

(33I)BARBARA LEA CALLEN was born May 12, 1938, the daughter of William A and Catherine E (Kerr) Callen. She married DONALD LaFOND who was born February 3, 1938. They have no children

1,242-JACK L CALLEN/ William A/ Perle/ Alpheus/ Hugh/ Thomas/
Hugh Sr/ Patrick Callen

(33I)JACK LAWRENCE CALLEN was born August 4, 1940, the son of William A and Catherine E (Kerr) Callen. He married JOAN K BOWERSOX who was born June 9, 1940.

Children

- i Rodney Callen-b Nov 6, 1959
- ii Karla Callen-b Dec 21, 1960
- iii Kristen Callen-b June 28, 1966
- iv Randy Callen-b June 20, 1968

1,243-JEFFERY A CALLEN/ Arthur B/ Burl A/ William T/ John/ Thomas/
Hugh Sr/ Patrick Callen

(33G)JEFFERY ARTHUR CALLEN was born November 15, 1954 in Charleston, West Virginia, the son of Arthur Burl and Betty Lou (Samples) Callen. His occupation is iron worker for the Union Carbide Corp. He married TERESA JO MEADOWS who was born January 13, 1954 in Charleston.

Children

- i Jeremy Shawn Callen-b Dec 14, 1975
- ii Jason Patrick Callen-b Feb 21, 1977
- iii Leah Nicole Callen-b Dec 28, 1980

1,244-HARVEY G CALLEN/ Lloyd T/ Charles J/ James A/ John/ Thomas/
Hugh Sr/ Patrick Callen

HARVEY GORDON CALLEN was born August 14, 1943, in Butler Co, Pennsylvania, the son of Lloyd T and Olive L (Gibson) Callen. He married MYRTLE E CLAYPOOL who was born February 4, 1947. Harvey works for Morse Controls in Hudson, Ohio.

Children

- i Bruce Allen Callen-b May 9, 1966 d Dec 12, 1967
buried in Bessimer Pa.
- ii Randy Lee Callen-b Aug 8, 1967
- 1,285 iii Russel Eugene Callen-b Dec 26, 1968
- iv April Geni Callen-b Aug 24, 1971

1,245-JOHN J CALLEN/ Lloyd T/ Charles J/ James A/ John/ Thomas/
Hugh Sr/ Patrick Callen

JOHN JAY CALLEN was born November 4, 1944, in New York, the son of Lloyd T and Olive L (Gibson) Callen. He married BEVERLY JEAN MEEKINS by whom he had three children. After their divorce he married TERRI WALLACE. John is a long distance truck driver.

Children

- 1,286 i Kimberly Joy Callen-b Sept 30, 1966
 ii Lori Jean Callen-b Sept 29, 1968
 iii Holly Joanne Callen-b Jul 25, 1971

1,246-LOUIS T CALLEN/ Lloyd T/ Charles J/ James A/ John/ Thomas/
Hugh Sr/ Patrick Callen

LOUIS TRUDELL CALLEN was born November 13, 1945, in Butler Co, Pa,
the son of Lloyd Trudell and Olive L (Gibson) Callen. He married
DIANE LEHMAN who was born November 22, 1949. Louis served in the
Navy.

Children

- i Dawn Renee Callen-b Jan 24, 1971
ii Charles Lee Callen-b Jun 22, 1973
iii Beth Elaine Callen-b Jul 19, 1974

1,247-EDNA M CALLEN/ Lloyd T/ Charles J/ James A/ John/ Thomas/
Hugh Sr/ Patrick Callen

EDNA MARIE CALLEN was born September 11, 1947 in Buena Vista,
Butler Co, Pa., the daughter of Lloyd T and Olive (Gibson) Callen.
She earned an Associate Degree in Executive Secretarial Sciences at
the University of Akron, and is currently the Office Manager for
Jost Tire Service in Akron, Ohio. She married THOMAS F MCNELLIS on
September 28, 1968. Tom was born in Akron, Ohio on April 22, 1942,
the son of Frank and Mary (Callahan) McNellis.

Edna is an active member of the Highview Ave Baptist Church in
Akron, singing in the choir and teaching Sunday School. She is a
co-researcher and co-author of this book.

Children

- 1,287 i Stephen A McNellis-b Dec 17, 1969
1,288 ii David Thomas McNellis-b Dec 14, 1970

1,248-BEATRICE L CALLEN/ Lloyd T/ Charles J/ James A/ John/
Thomas/ Hugh Sr/ Patrick Callen

BEATRICE LINDA CALLEN was born December 1, 1950, in Ohio, the
daughter of Lloyd T and Olive (Gibson) Callen. She earned an
Associate Degree in Mechanical Engineering and was employed at
Goodyear Areospace. She is currently working on her Bachelor's
degree in Physics.

Bea was married 1st to CHARLES R LEMASTERS. After their divorce she
married ROBERT JEROME SARGENT. After her second divorce she had her
name legally changed to Beatrice THOMPSON. Bea is now married to
JAMES EDWARD THEIN who was born November 20, 1946.

Children

- i Robert James Lemasters-b Mar 5, 1969
ii Jason Scott Sargent Thompson-b Aug 30, 1973

1,249-DOROTHY G CALLEN/ Lloyd T/ Charles J/ James A/ John/ Thomas/
Hugh Sr/ Patrick Callen

DOROTHY GRACE CALLEN was born August 11, 1952 in Ohio, the daughter of Lloyd T and Olive (Gibson) Callen. She married JOHN DAVID BOOFER and is now divorced. Dorothy works for a chain grocery store in the Dell.

Only Child

i Michael David Boofer-b Jul 13, 1973

1,250-WILLIAM G CALLEN/ Lloyd T/ Charles J/ James A/ John/ Thomas/
Hugh Sr/ Patrick Callen

WILLIAM GEORGE CALLEN "BILL" was born April 9, 1954 in Ohio, the son of Lloyd and Olive (Gibson) Callen. Bill served in the Air Force. He has earned a Bachelors Degree in Electrical Engineering, and is working on Tinker Air Force Base in Oklahoma City, Oklahoma. He married CAROLINE SUE ANDERSON, who was born January 7, 1950.

Children

- i "Tony" Antonio Jose Callen-b Jan 8, 1972
- ii Mary Olive Callen-b Jun 22, 1977
- iii Josuah Callen-b adopted



TONY



MARY



JOSUAH

1,251-DARLENE B CALLEN/ Lloyd T/ Charles J/ James A/ John/ Thomas/
Hugh Sr/ Patrick Callen

DARLENE BERTHA CALLEN was born August 28, 1956 in Ohio. She married JOHN ROBERT JONES and is living in Fort Myers, Florida. Darlene is a secretary.

Children

- i Gregory Paul Callen-b Nov 1, 1974
- ii "JR" John Robert Jones, Jr-b Aug 29, 1978

1,252-LARRY E CALLEN/ Lloyd T/ Charles J/
James A/ John/ Thomas/Hugh Sr/ Patrick Callen
LARRY EUGENE CALLEN was born August 14,
1959 on his oldest brothers 16th birthday.
He was born in Barberton, Ohio and is the son
of Lloyd T and Olive (Gibson) Callen. Larry
served in the Navy. On March 31, 1990 he
married SHARON ANN YARNELL who was born
September 16, 1956.

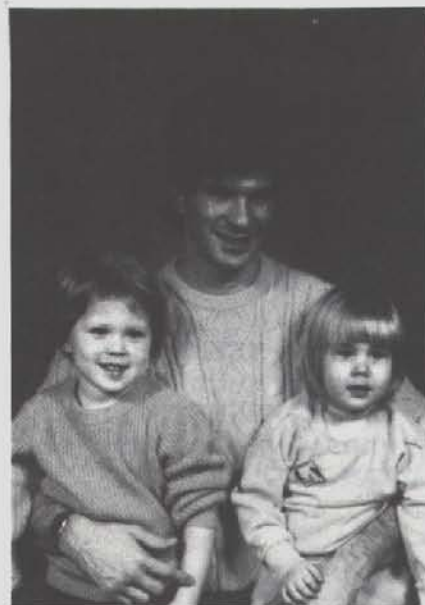

Children
i Jordan Lee Callen-b Oct 8, 1985
ii Leisha Ann Callen-b Sep 27 1986

1,253-DANIEL R CALLEN/ Lloyd T/ Charles J/
James A/ John/ Thomas/Hugh Sr/ Patrick Callen
DANIEL ROY CALLEN was born October 9, 1961
in Barberton, Ohio the son of Lloyd and Olive
(Gibson) Callen. He is a boiler operator and
used car repairman and salesman.

JORDAN, LARRY, LEISHA

1,254-RUTH E CALLEN/ Lloyd T/ Charles J/ James A/ John/ Thomas/
Hugh Sr/ Patrick Callen

RUTH ELAINE CALLEN was born February 25, 1963, in Akron, Ohio, the
daughter of Lloyd and Olive (Gibson) Callen. She married JOHN
MARTIN AKINS who was born April 5, 1959. John and Ruth were
divorced for 2 years, but have remarried to each other. John is
currently serving in the Air Force stationed in Louisiana.

1,255-CAROL A CALLEN/ Thompson L/ Charles J/ James A/ John/
Thomas/ Hugh Sr/ Patrick Callen

(33C)CAROL ANN CALLEN was born December 12, 1944 in Pennsylvania,
the daughter of Thompson and Pauline (Jordan) Callen. She married
JAMES STEWART, and they are divorced.

Children
i James Douglas Stewart-b Apr 18, 1965
ii Jonathan Duane Stewart-b Aug 19, 1966

1,256-JAMES D CALLEN/ Thompson L/ Charles J/ James A/ John/
Thomas/ Hugh Sr/ Patrick Callen

(33C)JAMES DUANE CALLEN was born December 24, 1952 in
Pennsylvania, the son of Thompson and Pauline (Jordan) Callen. He
married JANET LOUISE SAUL, who was born July 13, 1956.

Children
i Jennifer Renee Callen-b Oct 19, 1976
ii Jami Elizabeth Callen-b Oct 13, 1980
iii James Duane Callen II- stillborn
iv James Duane Callen III-b Oct 3, 1984

1,257-CHERYL L CALLEN/ Thompson L/ Charles J/ James A/ John/ Thomas/ Hugh Sr/ Patrick

(33C)"CHERI" CHERYL LYNN CALLEN was born January 24, 1958 in Butler Co, Pa, the daughter of Thompson and Pauline (Jordan) Callen. On June 30, 1984 she married LYLE DEAN DYE who was born February 14, 1958. Cheri (pronounced Cherry) is a school teacher.

Children

i Amy Lynn Dye-b Dec 6, 1985

1,258-KENNETH L CALLEN/ Harold E/ Charles J/ James A/ John/ Thomas/ Hugh Sr/ Patrick Callen

(33C)KENNETH LEE CALLEN was born November 26, 1948 in Pennsylvania, the son of Harold and Anna (Kiley) Callen. He married JEAN ANN THOMAS.

Children

twin i
twin ii
iii

1,259-CHARLES J CALLEN/ Harold E/ Charles J/ James A/ John/ Thomas/ Hugh Sr/ Patrick Callen

(33C)CHARLES JOSIAH CALLEN was born February 15, 1951 in Pennsylvania, the son of Harold and Anna (Kiley) Callen. His father died just a few months after Chuckie was born. He was born with a congenital deformity which crippled his left arm.

1,260-HOWARD W CALLEN/ Walter E/ Charles J/ James A/ John/ Thomas/ Hugh Sr/ Patrick Callen

(33C)HOWARD WAYNE CALLEN was born December 18, 1950, in Pennsylvania, the son of Walter E and Dot (Mackey) Callen. He served in the Air Force. He married DORIS MARIE THOMPSON, who was born February 9, 1949. They are now living in Louisiana.

Children

i Josuah David Callen-b Nov 1980

1,261-DALE W CALLEN/ Walter E/ Charles J/ James A/ John/ Thomas/ Hugh Sr/ Patrick Callen

(33C)DALE WALTER CALLEN was born March 6, 1953 in Pennsylvania the son of Walter E and Dot (Mackey) Callen. He served in the Air Force. He married DONELLA MARIE ELWELL, who was born May 15, 1953. They are now living in Texas.

Children

i Dale Walter Callen, Jr-b Sept 26, 1974
ii Clyde Wayne Callen-b Dec 18, 1976

1,262-LINDA D CALLEN/ Paul E/ Thomas W/ James A/ John/ Thomas/
 Hugh Sr/ Patrick Callen
 (33D)"LINDA DIANE CALLEN was born December 27,
 1946 in Youngstown, Ohio the daughter of Paul and
 Marjorie (Bennett) Callen. On July 22, 1972 in
 the First Church of God, North Apollo, Pa. Linda
 married HOWARD LEE RIDLEN, son of Leo and Dorothy
 Ridlen of Indianapolis, Indiana. Howard was born
 June 11, 1947.



HOWARD & LINDA

Linda is a graduate of Anderson College, Anderson
 Indiana. She is an Engineering Clerk for Bell
 Telephone Company, Indianapolis, Ind. She draws
 blueprints with a computer. Howard is a graduate
 of I.T.T. Technical School in Indianapolis, Ind.
 and is an Engineering technician for the Naval
 Avionics Center in Indianapolis working with
 Weapons Systems Engineering. No children."

1,263-JERRY P CALLEN/ Paul E/ Thomas W/ James A/ John/ Thomas/
 Hugh Sr/ Patrick Callen



JERRY PAUL CALLEN

(33D)"JERRY PAUL CALLEN was born
 Feb 3, 1950 in New Kensington, Pa the son
 of Paul and Marjorie (Bennett) Callen.
 Jerry Paul died February 6, 1951 in New
 Kensington, Pa. from complications after
 pulling scalding water from the stove.

His parents became Christians because of
 his death. They accepted the Lord Jesus
 Christ as their personal Saviour eight
 days after his death. Both of his
 grandmothers and also a couple Aunts
 accepted Christ because of this family
 tragedy.

Jerry Paul is buried in the Greenwood
 Memorial Park Cem in Lower Burrell, Pa."

1,264-DEBORAH S CALLEN/ Paul E/ Thomas W/ James A/ John/ Thomas/
 Hugh Sr/ Patrick Callen

(33D)"DEBORAH SUZZANNE CALLEN was born
 December 3, 1951 in New Kensington, Pa, the
 daughter of Paul and Marjorie (Bennett)
 Callen. On October 3, 1970 in the First
 Church of God, North Apollo, Pa, Debbie
 married WILLIAM JAMES BAILEY, JR. son of
 William James and Arlene (Kriebel) Bailey, Sr
 of Dutch Hill, Pa. Bill was born June 22,
 1949.



PAUL, GABRIEL, LISA
 DEBORAH, BILL, MELISSA

Debbie attended Anderson College, Anderson,
 Indiana. She is a homemaker. Bill served

with the Army in Viet Nam. He attended Penn State College, State College, Pa. He is a graduate of Anderson College, Anderson, Indiana, and a graduate of The School of Theology of Anderson, In. He is a sub-contractor in Franklin, Indiana and he has his own business as a Farrier-horseshoer."

Children

- i William Gabriel Bailey-b Sept 6, 1977
- ii Paul William Bailey-b Aug 27, 1982
- iii Melissa Suzzanne Bailey-b Apr 19, 1985
- iv Lisa Camille Bailey-b Jan 21, 1987

1,265-TIMOTHY M CALLEN/ Paul E/ Thomas W/ James A/ John/ Thomas/
Hugh Sr/ Patrick Callen



(33D)"TIMOTHY MARK CALLEN was born November 8, 1954 in Anderson, Indiana, the son of Paul and Marjorie (Bennett) Callen. On July 13, 1985 in the Carpenters Home Church in Lakeland, Florida, Tim married LYNDA MARY DAVIS, daughter of Cecil Davis of St. Louis, Mo and Joan Holdman of Lake Wales, Florida. Lynda was born May 9, 1951.

TIM, TIM JR
Sarah, Lynda, Tim, Tim Jr
Tim is a graduate of Westmoreland County Community College of Youngwood, Pa and a graduate of Warner Southern College, Lake Wales, Florida. He works for the Department of Agriculture in Bartow, Florida as a lab inspector. Lynda is the lab manager at Polk General Hospital in Bartow, Fla."

Children

- i Timothy Mark Callen, Jr-b May 5, 1988
- ii Sarah Christian Callen-b July 28, 1989
has blue eyes and red hair

1,266-LARRY W CALLEN/ Paul E/ Thoms W/ James A/ John/ Thomas/ Hugh
Sr/ Patrick Callen



(33D)"LARRY WAYNE CALLEN was born October 1, 1956 in Anderson, Indiana, the son of Paul and Marjorie (Bennett) Callen. On June 9, 1979 in the First Church of God, North Apollo, Pa., Larry married VICKIE LYN McMASTERS, the daughter of John and Martha McMasters of Leechburg, Pa. Vickie was born May 21, 1957.

LARRY & VICKIE
Ashley & Amber
Larry is a graduate of Westmoreland County Community College of Youngwood, Pa and a graduate of the Pittsburgh Computer Technical School of Pittsburgh, Pa. Larry is a diesel technician for Gateway Diesel in New Kensington, Pa. Vickie is a homemaker."

VICKIE & LARRY
ASHLEY & AMBER

Children

twin i Amber Laurea Callen-b Feb 10, 1985
twin ii Ashley Renee Callen-b Feb 10, 1985

1.267-LANA Y NALE/ Tillie Callen/ Thomas W/ James A/ John/ Thomas/
Hugh Sr/ Patrick Callen

(33E)LANA YVONNE NALE was born December 10, 1948, in Natrona Heights, Pa. She is the daughter of Tillie (Callen) and Robert E Nale. Lana married Mr. MAJERSKY.

1,268-TINA H BERLIN/ Della Y Callen/ Thomas W/ James A/ John/
Thomas/ Hugh Sr/ Patrick Callen

(33E)TINA HOPE BERLIN was born May 15, 1960, the daughter of Della Y (Callen) and Charles R Berlin. On September 29, 1984 Tina married KEVIN PRUNTY who was born February 5, 1958.

Children

i Joshua Matthew Prunty-b Dec 22, 1985
ii Jessie Ann Prunty-b July 9, 1987

1,269-MICHAEL S CALLEN/ James R/ Raymond A/ Hugh S/ Thomas J/
James/ Hugh Sr/ Patrick Callen

(36B)MICHAEL STEPHEN CALLEN was born September 12, 1950, the son of James Russell and Betty M (Barnard) Pulliam Callen. On September 13, 1975 Michael married ROSE MARIE FREDERICK.

Children

i Katrina Michelle Callen-b Nov 6, 1976
ii Cynthia Nicole Callen-b Oct 19, 1978

1,270-JOSEPH R CALLEN/ James R/ Raymond A/ Hugh S/ Thomas J/
James/ Hugh Sr/ Patrick Callen

(36B)JOSEPH RAYMOND CALLEN was born May 21, 1953, he is the son of James Russell and Betty M (Barnard) Pulliam Callen. On March 28, 1980 he married DEBORAH ARLENE DUSTIN.

1,271-MARY P CALLEN/ James R/ Raymond A/ Hugh S/ Thomas J/ James/
Hugh Sr/ Patrick Callen

(36B)MARY PATRICIA CALLEN was born April 27, 1956, she is the daughter of James Russell and Betty M (Barnard) Pulliam Callen. On September 30, 1978 she married PHILLIP MICHAEL BAKER.

Children

i Jason Matthew Baker-b Feb 25, 1980
ii Hannah Marie Baker-b Oct 5, 1981
iii David Michael Baker-b Sept 28, 1983

1,272-ANNE E CALLEN/ James R/ Raymond A/ Hugh S/ Thomas J/ James/
Hugh Sr/ Patrick Callen

(36B)ANNE ELIZABETH CALLEN was born May 17, 1957, she is the
daughter of James Russell and Betty M (Barnard) Pulliam Callen. On
September 27, 1980 she married RALPH STANLEY PRICE, JR.

Children

- i Christopher Michael Price-b Feb 25, 1982
- ii Robert Allen Price-b Feb 1, 1986

1,273-WINIFRED SOUZA/ Winifred Albright/ Hazel I Callen/ Frederick
A/ John H/ Watson/ Hugh Sr/ Patrick Callen

(35A)WINIFRED SOUZA "WIN" was born in 1935 in Auburn, California
the daughter of Winifred C (Albright) and Joseph Souza. Win married
DAVID GEORGE BALLENGER. She is a co-researcher and co-writer of
this book. Win suggested the name for "The Callen Chronicles". She
died July 1989 of Lukemia.

Children

- 1,289 i Keith Ballenger-b ca 1953
- twin 1,290 ii Kathleen Ballenger-b ca 1955
- twin 1,291 iii Kevin Ballenger-b ca 1955

1,274-SUSAN M CALLEN/ John L Jr/ John L Sr/ Frederick A/ John H/
Watson/ Hugh Sr/ Patrick Callen

(35M)SUSAN MARIE CALLEN was born June 9, 1954. On December 31,
1983 she married ANDREW STEVEN BORDGES.

Children

- S/D Christina Bordges-b May 18, 1976
- S/S Jason Bordges-b Mar 2, 1978
- i Ashley Marie Bordges-b June 16, 1989

1,275-SHIRLEY A CALLEN/ John L Jr/ John L Sr/ Frederick A/ John
H/ Watson/ Hugh Sr/ Patrick Callen

(35M)SHIRLEY ANN CALLEN was born March 19, 1957. On June 9, 1978
she married JOHN DOUGLAS MIKOTA.

Only Child

- i Thomas Ryan Mikota-b Aug 2, 1979

1,276-WILLIAM F CALLEN/ John L Jr/ John L Sr/ Frederick A/ John
H/ Watson/ Hugh Sr/ Patrick Callen

(35M)WILLIAM FREDERICK CALLEN was born July 8, 1961. On August
10, 1984 he married JEANNETTE MARIE MURRELL.

Children

- S/S Aaron Lee-b Oct 27, 1973
- S/S Roger David-b June 1, 1976
- S/S Logan Paul-b June 27, 1984
- i Molly Ann Callen-b May 3, 1985

1,277-KATHERINE E CALLEN/ John L Jr/ John L Sr/ Frederick A/ John
H/ Watson/ Hugh Sr/ Patrick Callen

(35M)KATHERINE ELIZABETH CALLEN was born September 25, 1963. on
May 7, 1988 she married STEVEN PATRICK PETERSON.

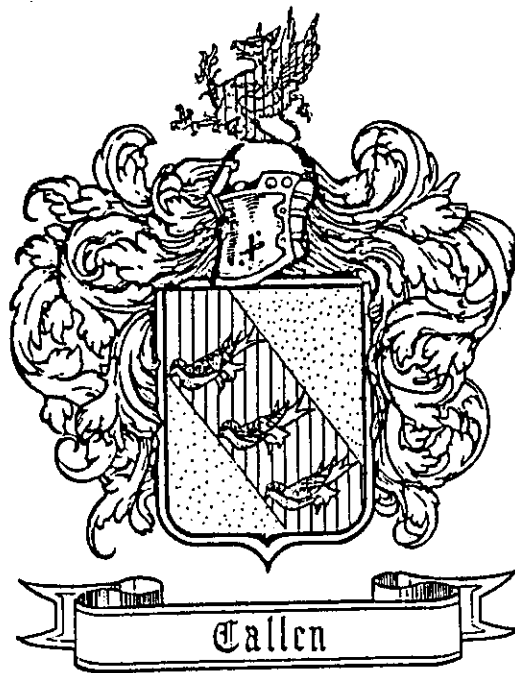

LINE OF PATRICK CALLEN - 9TH GENERATION

1,278-KEITH L SIMMONS/ Dwane P/ Cecelia L Callen/ Perle/ Alpheus/
Hugh/ Thomas/ Hugh Sr/ Patrick

(90)KEITH LYNN SIMMONS was born August 7, 1948 in San Bernardino,
California., the son of Dwane P and Gladys G (Lynn) Callen. "Keith
first married and divorced CANDICE (ARTHUR) BALLARD, date unknown.
He later married CHRISTINE BALOG, June 1, 1983 in Bright Angel Area,
South rim of the Grand Canyon, Arizona."

1,279-CAROL L SIMMONS/ Dwane P/ Cecelia L Callen/ Perle/ Alpheus/
Hugh/ Thomas/ Hugh Sr/ Patrick

(33I)"CAROL LEANNA SIMMONS was born March 11, 1952 in San
Bernardino, California. She married DWANE PELAZINI, June 5, 1982 in
Los Vegas, Nevada. Dwane was born September 24, 1953."

1,280-DALE J SIMMONS/ Dwight W/ Cecelia L Callen/ Perle/ Alpheus/
Hugh/ Thomas/ Hugh Sr/ Patrick Callen

(33I)"DALE JEAN SIMMONS was born May 14, 1953. She married JAMES
ROBERT COVINGTON.

Children

- i Jim Covington-
- ii Dale Covington-
- iii Mary Covington-
- iv Bill Covington-
- v Christopher Covington-
- vi Cathleen Covington-
- vii April Covington-

1,281-CATHERINE M CALLEN/ William A/ William A/ Perle/ Alpheus/
Hugh/ Thomas/ Hugh Sr/ Patrick Callen

(33I)CATHERINE MARIE CALLEN was born March 21, 1960, the oldest
daughter of William A and Joan (Schmitz) Callen. Catherine is an
elementary school teacher.

1,282-WILLIAM A CALLEN II/ William A/ William A/ Perle/ Alpheus/
Hugh/ Thomas/ Hugh Sr/ Patrick Callen

(33I)WILLIAM ARTHUR CALLEN II was born January 26, 1961 the oldest
son of William A and Joan (Schmitz) Callen. William is an
operations manager. He married RHONDA WHELIN HALL.

1,283-TERESA A CALLEN/ William A/ William A/ Perle/ Alpheus/ Hugh/
Thomas/ Hugh Sr/ Patrick Callen

(33I)TERESA ANN CALLEN was born January 11, 1963. She is the 3rd
child of William A and Joan (Schmitz) Callen. Teresa married Mr.
RAUCH. She is a hair stylist.

1,284-CAROL J CALLEN/ William A/ William A/ Perle/ Alpheus/ Hugh/ Thomas/ Hugh Sr/ Patrick Callen

(33I)CAROL JANICE CALLEN was born March 3, 1964. She is the youngest child of William A and Joan (Schmitz) Callen. Carol is a Certified Public Accountant.

1,285-RUSSEL E CALLEN/ Harvey G/ Lloyd T/ Charles J/ James A/ John/ Thomas/ Hugh Sr/ Patrick Callen

(33A)RUSSELL EUGENE CALLEN was born December 26, 1968, the son of Harvey G and Myrtle (Claypool) Callen. On February 22, 1990 he married "DeDe" DELORIS SWINEHART who was born September 1974.

1.286-KIMBERLY J CALLEN/ John J/ Lloyd T/ Charles J/ James A/ John/ Thomas/ Hugh Sr/ Patrick Callen

(33A)KIMBERLY JOY CALLEN was born September 30, 1966, she is the oldest daughter of John J and Beverly (Meekins) Callen. She married RONALD RUNYON.

Children

- i Ronald Lee Runyon Jr-b Dec 28, 1983
- ii Dustin Michael Runyon-b Sept 1988 2 lb 9oz

1,287-STEPHEN A McNELLIS/ Edna M Callen/ Lloyd T/ Charles J/ James A/ John/ Thomas/ Hugh Sr/ Patrick Callen

(33A)STEPHEN A McNELLIS was born December 17, 1969, the son of Edna (Callen) and Thomas McNellis. He graduated from Coventry High School in June of 1988 and entered the U.S. Army in July of 1988. He is stationed at Fort Huachuca (Wa-chew-ka) Arizona, in the Military Intelligence Corps working with unmanned airplanes.

1,288-DAVID T McNELLIS/ Edna M Callen/ Lloyd T/ Charles J/ James A/ John/ Thomas/ Hugh Sr/ Patrick Callen

(33A)DAVID THOMAS McNELLIS was born December 14, 1970, the son of Edna (Callen) and Thomas McNellis. He graduated from Coventry High School in June of 1989 and entered the U.S. Navy 2 weeks later. He is currently stationed in San Diego, California. He is a Petty Officer 3rd class working in Interior Communications Electronics on the U.S.S. Independence aircraft carrier.

1,289-KEITH BALLENGER/ Winifred Souza/ Winifred Albright/ Hazel Callen/ Frederick A/ John H/ Watson/ Hugh Sr/ Patrick Callen

(35A)KEITH BALLENGER was born around 1953 the son of David G and Win (Souza) Ballenger. He married KRISTINE SMITH who was born around 1953 and is a nurse. Keith is a pilot.

Children

- i Kara Kristine Ballenger-b ca 1981
- ii Kate Alise Ballenger-b 1984

1,290-KATHLEEN BALLENGER/ Winifred Souza/ Winifred Albright/
Hazel Callen/ Frederick A/ John H/ Watson/ Hugh Sr/ Patrick Callen
(35A)KATHLEEN BALLENGER was born around 1955 (a twin to Kevin) the
daughter of David G and Win (Souza) Ballenger. She married HAROLD
NUNN who was born around 1955.

Children

- i Kaili Kristine Nunn-b 1980
- ii Alia Patricia Nunn-b 1982
- iii Nunn-b 1984

1,291-KEVIN BALLENGER/ Winifred Souza/ Winifred Albright/ Hazel
Callen/ Frederick A/ John H/ Watson/ Hugh Sr/ Patrick Callen
(35A)KEVIN BALLENGER was born around 1955 (a twin to Kathleen).
He is a happy bachelor.

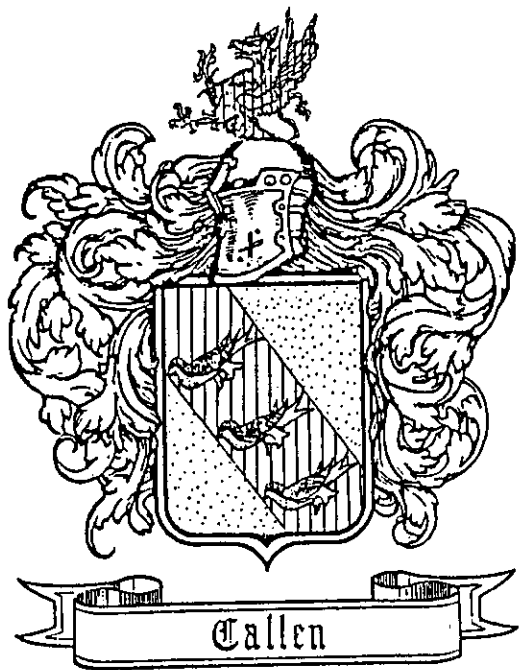

SAMUEL CALLEN, SR

We are unsure of the origin of this Callen line. One possibility is that Samuel Callen Sr was a son of Patrick and Sarah (Hennen) Callen but was not mentioned in Patrick's will. There are several reasons for this theory:

- 1 land transaction between Patrick and Samuel
- 2 the obituary of Samuel's daughter-in-law, Jane (Paul) Callen, was found among Patrick's daughter Nellie (Callen) Rayburn's possessions though added after Nellie's death.
- 3 approximate date of birth is in keeping with Patrick's children
- 4 we have found no transactions or connections between Samuel Sr's lines and any other Callen line to date.

2,1-SAMUEL CALLEN, SR

SAMUEL CALLEN, SR was born around 1783 or earlier, (29)figuring he was at least 20 years old when his first son was born. He married (35A)ANN MILLER daughter of Matthew Miller and Margaret Carnahan.

(4)In 1801 Patrick Callen, of Washington Twp, Westmoreland Co., transferred 150 acres of land on "Beaver Run" or "Beaver Dam Run" to Samuel Callen.

(35A)Samuel served in the War of 1812 and was discharged from the service with the rank of 1st Lieutenant.

(4)In 1820 Patrick Callen deeded a second parcel of land in Washington Twp. to Samuel Callen. In 1823 Patrick conveyed land on Beaver Dam Run to Matthew Miller, (Samuel's father-in-law?).

Samuel died in November of 1849 leaving a will. Since his wife is not mentioned in his will, we can assume she was already deceased.

Children

- 2,2 i Matthew Callen-b ca 1803
- 2,3 ii Robert Miller Callen-b 1806
- 2,4 iii Hugh Callen-b Apr 2, 1808
 - iv Sarah Callen- m (John?) WOODS
 - v Jane Callen- m (Alexander?) THOMPSON
 - vi Matilda Callen- probably never married
- 2,5 vii Margaret Callen-b Apr 15, 1810
- viii Emeley Callen- m Mr. HUNTER
- 2,6 ix Samuel Callen-b Apr 1818

will of SAMUEL CALLEN, SR
(filed in Westmoreland Co, Penna)

The last will and testament of Samuel Callen Snr. of the Township of Washington, County of Westmoreland

In the name of God I Samuel Callen being weak of body but of sound mind and memory and Considering the uncertainty of this mortal life do make this my last will and testament as follows viz:

I commend my Soul to God who gave it and my body be buried in a decent and Christian manner by my Executors hereafter appointed and for Such worldly goods as God has blest me with I will and dispose of as follows:

I will and require my Executors to Sell my real or free hold estate as soon as Convenient after my deceas for the best price that can be obtained for it, and my personal property that is not herein after disposed of I will that my Executors Sell and pay my Just debts and funeral expences from the proceeds of the Sale thereof.

I will and bequeath to the heirs of my daughter Sarah Woods deceased one dollar and my Son Samuel Callen and daughter Jane Thompson one dollar each and my grand daughter Sidney Callen daughter of my Son Hugh Callen deceased I will and bequeath the Sum of twenty dollars and to my daughter Matilda Callen I will and bequeath one hundred dollars her bed and bedding and all the household and kichen furniture. And to my Sons Matthew Callen, Robert M Callen and my daughters Margret Dickey and Emley Hunter I will and bequeath all the resedue and Remainder of my estate to be devided equal and Share alike

And my Executors to colect all my out standing debts

And lastly I appoint my Son Matthew Callen and Son-in-law John M Dickey Executors of this my last will and testament

In witness whereof I have hereunto Set my hand and Seal the eighth Day of November in the year of our Lord one thousand eight hundred and forty nine

Samuel Callen seal

Signed Sealed published and decleared by the above named Samuel Callen to be his last will and testament in presence of us who at his request and in his presents have Subscribed our names as witnesses thereunto

Alexander Thompson
William K Kilborn

LINE OF SAMUEL CALLEN, SR - 2ND GENERATION

2,2-MATTHEW CALLEN/Samuel Callen Sr

(29)MATTHEW CALLEN was born around 1803. (9)He was a carpenter by trade and helped build St. James Union Church (Reformed and Lutheran) in then Washington Twp, (which later became Bell Township) Westmoreland Co, Penna, along with others including a John Paul.

(9)Matthew married JANE "JENNIE" PAUL daughter of Squire Samuel Paul, one of the first magistrates of Bell Twp, (10)and his wife Jane Porterfield. Jennie was born September 4, 1805.

Matthew died around 1854, Jane died September 6, 1890

Children

(not necessarily in order of birth)

- 2,7 i Sarah Jane Callen-b ca 1834
- ii Eliza M Callen- never married
- iii Samuel P Callen-b ca 1840 lived in Denver, Col
- 2,8 iv Emeline S Callen-b ca 1844
- v Matthew Callen-b ca 1846 apparently died young
- vi Anna Marie Callen-d before 1883
- vii Johanna Callen-d before 1883
- viii Harriet C Callen-b ca 1840 m Mr MYERS
lived in Malcom, Iowa

obituary of MRS. JANE H CALLEN
(newspaper - Malcom, Iowa?)

Died, Sept 6th, 1890, Mrs. Jane H Callen of Malcom, Iowa, aged 85 years and 2 days.

Mrs Callen was a resident of Apollo, she was a native of Westmoreland county, Pa, born and raised in the bounds of old Poke Run church of which her father Samuel Paul, Esq. was an honored elder.

Her pastor was the Rev Francis Laird, D.D., who baptized her in infancy and in her 21st year married her to a very worthy man, Mr. Matthew Callen, who a little more than 40 years ago passed over to the other side.

Of her father's family only two brothers survive her, viz: The venerable John Paul, of Paulton, now in his 88th year and his brother, Maj. James Paul, of Dwight, Ill, aged about 83.

Her five children survive her, viz: Mrs. Dr. McBryer, of Apollo, Pa; Miss Eliza M Callen and Mrs. Harriet C Myers, of Malcom, Ia; Mrs. Emeline S McKnight, of Indiana, Pa., and Samuel, of Denver, Col

All these, her children, had the great privilege of being with their mother in her last days, and in her dying hour.

In July 1851, Mrs. Callen, with her family, removed from Apollo to Elder's Ridge, where for about three years she boarded the students of the academy, who still remember, affectionately, her many acts of kindness.

In Oct, 1855, she moved to Scott county, Iowa, where she remained until eight or nine years ago, when she settled in Malcom, Poweshiek county, where she died.

Mrs. Callen was a woman of good common sense, great energy, generous too, almost to a fault. She looked on the bright side of every thing; she was uniformly pleasant and cheerful and her bright face and sweet smile never failed to cheer others. She had been a member of the Presbyterian Church more than 40 years. First at Apollo; then at Elder's Ridge; after this in Iowa at Bluegrass, Walcott and Malcom.

She was an humble consistent Christain; she had not only the form; but also the power of godliness. She kept watching and waiting, and when her appointed time came the angels of God came down and carried her soul up into Abraham's bosom.

"There remaineth therefore, a rest to the people of God."

"Tis sweet to rest in lively hope,
That when my change shall come,
Angels will hover round my bed,
And waft my spirit home." J.M.J.

2,3-ROBERT MILLER CALLEN/Samuel Callen Sr

(29)ROBERT MILLER CALLEN was born (41)in 1806. He married HARRIET (unknown) who was born around 1810. It appears from census records that he lived most of his life in Washington Twp. (later became Bell Twp) Westmoreland Co, removing to the town of Apollo, which was located on the north side of the Kiskiminetas River in Armstrong Co, before 1850.

(4)Robert died July 26, 1885 at 6 A.M., (41)but his headstone in Poke Run Cemetery, Apollo, Pa shows his death date as 1888. Headstones for his children read "Dau. of R.M. and H. Callen", but another stone nearby reads "Margaret, wife of R.M. Callen, died June 3, 1870, aged 61 y". Was Robert married twice, or was his wife Harriet Margaret?

Children

- 2,9 i Caroline M Callen-b 1835
- 2,10 ii Rebecca Jane Callen-b 1836
- iii Mary E Callen-b ca 1844 d Sep 14, 1868 aged 24 years
- iv Louisa M Callen-b ca 1838/1845? d Sept 29, 1864 aged 26 years-died of grief at her brother's death, they say (One record says that Louise was only 1 year older than Theophilus)
- 2,11 iv Theophilus Callen-b ca 1846
- 2,12 v Harriet S Callen-b 1846

2,12 vi Adelaid Callen-b 1848
vii Sarah Callen-b ca 1851 d Feb 6, 1871
2,12 viii Elmira-b 1852

Will of ROBERT MILLER CALLEN
(filed in Bell Twp, Westmoreland Co, Pa)

In the name of God Amen I Robert M Callen of Bell Township, Westmoreland County and State of Pennsylvania Being Sick and weak in body but of sound Mind Memory and understanding praised be God for it, Considering the certainty of death and the uncertainty of the time thereof and to the End. I may be the better prepared to leave this world whenever it Shall please God to Call me Hence do therefore make and declair this My last will and testament in manner following, that is to say.

first and principally I commend My Soul into the hands of Almighty God My creator and as to my worldly goods.

In the first place I order that all my just debts funeral Expenses and charges of proving this My will be in the first place fully Paid, and Satisfied and after the Payment thereof and every part,

I bequeath to My Daughter Caroline M intermarried with J.H. McKeuwn - Twelve Hundred Dollars in the following Payments Six Hundred dollars in one year after My decease, and Six Hundred Dollars in Two years after My decease.

I bequeath to Rebecca Jane My Daughter Intermarried with Robert McKeuwn now decd Twelve Hundred dollars in the following Manner Six Hundred dollars in one year and Six Hundred dollars in Two years after my decease

I bequeath to My Three daughters Harriet Callen Adalade Callen and Elmira Callen My Farm being my homestead togerher with all My personal property, such as Household and Kitchen Furniture, Horses and Cows Sheep & Hogs, and all goods and Chattels of any Kind: belonging to me, and the money bequeathed to My Daughters Caroline M McKeuwn and Rebecca McKeuwn out the Cash I have on hands.

And I do hereby nominate, constitute, appoint, My Daughter, Harriet to be My Executor of this My will and testament Hereby revoking all other wills by me at any time heretofore made and declare this only to be my last will and testament

In witness whereof I the said testator Robert M Callen Have to this my last will and testament Set my hand and Seal this ninth day of September A.D. 1884.

Robert M Callen seal

Signed Sealed and declared by the Said testator Robt M Callen as for his last will and testament in the presence of us who in his presence and at his bequest have subscribed as witnesses thereto

Wm Miller D.C. Blair

I R.M. Callen the within Testator do make this codicil to be taken as part of My last will and testament as follows, that is to say

Whereas I have by My Said will given to my Daughter Caroline intermarried with J.H. McKeuwn the sum of Twelve Hundred Dollars in Two Payments, now I do hereby revoke and make this void and in lieu thereof I bequeath to the Said Caroline McKeuwn Thirteen Hundred Dollars to be paid as follows One thousand Dollars at my decease and Three Hundred dollars in three years without Interest after my decease This to be her share in full.

also in lieu of Twelve hundred Dollars to Rebecca My Daughter intermarried with Robert McKeuwn now decd I make void and bequeath to the said Rebecca McKeuwn Thirteen Hundred dollars to be paid as follows One thousand dollars after my death and Three Hundred dollars in three years after my decease without Interest, and this to be her share in full.

In witness whereof I the said Testator Robert M Callen have set My hand and seal this 3rd day of December A.D. 1884

Robert M Callen seal

Signed Sealed and declared by the testator R M Callen as for his codicil to this his will in the presence of us who in his presence and at his request have subsined as witnesses thereto

Wm Miller D.C. Blair

2,4-HUGH CALLEN/Samuel Callen, Sr

HUGH CALLEN was born April 2,1808. (4)He married MARY CHAMBERS daughter of William Chambers Sr. and Frances "Fanny" Bovard. Mary was born in Westmoreland Co in 1805

(35A)"Hugh died intestate (meaning without a will) on March 11, 1846 and left an enormous debt for the time, of some \$2,000.00 He was involved in the building of a bridge over the Kiskiminetas River at Leechburg at the time of his death at the approximate time that the bridge was to have been completed.

"The court ordered the sale of his personal property in an attempt to help satisfy the creditors. It was a traumatic time for Mary Chambers Callen, who lost her husband and two young children, all within a months' time. It is a sad fact that she had to "buy back" her own bedstead for the sum of \$10.00, adding insult to injury.

"The sale of the property was largely a family affair and among those present, in addition to Chambers and Bovards, were Samuel and Matthew Callen."

It appears from the legacy left by Mary Chambers Callen in her will, filed both in Westmoreland & Armstrong Co's, that times improved greatly financially for her.

Mary died November 29, 1889. Hugh and his family are buried in Poke Run Cemetery, in Apollo, Armstrong Co, Pa.

Children

- 2,13 i Frances G "Fanny" Callen-b Jul 28 1833 d Jan 11, 1873
ii Eliza Jane Callen-b Mar 31, 1835 d Jan 25, 1866
iii William Chambers Callen-b Oct 13, 1840 d Apr 7, 1846
iv Sidney P Callen (female)-b Mar 27 1842 d Jul 23 1874
never married
v Amanda Callen-b Nov 10, 1844 d Mar 21, 1846

Will of MARY CHAMBERS CALLEN

(filed in Armstrong & Westmoreland Co's, Penna)

In the name of God, Amen. I Mary Callen of Washing Township in the County of Westmoreland, and State of Pennsylvania; do make this my last will and testament, hereby revoking, and making void all other wills heretofore by me at any time made.

First, I direct that My body be decently interred in the burying ground of the Presbyterian Church of Poke Run, in said County, according to the rights and ceremonies of Said Church, and that my funeral be conducted in a manner corresponding with My Estate and Situation in life:

And as to My worldly Estate which it has pleased God to intrust me with I dispose of the same as follows.

First, I direct that all my debts and funeral expences be paid as soon after my decease as possible by my executor herein after named.

Second, I give and bequeath to my granddaughter Mary C McKnight Five hundred dollars, my daughters Fanny & Sidneys' pictures, and hair flowers, Mr & Mrs McMillens pictures, also a picture of (Stand up for Jesus,) Also Fannys family Bible, My Trunk, family register, & Album.

Third, I give and bequeath unto Katie Chambers, daughters of William & Kezia Chambers, my bed & bedstead, Clock and beauro, with its contents, my Silver Teaspoons, Butter dish, Silver fruit dish, My butter Knife & spoons, two parlor Chairs, all my quilts, large looking Glass, Book stand & tray, Wash bole and pitcher.

Fourth, I give and bequeath to Hetty Chambers half day-plates, Knives & forks, and two parlor Chairs.

Fifth, I give and bequeath to Nannie Chambers, half day-plates, Knives & forks, & two parlor Chairs.

Sixth, I give and bequeath to Kezie Chambers all my Cupboard ware, Coffee Kettle, sofa, all my Carpets & Ruggs, & Gentleman Chairs, and five hundred dollars.

Seventh, I give and devise to my brother William Chambers all my real Estate remaining after the Legacies herein above devised are fully paid and after all my debts and expences of this my Estate are fully settled, and paid, and my Executor herein after named is hereby authorised to sell so much of my real Estate as may be necessary to pay said legacies & expences of any of my said Estate he may Choose,

but the remainder I give & devise to him viz: my farm in Bell Township County of Westmoreland, and State of Pa. Also My house and lot in Apollo Borough County of Armstrong and state of Pennsylvania, to have and to hold both properties to him & his heirs forever on payment by him of the legacies aforesaid

And I do hereby Make and ordain my Brother William Chambers to whom I bequeathed and devised My real Estate herein Executor of this my last will, and testement.

In witness whereof I Mary Callen have to this my last will, written on two half sheets of Paper, Set my hand and seal, this seventh day of June in the year of our Lord one thousand Eight hundred and Eighty Seven.

Mary Callen seal

The writing contained in this and the proceeding half sheet of paper, was signed and sealed by the above named Mary Callen, and by her published and declared to be her last will and testament in the presence of us, who have hereunto Subscribed our names in her presence and in the presence of each other.

J Freatly William H Chambers

I Mary Callen being of Sound mind and memory do on this 23rd day of October A.D. 1889 make and publish this Codicil to my last will and testament. And I hereby rattify all and every bequest and devise heretofore made in the foregoing will and hereby declaire it to be my will that Kazia Chambers wife of William Chambers Shall have Eight hundred dollars in addition to the five hundred dollars bequeathed in this my aforesaid will.

And that Mary McKnight my granddaughter is to have just what is expressed in my will and nothing more

and it is my desire that Wm Chambers my Executor in addition to the devise made in my will Shall have after payment of the above legacies any money that may be left after my decease

Witness my hand and Seal the day above written

Attest
John Coy J Freetly

Mary Callen

2,5-MARGARET CALLEN/ Samuel Callen Sr

MARGARET CALLEN was born (41)April 15, 1810 in Pa, the daughter of Samuel and Ann (Miller) Callen. She married JOHN M DICKEY who was born December 16, 1814 in Pa. (29)It appears that they lived most of their married life in Washington Twp, Westmoreland Co, Pa. They became the guardians of Samuel Miller Callen's children after Samuel's 1st wife died.

John died January 23, 1886, Margaret died January 3, 1899; both are buried in the Poke Run Cemetery, Apollo, Pa

Children

- i Eliza J Dickey-b Aug 20, 1835 d June 30, 1907
- ii Rebecca P Dickey-b Feb 10, 1837 d Mar 2, 1921
- iii William Dickey-b ca 1839
- iv Emeline Dickey-b June 15, 1842 d Oct 4, 1925
- v James M Dickey-b ca 1845
- vi David M Dickey-b ca 1847
- vii Mary D Dickey-b 1850 m Mr. BROSKI
- viii John T Dickey-b ca 1854

2,6-SAMUEL CALLEN/Samuel Callen Sr

SAMUEL CALLEN was born April 1818, in Westmoreland Co, Pa. He was the son of Samuel Callen Sr and Ann (Miller) Callen.

(18)Samuel was married first to ELIZA JANE TORRANCE who was born December 16, 1816, the daughter of Hugh and Mary (Gray) Torrance. Eliza bore Samuel 3 children before her death on April 5, 1853.

Between Eliza's death in 1853 and the Fall of 1854, Samuel had traveled to Iowa.

(30)On November 30, 1854 he married RACHEL J (TOWNSEND) SHOEMAKER who was born August 1829, daughter of Robert and Elizabeth (Hine) Townsend of Armstrong Co, Penna. Rachel was widowed April 30, 1854, just 20 days after her marriage to William Shoemaker while on the way to Blackhawk Co, Iowa, to property owned by her husband.



RACHEL (TOWNSEND) CALLEN

Callen Schoolhouse



Callen Schoolhouse
Nodaway, Missouri

The Callen School was founded and built a mile west of Nodaway in 1870; Samuel Callen, who donated the ground. The roadside schoolhouse still stands. Three generations of the Callens have attended. First was Robert Ray Callen, then his sons: George Francis Callen, Dale Callen, and Lee Callen. George Francis's sons were next: George R. and Robert L. Rickey came along too late to attend the family school. Samuel V. Callen, brother of Robert Ray Callen, had eleven children who received schooling there. Heat came from the wood stove; light from kerosene lamps. The Callen boys walked two and one-half miles to school year round. Forty to fifty students shared one room, one teacher for grades one through eight. Callen School was a community center with box suppers, programs, and "get-togethers". Some remembered teachers are: Norman Chandler, Orville D. James, Alberta Nester, Jane Brushwood, Ethel Anderson, Pauline Griffin, Eldora Hall, and Mary Patterson. Mary Elaine Reece was the last teacher. The school closed in 1954. Two of the very early students still live today — Bill Brown and Henry Bullock. George Francis Callen, owner of the photo, was born August 2, 1921, at Nodaway in the same log house in which his father was born in 1888. On February 21, 1942, he married Georgia Rose King. Francis and Georgia are parents of the above mentioned sons, two granddaughters, two grandsons. A veteran of World War II, Francis Callen now serves as mayor of Amazonia.

by Francis Callen
Amazonia, Missouri

In 1860 the family is shown in the census of the Nebraska Territory, living in or near Brownville, in the SE corner of the state on the Missouri River. Samuel's occupation is shown as Carpenter. (His pension application in 1875 listed his occupation prior to service in the Civil War as "Carpenter and Boat Builder".)

(30) Samuel served in the Civil War from the Fall of 1862 to mid 1863 in the 2nd Nebraska Calvary. He is listed in the 1890 pension list as Hospital Steward, apparently served in this capacity only after being disabled. He would have been in his forties when the War started.

Between 1860 and 1870 the family moved from Nebraska Territory to Andrew County, in the northwest corner of Missouri, north of St. Joseph. (43A) They came down river by barge. It appears that Samuel operated a saw mill in Missouri.

(43A) In 1870 Samuel donated land and built a schoolhouse at Nodaway Station. On August 16, 1870 Samuel, and two others, bought one acre of land in Sec 16, Twp 59, Range 36 in Andrew County. The cost was \$35.00. It is not known if this was the school ground.

On March 30, 1872, Samuel purchased Lot 5 in Sec 19 for \$175.00. On June 18, 1872 he sold part of lot 5, SEQ Sec 19, T59, R 36 to Maguire for \$50. On March 5, 1874 Maguire deeded the lot back to the Callens and on December 23, 1874 they sold it to Simon P Townsend, of Armstrong Co, Pa, brother of Rachel, for \$200.00. Several other transactions are on record in Andrew Co, including a mortgage on a sawmill.

(30) On October 8, 1875, Samuel filed a declaration for original pension of an invalid, as a result of damage to his leg during the Civil War. "The constant jaming and crowding of the horses while in ranks produced upon the left leg, something of the nature of valcose veins. The leg below the knee became very much swollen, until the skin gave way and it burst in the early part of the winter of 1862 & 1863 and from that time to the present it has given me much trouble and unfits me for my former vocation."

The physician's affidavit that accompanied the pension application reads "...in the summer of 1874 (I) as practicing in Andrew Co, Mo was called upon by the aforesaid Samuel Callen to treat a sore on his left leg. I found him suffering from it very much from the effects and unable to perform any labour of any kind. On examination found the bone decayed and advised him to have it amputated below the knee." There is no evidence whether this operation was ever done.

His pension application of 1875 discribes Samuel as 5' 7 1/2" tall, dark complexion, grey hair and grey eyes.

Samuel died on January 10, 1886, at age 67, cause of death was "pyemia" a term describing a severe infection or blood poisoning. Rachel died June 1, 1912, of "dropsy." (38) Both died in Nodaway, Andrew, Co, Missouri. Samuel is buried in the Nodaway cemetery, Rachel's death record says she is buried in the Baptist Cemetery.

Children of Eliza Jane

- 2,14 i Hugh Torrence Callen-b ca 1843
2,15 ii Samuel Miller Callen-b Apr 5, 1845
2,16 iii Margaret Jane Callen-b ca 1847

Children of Rachel

- iv Marietta Callen-b Sept 15, 1855 Davenport Iowa d 1856
2,17 v Robert Townsend Callen-b Sept 2, 1857
2,18 vi Josephine Callen-b Mar 13, 1860
vii Lewis W Callen-b Jul 30, 1862 d before 1870 census
twin viii Emily V Callen- Apr 19, 1864 d before 1870 census
twin ix Rosa A Callen-Apr 19, 1864 d before 1870 census
x Clara E Callen-b Jan 10, 1866 Nodaway, Mo d Oct 1870
2,19 xi Simon "Luther" Callen-b Sept 30, 1869
2,20 xii "Annie" Anna R Callen-b Feb 15, 1873

Will of RACHEL TOWNSEND CALLEN
(filed Andrew County, Missouri)

I, Rachel T. Callen being of sound mind and disposing memory, do make, publish and declare this to be my last Will and Testament.

First:-I will that all my just debts be paid, also the expenses of my funeral.

Second:-I give bequeath and devise to my daughter Josephine Buschman my red cow; and to my son Luther Callen my black cow and black yearling calf.

Third:-I will, give, bequeath and devise One Hundred Dollars to each of the children of Annie Shenks my deceased daughter.

Fourth:-I give, bequeath and devise to Margaret Masterson, my step daughter, One Hundred Dollars; and to Torrence Callen and Miller Callen, my two stepsons, I give and devise One Dollar each.

Fifth:-All of the remainder of my property, real, personal and mixed, of which I shall die seized and possessed. I give, bequeath and devise in equal parts to my two sons, Luther Callen and Robert T. Callen, and to my daughter Josephine Buschman.

Rachel T. Callen

We attest the foregoing will by subscribing our names hereto as witnesses in the presence of Rachel T. Callen this 21st day of April, 1912, who declared the same to be her last Will and Testament.

E.T. Chilcoat W.Z. Colvin

LINE OF SAMUEL CALLEN, SR - 3RD GENERATION

2,7-SARAH JANE CALLEN/ Matthew/ Samuel Callen Sr
(29) SARAH JANE CALLEN was born around 1834, the daughter of Matthew and Jane (Paul) Callen. (10) On October 4, 1855, she married DR. WILLIAM MCBRYAR, (40) son of James and Elizabeth (Dickie) McBryar. William was born Nov 29, 1822 in Pa. He was a medical doctor and lived and practiced medicine in Apollo, Armstrong Co, Pa.

Sarah and William were Presbyterian by faith and attended the Apollo Presbyterian church. William died on June 25, 1905, Sarah died less than two months later on August 5, 1905.

Children

- i Lizzie J McBryar- d before 1883
- ii James C McBryar- d before 1883
- 2,21 iii Ada May McBryar-
- iv William Lyle McBryar-
- v Hattie Dickey McBryar-



S. J. McBryar



W. McBryar M.D.

2,8-EMELINE S CALLEN/ Matthew/ Samuel Callen, Sr
(29)EMELINE S CALLEN was born around 1844. She was under-aged when her father died, and the courts named James Paul as Emeline's and Samuel's guardian.

She married JAMES A MCKNIGHT (35A)who had previously been married to her cousin Eliza Jane Callen daughter of Hugh and Mary Chambers Callen. She later lived in Indiana County, Pa.

2,9-CAROLINE M CALLEN/ Robert M/ Samuel Callen Sr
(29)CAROLINE M CALLEN was born in (41)1835, the oldest daughter of Robert Miller and Harriet (Unknown) Callen. She married JACOB H MCKOWN who was born in 1825. Jacob died in 1904, Caroline died after 1900, both are buried in Poke Run Cemetery, Apollo, Pa.

Children

(May be only partial list)

- i John H McKown-b Mar 29, 1866 d Sept 19, 1870
- ii William McKown-b May 7, 1876 d Feb 27, 1881

2,10-REBECCA J CALLEN/ Robert M/ Samuel Callen Sr
(29)REBECCA JANE CALLEN was born (41)in 1836, the daughter of Robert Miller and Harriet (Unknown) Callen. She married ROBERT MCKOWN who was born in 1820. Robert died in 1884, Rebecca died in 1918, both are buried in the Poke Run Cemetery, Apollo, Pa.

Child(ren)

(May be only partial list)

- i Robert C McKnown-b 1870 d 1944

2,11-THEOPHILUS A CALLEN/ Robert M/ Samuel Callen Sr
(29)THEOPHILUS A CALLEN was the only son of Robert M and Harriet Callen. He was born around 1846. He served in the Civil War as a member of Co. L., 155 Reg't. He was killed at the Battle of Cold Harbor, in Virginia. The following newspaper article tells us his story.

THE KISKIMINETAS SQUAD

taken from The Pittsburgh Press - Sunday, Mar 25, 1973

by GEORGE SWETNAM

"Pittsylvania has had many war heroes...But few individuals or groups could have shown more bravery than the Kiski Squad of 10 farm boys who enlisted together here in the Civil War. They marched into action within days of their induction, and only one ever returned...He was J. King Alter of near Freeport...

FROM SAME AREA

"The others were George Bratton, Theophilus Callen, Alexander Clements, Wilbur Kuhn, William Liken, Duncan McCutcheon, Alexander Richie, James Rowan and Louis Schreiner. All were from the region lying mostly between Pucketa Creek and the Kiskiminetas River, from which the group took its name.

"Things were going badly for the Union in the late summer of 1862. The boys were still in their late teens. But after talking things over, they came to Pittsburgh in a group on Aug. 22, to enlist "for three years or the duration of the war."

"...The ten youths had made up their minds to enlist in the Kier Rifles, a group being recruited here by Capt. Joseph B Sachett with financial backing from Samuel M Kier...

"Men were in demand, and there was little ceremony. They gave their names, ages, height, weight and physical coloration, and were permitted to sign the roll. A surgeon ordered them to run, jump, wrestle and turn hand springs and pronounced them fit for service.

"The Kier Rifles had been planned as a regiment, but a lot of other recruiting was under way, and it wound up as Company E of the 155th Pennsylvania. They were sent without ceremony to Camp Howe, near Oakland, where they were issued blue uniforms, "monkey caps" and oversized Army shoes, which made them feel very awkward in their first training.

"There was no long period of basic training for that regiment. Twelve days later they were on the train to Harrisburg. All along the way people were meeting the train to offer them food.

"On Sept 4, the following day, they were rushed to and through Washington in cattle cars and encamped on Arlington Heights. The following day they were sent out to bury the dead of the defeat at the second battle of Manassas, who had lain on the field for a week.

"Not much more than a week later they were off on forced marches to join the Army of the Potomac at Antietam Creek. Despite an all-day, all-night march on Sept. 15 they were just too late for the battle. But they met many wounded soldiers with makeshift bandages, searching for medical aid. Although the squad had been in service less than a month, its members found plenty of opportunity to see the hazards of war.

"They were soon to learn there were other dangers than enemy guns and bayonets.

"Hardly had they returned to Washington when they received orders to head for Falmouth, Va., to take part in the Peninsular Campaign—an effort to take Richmond from its blind side—through the coastal swamps—and camped at Falmouth.

"They had barely completed their fortification in mid-November when Rowan and Clements died of typhoid fever. Then Schreiner became ill and was the third victim of the epidemic.

"On Dec 13 they were ordered out to take part in an effort to make a pontoon crossing of the Rappahannock at Fredericksburg. Drawn up on a bluff they listened to a battle they could not see, because of

smoke and fog.

"About noon they were ordered down the hill to join in the attack on a stone wall at the foot of Marye's Heights. In a ravine they saw hundreds of rough coffins, ready for use.

"Experienced soldiers might well have quailed, but the Kiski Squad kept its nerve. Kuhn, always a great joker, saw a friend in a corps of stretcher bearers.

"'Be on hand,' he called. 'I'm going to need you!'

BRATTON DIED FIRST

"His jest proved all too true. Despite their best efforts the Union forces were beaten back. Bratton was one of the first to fall in the charge, and Kuhn was mortally wounded, dying that night on the field.

"About a week later, back in camp, Richie died of fever. Six members of the squad had died in a period of five weeks. A little more than a month later McCutcheon died in the hospital to make a seventh. That made seven of the 10, within less than five months after enlistment.

"The others seemed to bear a charmed life for a while, going through battle after battle. Alter, who had been on sick leave, rejoined his unit on the march to Gettysburg. He took part in the capture of Little Round Top, still so ill that he was ordered to the hospital immediately after the battle.

"But even their string of luck was running out.

"On the night of June 2, 1864, during a period of probing attacks leading up to the battle of Cold Harbor, Callen was one of those chosed for outpost picket duty in the noman's land between the armies. He was barely 18.

"At 10 p.m. he relieved an earlier picket, identifying himself, by prior arrangement, with a low whistle. Perhaps it was intercepted by an enemy, for when his relief came at midnight, he was found shot to death, a bullet from the side having entered his head just at the ear.

"A messmate, Sgt. John M Lancaster of Brownsville, and three other volunteers crawled out and returned his body, despite considerable enemy fire in dim moonlight. Next morning his body was buried beneath a young peach tree inside the breastworks, the work being interrupted several times by enemy attacks.

"Just over two weeks later, on June 18, Liken was killed charging the breastworks at Petersburg. And four days afterward, in the same siege, Alter was wounded so severely he could never return to action. A year and three days later he was mustered out, and was the only member of the Kiski Squad to return home alive.

"The story of the Kiski Squad didn't quite end there.

"Callen and Lancaster had been very close during the nearly two years they had served together. And Callen had told the sergeant about his sister, Louisa, just a year older than himself.

"Following the funeral, Lancaster wrote to the Callen family giving an account of the tragedy, and sending a sketch of the grave made by Charles F McKenna, the picket who had found his body.

SHE ANSWERED

"Perhaps Theophilus had written his sister about Lancaster, too, for it was she who answered:

Point Home, near Apollo
June 12, 1864.

John M. Lancaster,
Dear Friend:

We received your letter to father a few days ago, informing us of the death of our only brother. It was a terrible shock to us all...

Your kind letter gave us much comfort and consolation in our deep grief...I hope your lives may be spared, and you and your comrades be permitted to return to your homes...

"The letter must have meant a great deal to Lancaster. Soon after being mustered out of service a year later, he hurried to the Callen home. There he received a shock, Louisa had died a few weeks earlier - from grief, they said - just 20 years of age.

"Having given his heart, John Lancaster was not one to take it back. He went to Virginia with Callen's father in 1866, to retrieve the youth's coffin and return it here for burial beside Louisa. You may see their stone still in the cemetery in Poke Run churchyard.

"It was many years before Lancaster married. And half a century after the war's end he still treasured Louisa's letter, and the sketch by McKenna, which her father had entrusted to his keeping."

2,12-HARRIET, ADELAID, ELMIRA CALLEN/ Robert M/ Samuel Callen Sr

Will of HARRIET CALLEN, ADELAID CALLEN, and ELMIRA CALLEN
(filed Bell Township, Westmoreland Co, Penna)

In the name of God amen

We, Harriet Callen Adelaid Callen, and Elmira Callen of Bell Township in the County of Westmoreland and State of Pennsylvania, Being of sound and disposing mind and memory do make and declare this to be our last will and testament in manner following that is to say

we order that all our just debts funeral expenses and charges of proving this will be in the first place fully paid and Satisfied, and after the payment thereof and every part thereof

First, I Harriet Callen: give and bequeath to Adelaid Callen and Elmira my Share of the farm Situate in Bell Township, Westmoreland County and State of Pennsylvania, Known as the Robrt M Callen Farm, Bequeathed to the said Harriet Callen Adelaid Callen and Elmira Callen by their Father Robert M Callen and with all the appertenance thereunto belonging, together with my Share of all the goods and Chattels debts ready Money, effects of any Kind wheresoever-or whatsoever,

Second I Adelaid Callen, gives & Bequeaths to Harriet Callen and Elmira Callen my Share of the Farm, Herein discribed under the bequeath of Harriet Callen together, with my Share of all the Goods and chattels, debts ready money effects of any Kind whatsoever or wheresoever

Third, I Elmira Callen give & beugeath To Harriet Callen and Adelaid Callen my Share of the farm herein discribed as above together with my Share of all the goods and Chattels, debts ready money effects of any Kind whatsoever or wheresoever.

And we do hereby nominate any of us the Survivers to this will to be the Executors of this our last will and testement hereby making void all other wills heretofore Made and declare this to be our last will and testament witness our hands and seals this 4th day of January AD 1888.

Harriet Callen seal; Adelaid Callen seal; Elmira Callen seal

Signed Sealed published and declared by the Said testators Harriet Callen Adelaid Callen, and Elmira Callen as for their last wills and testament in presence of us who in their presence and at their request have subscribed our names as witnesses thereto

D.C. Blair residing at Bell Township Westmoreland County, Penna
R P Paul Residing at Bell Township Westmoreland County, Penna

2,13-ELIZA JANE CALLEN/ Hugh/ Samuel Callen, Sr
(35A)ELIZA JANE CALLEN was the daughter of Hugh and Mary (Chambers) Callen. She was born on March 31, 1835, probably in Westmoreland Co, Pa. On March 13, 1862 she married JAMES A MCKNIGHT. Eliza died on January 25, 1866 and James McKnight married Eliza's cousin Emeline S Callen.

Children

- i male - died in infancy
- ii Mary Callen McKnight - never married

2,14-HUGH TORRENCE CALLEN/ Samuel/ Samuel Callen, Sr
(29)HUGH TORRENCE CALLEN (called "Hugh" and "Torrence") was the son of Samuel and Eliza Jane Torrence. (43A)He was born October 14, 1842 near Cookstown, Westmoreland Co, Pa. No direct family

information exists about him. The facts of his life are from census records, military affidavits and legal documents signed during his lifetime.

(43A)His family moved to the Pittsburgh area in late 1850 and lived there until Hugh's mother's death in 1853. His father broke up housekeeping and went west to Davenport, Iowa where he remarried in November of 1854.

By 1860, the family had moved to the Nebraska territory by way of Kansas.

(30)At age 18 Hugh enlisted in Company C of the 1st Nebraska Cavalry on June 15, 1861 and served in Louisiana and Arkansas. He was a prisoner of war for a time during the Civil War. "June to Sept 1864 absent in Nebraska confinement at Little Rock, Ark." (42)"But it was not until the men were paroled in St Louis that their true state was learned. They had marched 300 miles barefoot, over gravel and stones. They were completely destitute, having been robbed by the Rebels of everything they possessed. They were paroled in September; they would receive no pay until November. An urgent appeal was put out in Nebraska: for dishes, stationery, needles, and thread - anything and everything which would help them to rehabilitate themselves. Cash in the amount of \$142.50 was collected in Brownville and sent to the men. A day of fasting was observed by the town with all business houses closed and religious services held at the Presbyterian Church."

(30)He was discharged at Omaha, Nebraska in November of 1864. After his discharge Hugh returned to his father's home in Brownville, Nebraska "and for some time afterward superintended the running of [his father's] steam saw mill" because his father was "unable to perform labour one half of the time".

(43A)In March of 1867 he represented his mother, as "next friend" in a land suit in Auburn, Nebraska (county seat of Nemaha Co, in which Brownville is located). By September of 1867 the family had relocated about 60 miles south, this time on the east bank of the Missouri River, in Andrew County, at a place called "Nodaway Slough."

(39)Hugh married CORDILIA WARD in Andrew County, Missouri on September 9, 1867. Cordilia died at Rulo, Nebraska in November 1868. There were no children.

(43A)During the five years between 1865 and 1870 Hugh hauled freight from the eastern Nebraska border to Denver, Colorado. In the 1870 census for Andrew Co, Mo., his occupation is listed as Engineer.

In early 1875, Hugh signed an affidavit at Lemars, Iowa, relating to his father's pension application. There is no information as to why he was in western Iowa and it is not listed in the military papers as a place of residence subsequent to his discharge.

(43A)By 1875 or 1876 both Hugh and his brother, Samuel M Callen, left western Missouri and moved south eastward. The record is not clear as to the exact state of residence. Hugh was injured in the explosion of a steam saw mill in Tennessee in 1875 (one record says 1876; however, Tennessee is not listed as a place of residence after his military service). His injury was apparently severe, cracking his skull in two places, so that years afterward there was a separation of about a match width between the bone.

In March 1883 he was living on the western Louisiana border, near Texarkana. He signed a release at Shreveport, acknowledging receipt of an inheritance from his mother's estate.

By 1886 or 1887 Hugh was living in Gifford, Arkansas, Hot Springs County, on the eastern side of the state.

On February 16, 1889, at age 46, Hugh married his second wife the widow MALINDA JANE LANDRETH OSBORN. There were no children of this second marriage.

In 1892, at age 50, Hugh applied for a military pension, citing his inability to perform his present occupation of farming due to the sawmill injury and damage to his health from "Swamp fever" contracted during his military service.

In 1906 Hugh applied for an increase in his pension, which was granted. He received \$40 per month at the time of his death.

(43A)Hugh apparently remained in Gifford until his death, which occurred about April 1, 1919. He was 76 years old. No pictures exist of Hugh Torrence Callen, but an affidavit in the military papers describe him at the time of his enlistment at 5'10" tall, light complexion, light hair and blue eyes.

2,15-SAMUEL MILLER CALLEN/ Samuel/ Samuel Callen, Sr
SAMUEL MILLER CALLEN was the second son of Samuel & Eliza Jane (Torrence) Callen, and was born April 15, 1845 in Westmoreland Co, Pa. Samuel, also called Miller, was only 8 years old when his mother died. His father moved the family to Davenport, Iowa shortly afterward, and in November of 1854 his father married again.

(43A)On November 28, 1861, at age 16, Samuel M joined the Civil War and served in the 2nd Kansas Cavalry until January 13, 1865.

(39)On June 20, 1869 Samuel M married SARAH ELLEN BAKER who was born in Arkansas around 1850, she was the daughter of Sarah Baker, a widow in Andrew County, Mo. Sarah (Baker) Callen died October 28, 1876, in Wayne Co, Mo, then the mother of 3 children.

(29)The 1870 Andrew Co, Mo. census show Samuel M Callen living with his father and step-mother, his occupation is listed as sawyer.

(43A)In May 1881 in Paducah Kentucky, Samuel M married MARY WYATT,

who was living in north-western Tennessee.

In the 1890 Special Census of Civil War Veterans, Samuel M is listed in Dyer Co, Tennessee, Post Office Trimble. He continued to live in Tennessee until at least the early 1890's. In 1892 he sold his sawmill and lived in Paducah, Kentucky until his death.

In the 1900 Kentucky Federal Census the family is listed in Paducah, McCracken Co, Kentucky. Samuel's occupation is shown as machinist. Samuel lived at 1946 Bridge Street.

The 1910 Kentucky Federal census shows Samuel M in McCracken Co, occupation saw filer.

(43A-43D) "Following his wife's death Samuel lived with his son Elmer. His granddaughter Mae remembers Samuel in his last years. He had a tattoo of a round saw on one thumb. He bought the granddaughters a set of encyclopedias from a traveling salesman which he paid for out of his pension check. A neighbor boy, J.C. Wilkes, recalls that once a week Samuel would walk from his home to the grocery, about a mile, buy a bag of candy and give it to the neighborhood children. He also recalls that Samuel sat on the porch and chewed tobacco and caused some peril to the children who skated on the walk that went around the house."

(43A) Mary (Wyatt) Callen died on April 3, 1924, Samuel Miller Callen died in February 1930 in Paducah, Kentucky. They are both buried in the Wyatt Cemetery.



SAMUEL MILLER CALLEN

Children of Sarah
2,22 i Jeneva Callen-b May 11, 1870
ii Hugh Filbert Callen-b Sept 10, 1872 d Apr 19, 1874
2,23 iii Edward Dickey Callen-b Nov 29, 1874

Children of Mary

iv Maude May Callen-b Jan 24, 1882 in Tennessee
d Sept 29, 1906 (diphtheria)

2,24 v William Elmer Callen-b Feb 27, 1884

2,16-MARGARET J CALLEN/ Samuel/ Samuel Callen Sr

(29)MARGARET JANE CALLEN was born March 6, 1847, probably in Westmoreland Co, Pa, she was the daughter of Samuel and Eliza Jane (Torrence) Callen. Her mother died when Margaret was around 6 years old. Her father moved the family to Davenport Iowa where he married his second wife in November of 1854.

(39)Margaret married ROBERT D MASTERSON on June 16, 1867. Robert was born in Indiana August 8, 1832, and was a farmer by occupation. The 1880 census for Andrew Co, Mo show Robert and Margaret living next door to her father. (39)In 1912 Margaret was living in Gentry Co, Mo. She died February 26, 1917.

Children

i Samuel Masterson-b ca 1868 in Neb

ii Annie Masterson-b in Neb

iii Nettie E Masterson-b Ap 19, 1868 d Apr 15, 1879
buried in Nodaway Cemetery, Nodaway, Mo

2,17-ROBERT TOWNSEND CALLEN/ Samuel/ Samuel Callen Sr

(43B-43C)ROBERT TOWNSEND CALLEN was born September 2, 1857, in Davenport, Scott Co, Iowa. He was the son of Samuel & Rachel (Townsend) Shoemaker Callen, both parents were born in Penna. Robert was a stock raiser.

He was first married to MARY JANE "MOLLIE" GARNER on October 21, 1879 in Andrew Co, Mo. Mary died when she was 29 years old, December 17, 1893. She is buried in Mt Carmel Cemetery (old Baptist Cemetery, also known as Pittman Cemetery) north of Amazonia, Mo. The quotation on her grave marker reads: "Dear Mollie I miss you much, God be with you till we meet again"

Robert T married his second wife ANNIE B (HATE) SPRINGER on August 5, 1903.

(43B)"He was a farmer and had his own blacksmith shop. He had a variety of fruit trees -- all of good quality fruit; also had a vineyard of some of



ROBERT TOWNSEND CALLEN

the finest grapes which he sold to the winery in St Joseph, Mo. And he had all kinds of berries. He sold the fruit and grapes to the market in St Joseph, besides having for their own use. His hobby was fishing; and he chewed tobacco."

Robert Townsend Callen died September 16, 1931; Annie also died in 1931. Robert is buried in Nodaway, Mo.

Children of Molly

2,25 i Samuel Vance Callen-b Dec 13, 1880
twin 2,26 ii Etta M Callen-b Aug 15, 1883
twin 2,27 iii Georgia Callen-b Aug 15, 1883
2,28 iv Robert Ray Callen-b 1888 in Nodaway, Mo
2,29 v Gleave Callen-b May 8 1891

2,18-JOSEPHINE CALLEN/ Samuel/ Samuel Callen Sr
(43B)JOSEPHINE CALLEN was born March 13, 1860 in Brownsville, Nebraska, the daughter of Samuel and Rachel (Townsend) Shoemaker Callen. She married on June 21, 1886 to A.H. BUSCHMAN.

Children

(may be partial list)

i Lewis C Buschman-b ca 1888 d Aug 4, 1892 Nodaway Cem
ii Lula May Buschman-b Aug 1894 d Oct 31 1895 Nodaway

2,19-SIMON LUTHER CALLEN/ Samuel/ Samuel Callen Sr
(43B)SIMON LUTHER CALLEN, called Luther, was born September 30, 1869, the son of Samuel and Rachel (Townsend) Shoemaker Callen. He married ROSA C OTT on January 7, 1897 in Savannah, Andrew Co, Mo. Rosa died April 26, 1905 and is buried in Nodaway, Mo; Luther died November 18, 1954 in Seattle, Washington.

2,20-ANNA R CALLEN/ Samuel/ Samuel Callen Sr
(43B)ANNA R CALLEN (called "Annie") was born February 15, 1873 in Nodaway, Andrew Co, Mo. She married JOHN SCHENK. Annie died October 23, 1895 and is buried in the Nodaway Cemetery.

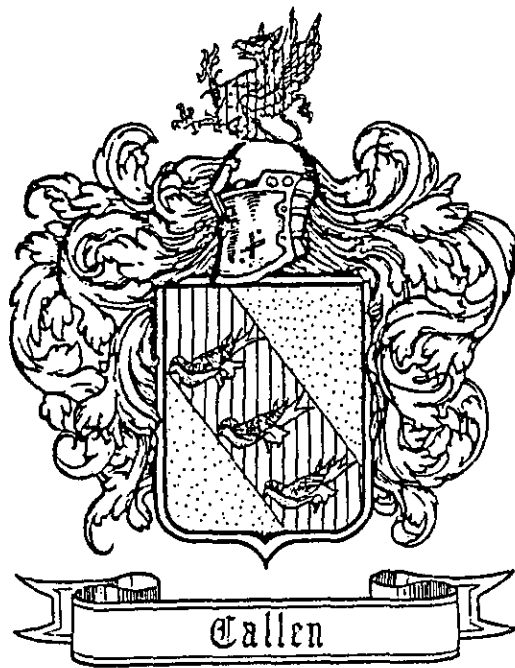

LINE OF SAMUEL CALLEN, SR - 4TH GENERATION

2,21-ADA MAY McBRAYER/ Sarah Callen/ Matthew Samuel Callen Sr
(40)ADA MAY McBRAYAR (McBrayer) was the daughter of Sarah Jane (Callen) and Dr William McBryar. "She married Doctor JOHN M ST.CLAIR. John had three children by a previous marriage. John and Ada resided in Indiana Boro, Indiana Co, Pa, where he had his practice."

Children

S/D Blanche St Clair-b
S/S Paul St Clair-b
S/S John St Clair-b
i William McBryar St Clair-b
ii Mary Alice St Clair-b
iii Fred Callen St Clair-b
iv Robert Allen St Clair-b
v Lisle Porter St Clair-b

2,22-JENEVA CALLEN/ Samuel M/ Samuel/ Samuel Callen Sr
(43A)JENEVA CALLEN was born May 1870 in Armstrong Co, Mo, she was the daughter of Samuel Miller Callen and Sarah Ellen (Baker) Callen. Her mother died when Geneva was only 6 years old. By 1880 Geneva had been taken or sent back to Pennsylvania.

She lived with her great uncle and aunt George A and Hannah (Torrance) Greer, of Westmoreland Co, Pa. Hannah was the sister of Eliza Jane (Torrance) Callen who was the natural grandmother of Geneva. Geneva married MR. RODGERS (or ROGERS).

Had 3 children

2,23-EDWARD D CALLEN/ Samuel M/ Samuel/ Samuel Callen Sr
(43A)"EDWARD DICKEY CALLEN was born November 29, 1874, in Wayne Co, Mo., in the village of Crossroads, he was the son of Samuel Miller Callen and Sarah Ellen (Baker) Callen. His mother died when Edward was only 23 months old. By 1880 he had been taken or sent back to Pennsylvania.

"The 1880 census shows Edward living with his great uncle and great aunt John M and Margaret (Callen) Dickey, in Westmoreland Co, Pa. He is listed in John Dickey's will in 1886 as a member of the household.

"His early education was in a one-room school house. In his later years he spoke of going to school early to light the fire and how bitterly cold the Pennsylvania winters were. He completed his education in Pennsylvania and worked for the Homestead Steel Mill. At age 17 he went to Paducah, Kentucky and rejoined his father and his step-mother, Mary (Wyatt) Callen. In the 1900 census Edward is listed as a member of his father's household and his occupation is shown as day laborer.

"His father sold him a house and lot in Paducah, Kentucky prior to his marriage, which he sold when he "went on the river".



the GEO. POPE

"Edward Dickey Callen married in 1903 and during the period 1904 to around 1910 he worked on a small steam boat called the 'Geo. Pope' and barged logs down the White River in eastern Arkansas. His wife, Lillie, cooked for the boat's crew for a time. He was a licensed Marine Engineer and renewed his license until he was 70 years old, at which time his license became permanent.

"By 1910 Edward was living in Vicksburg, Mississippi, with his

wife LILLIE ALICE COLE and two sons. His occupation was Steam Engineer, employed by a gravel company. During his employment with the gravel company he perfected methods for dredging and recovering sand by barge, several of which processes were subsequently patented. He devised a bucket mechanism that was later perfected by a road builder and used in ditch digging. Later in his career he was employed by Dutton's Foundry as a pattern maker and specialized in sand cast molds. During the depression and after he had retired he taught for the Army Corp of Engineers (CCC) training young men to operate heavy equipment in the National Military Park in Vicksburg.

"He had a small business from his home sharpening saws. He kept bees, engaged in woodworking, and continued to pursue his inventions, including development of a fire bomb during WWII. It was sent to Washington, but returned by the government, saying it was too complicated for mass production.

"Throughout his life, he maintained a curiosity about how things work and is well remembered by his family for the many hours spent in his basement workshop. Except for meals he spent most of every day in his shop which was right beneath the kitchen. He was almost totally deaf by then and couldn't hear anyone calling from upstairs. When Lillie wanted him for meals she would bang on the kitchen floor with a broom handle.

"Several pieces of his furniture and at least one of the working models he submitted with his patent applications survive.

E. D. CALLEN.
 EXCAVATOR.
 APPLICATION FILED SEPT. 4, 1918.

1,342,895.

Patented June 8, 1920.
 2 SHEETS—SHEET 1.

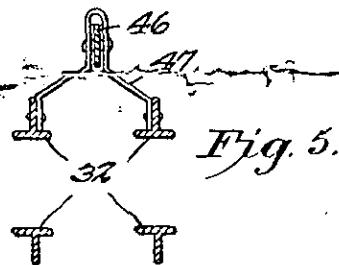
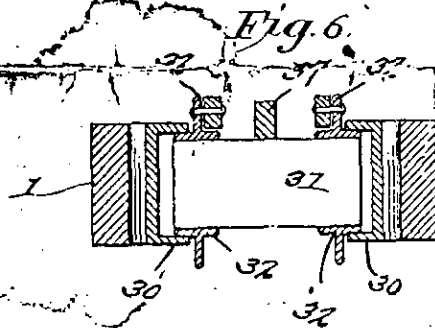
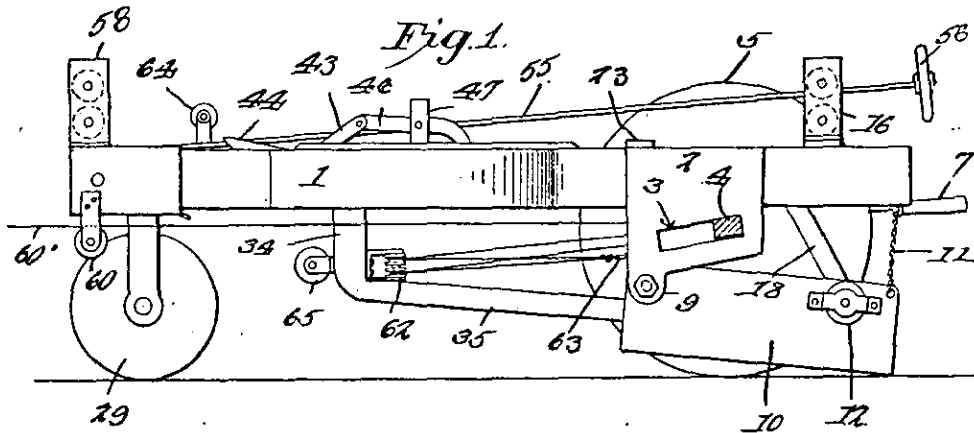
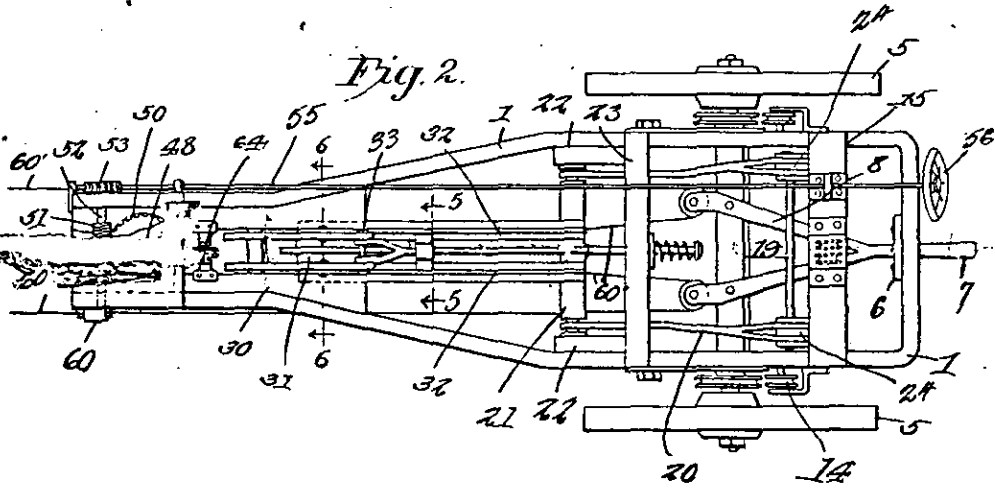

Witness

J. P. [Signature]

Inventor

E. D. Callen

By *Callen & Co.*
 Attorneys

Edward died March 14, 1954 in Vicksburg, Mississippi."

Children

- 2,30 i Edward Miller Callen-b Apr 18, 1904
- 2,31 ii Paul Cole Callen-b Nov 3, 1908
- 2,32 iii William Torrance Callen-b May 4, 1915
- 2,33 iv Kenneth Elmer Callen-b Apr 12, 1917
- 2,34 v Raymond Francis Callen-b Apr 4, 1919

2,24-WILLIAM E CALLEN/ Samuel M/ Samuel/ Samuel Callen Sr

(43A)WILLIAM ELMER CALLEN was born February 27, 1884 in Paducah, McCracken Co, Kentucky, the son of Samuel Miller Callen and 2nd wife Mary (Wyatt) Callen. On June 20, 1917 in Paducah, McCracken Co, Ky, he married EVA STAR MAGDALENE DICKEY who was the daughter of John Andrew and Mamye Magdalene (Powley) Dickey.

His daughter Mae writes (43D)"Dad was a very shy, kind, quiet and generous man--sometimes to a fault. He worked all of his life as a first class carpenter and cabinet maker. For many years he worked for J.W. Lockwood and Son Contracting Co., and did work in and on major Paducah business establishments and homes, including Vice President Alben Barkley's Paducah home.

"He built our home on the Husbands Road in 1923. It was a two story four bedroom brick house on four acres. He did all of the work except the brick work. In his spare time he divided the home on Bridge Street into two parts and moved them back on the lot to make two small houses. He then added a gasoline station on the space where the house had been. He later built three very small (three room) houses on the additional space. All of these buildings were in the 1937 flood and had to be repaired after the flood.

"Additionally, the 1937 flood water reached seven foot in our home on the Husbands Road. We went to bed one night in January with no water in the yard and the next morning we could not get out in knee boots and in about three or four hours the water was in our home. The previous night we had purchased a lot of food, oil, etc which Mother had insisted on as she seemed to know it was the thing to do. Evelyn and I left from an upstairs window and spent six weeks with friends out of the flood area. Mother, Dad and Margaret remained upstairs throughout the flood. Dad made a boat from parts of built-in furniture and benches and was able to check on other homes nearby. Another couple moved in with them, sharing food, etc. Most of our downstairs furniture was destroyed, but I guess we were better off than most families.

"In later years Dad worked for the Tennessee Valley Authority (TVA) doing carpentry work at the Kentucky State Dam at Gilbertsville, Ky., about 28 miles from Paducah.

"Dad retired at, I believe, age 65. He then built and sold two houses next to our home on the Husbands Road. He said that he had been too active all of his life to abruptly quit working. He would work on the houses in the mornings and rest in the afternoon. He belonged to the Carpenters Union most of his life.

"In his young years he enjoyed ice skating and playing football (Checkers & Whisks teams). He had one of the earlier cars--at least back as far as 1917 when he was married.

"All of his life he was interested in football, baseball, softball and basketball. Sometimes he would watch one game on TV and have one on radio at the same time. Not having any male children we girls and/or Mother were often taken to ball games. When I was 14 years old (1932) Dad and Mother got out the encyclopedia and determined dimensions and made a tennis court next to our home. We and our friends and relatives really enjoyed having the court."

(43A)William died April 10, 1968, and Eva died March 10, 1950, both are buried in the Mt Kenyon Cemetery in Paducah, Ky.

Children

(all born in Paducah, McCracken Co, Ky)

- 2,35 i Mae Magdalene Callen-b Jun 11, 1918
- 2,36 ii Evelyn Frances Callen-b Jun 13, 1921
- 2,37 iii Margaret Ann Callen-b Aug 17, 1925

2,25-SAMUEL V CALLEN/ Robert T/ Samuel/ Samuel Callen, Sr

(43B-43C)SAMUEL VANCE CALLEN was born December 13, 1880, in Nodaway, Missouri, he was the son of Robert T and Molly (Garner) Callen. By occupation he was a farmer. On April 18, 1900 Samuel married OLLIE MAE "BELLE" KIRBY. The wedding was at her father's home. She was born May 6, 1880 in Doniphan Co, Kansas. Belle was the daughter of John "Jack" and Elizabeth Jane (Morrsey) Kirby.



OLLIE & SAMUEL V CALLEN

(43C)Samuel loved horses. He broke wild horses and mules and trained them. He trained some of his horses to do tricks; and he did trick riding and roping. He would ride his favorite horse "Tony" in parades. His hobby was collecting miniature horses, he had two china closets full of them.

(43B)"They had cattle, horses, mules and pigs; and he was particular with his animals to see that they were properly cared for, fed and watered. Sam liked to play the violin -- playing fiddle music and played with some fellows for dances."

The family lived in Kansas, California, and Nodaway, Missouri. Samuel V died February 18, 1963 in Nodaway, Mo; Ollie died March 14, 1957 in St Joseph, Mo; both are buried in the Fillmore Cemetery.

Children

- i Lee Callen-b Jan 1901 died at birth
- 2,38 ii Torrance Henry Callen- b Sep 2, 1902
- 2,39 iii Mary Elizabeth Callen- b Jan 2, 1904
- 2,40 iv Endil Otis "Peggy" Callen- b Apr 11, 1905
- 2,41 v Robert Vance Callen-b Aug 23, 1906
- 2,42 vi Eden Rush Callen-b Jan 16, 1908
- 2,43 vii Hemet Clarence Callen-b Apr 14, 1910
- 2.44 viii Vada Lucille Callen-b Mar 4, 1912
- 2,45 ix Cody Leslie Callen- b Sep 20, 1915
- twin x boy Callen-b 1917 died at birth
- twin xi girl Callen-b 1917 died at birth
- 2.46 xii Venice Vernon Callen-b Aug 21, 1918
- 2,47 xiii Vester Kenneth Callen-b Feb 22, 1920
- 2,48 xiv Chester Gleavie Callen-b Jan 5, 1922



March 1946 - GLEAVIE, KENNY, VENICE, VADA, HEMET, ROBERT V, MARY, OLLIE & SAMUEL V CALLEN

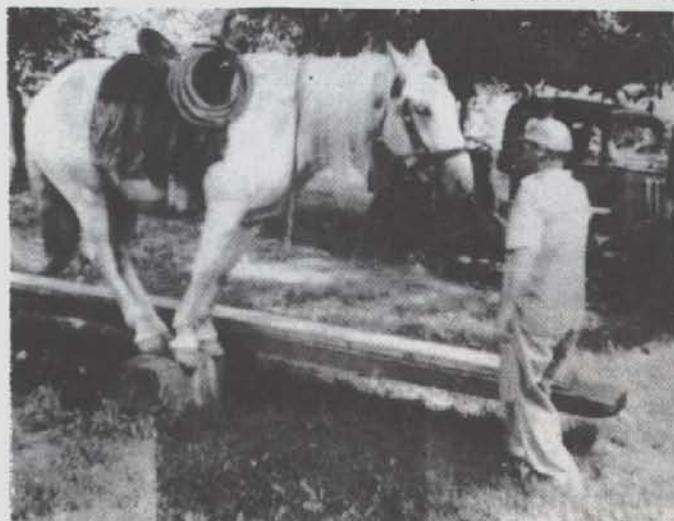

TONY & SAMUEL V



PAINTING OF TONY IN CALLEN BARN

2,26-ETTA M CALLEN/ Robert T/ Samuel/ Samuel Callen Sr
(43C)ETTA M CALLEN was born August 15, 1883, she was a twin daughter of Robert T and Mollie (Garner) Callen. Etta was born in Doniphan Co, Kansas. On September 3, 1902 she married ALBERT L WALLACE. She died one year later, October 22, 1903, of consumption, leaving an infant son. She is buried in Pollock Cemetery, south of Oregon, Mo.

2,27-GEORGIA CALLEN/ Robert T/ Samuel/ Samuel Callen Sr
(43C)GEORGIA CALLEN was born August 15, 1883, she was a twin daughter of Robert T and Mollie (Garner) Callen. She was born in Doniphan Co, Kansas. Georgia also called "Georgie" married OSCAR GOODLOE. She died on June 25, 1905 and is buried in the Nodaway Cemetery, Nodaway, Mo.

2,28-ROBERT R CALLEN/ Robert T/ Samuel/ Samuel Callen Sr
(43C)ROBERT RAY CALLEN was born March 22, 1888 in Nodaway, Mo, son of Robert Townsend and Molly (Garner) Callen. He married BLANCHE MARIE JENKIN on August 15, 1912. Blanche was born on May 18, 1895 the daughter of Jess and Eva (Patterson) Jenkin.

Robert was a farmer, Blanche was a housewife. They were Methodist in religion.

Robert died on April 9, 1961, his wife died just a few months later on September 1, 1961. They are buried in the Savannah Cemetery.

Children

- 2,49 i Jessie Dale Callen-b Apr 29, 1915
- 2,50 ii Kenneth "Lee" Callen-b July 14, 1916
- 2,51 iii George Francis Callen-b Aug 2, 1921



KENNETH, JESSE, BLANCHE, ROBERT, GEORGE,
and his son GEORGE RAYMOND.

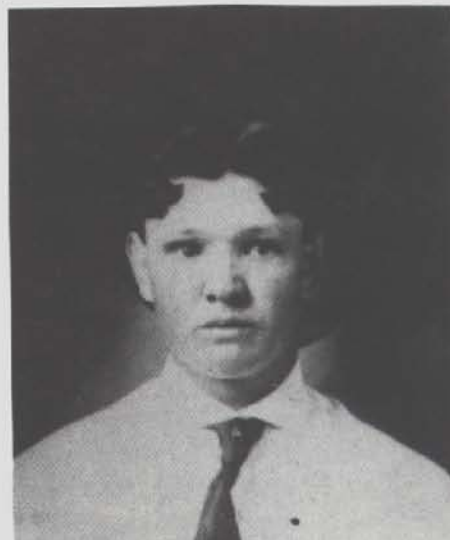

ROBERT RAY CALLEN

2,29-**GLEAVE CALLEN/ Robert T/ Samuel/ Samuel Callen Sr**
(43B-43C)**GLEAVE CALLEN** was born May 8, 1891, the son of Robert T and Molly (Garner) Callen. Gleave was named for Dr. Gleave who was the family physician. He remained a bachelor. Gleave died February 13, 1928.

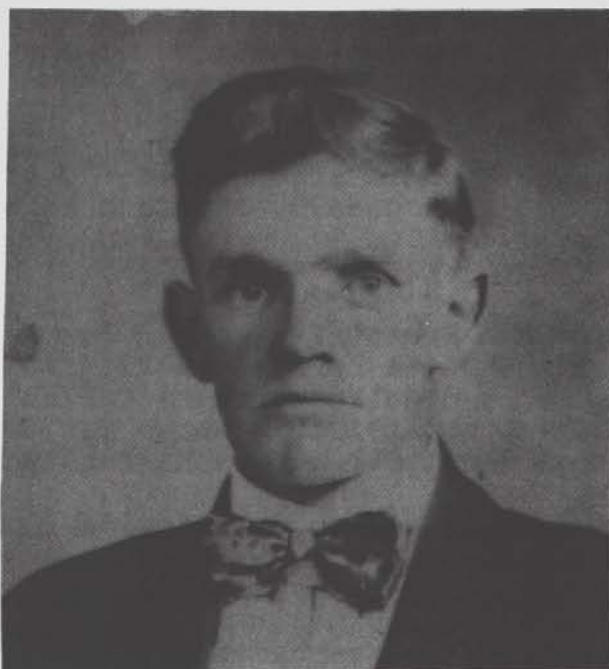

GLEAVE CALLEN

LINE OF SAMUEL CALLEN SR - 5TH GENERATION

2,30-EDWARD M CALLEN/ Edward D/ Samuel M/ Samuel/ Samuel Callen Sr
(43A)EDWARD MILLER CALLEN was born April 18, 1904, in Augusta,
Woodruff Co, Arkansas. He was the son of Edward Dickey and Lillie
(Cole) Callen.

(43E)"He spent many summers near Mt. Vernon and New Harmony Ind.
with his Mother's two brothers Dick (Richard) Cole and Will Cole.
They lived near each other and were farmers.

"Edward made the first trip by train when he was about 6 years old.
They came seven miles by horse & buggy to pick him up. Once the
arrival time was incorrect. He walked the seven miles alone and at
night. He went up there almost every summer until he was 15 or 16.
There were seven cousins, counting Edward. They formed a life long
friendship and were always a joy for each other...

"His grandmother Naomi Green Cole lived with Uncle Will sometimes,
but mostly with Uncle Dick...Edward spoke of helping her with the
washing, carrying water & baskets of clothes. She did most of the
mending for the family. The children in those days, at least there,
slept on mattresses or 'ticks' filled with dried corn husks. When
the farm chores were less demanding she would get Edward, Charlie, &
Oscar to bring in the corn husk and refill the ticks. In winter
there were beds, but in summer the boys slept on the porch that went
around 3 sides of the house. After the noon meal all the men & boys
took a nap on the porch, 'To let the horses rest'!

"Edward talked of traveling with his Mother on the Packet Boats,
where to or when I don't know. The family moved to Vicksburg, from
Greenville, Miss when he was about 15. He came down river by
himself and found the house at 914 DeWitt. He never said, but
probably rented it to begin with.

"In those years there were men who made their living by harvesting
wheat. They owned the necessary equipment for this operation. Wheat
harvest usually started in Texas, moving north and east as needed.
The summer he was seventeen [Edward] went, by train, to Texas and
hired on a harvesting crew, going north and east to Hutchinson,
Kansas. There he took typhoid fever and had to go home.

"He told of going into a men's clothing store in Hutchinson in his
only pair of overalls and a ragged shirt. He was so lanky at that
time and I expect his hair was rather unruly, being so thick. He
always loved good cloths. As he picked out a good suit and other
things the clerk seemed nervous. When Edward took a large roll of
bills from his pocket the clerk nearly fainted. This is the way he
told me about it.

"He had only three years of high school, but always studied. He
took courses with the International Correspondance Institution as a
young man, in Steam Engineering. Later he went to night classes at
the University of Colorado taking drafting and Steam Engineering.

"When he was eighteen he went to work for the City Light and Power Company as turbine operator in Vicksburg, Miss. He worked there until he went to Colorado...[the plant] wasn't too far from 914 DeWitt St. He said he ran all the way home when that house burned.

"He went to Denver, Colorado in 1923-4. He lived there less than a year. He had a job with The Sterns-Rogers Construction Co...then he was hired by what is now the Public Service Co of Colo, going to work at Valmont Plant as turbin operator in Nov 1924.

(43A) On September 27, 1926 he married BEULAH FLORENCE CAMPBELL, who was born Oct 2, 1905. She is the daughter of John Franklin and Maude (Buckhorn) Campbell..

(43E)"In 1952 he was transfered to the Denver office as Superintendant of Outside Steam Plants. The plants were...in Boulder, Alamas, Stereling, [and] Grand Junction, all in Colorado; and Cheyene, Wyo. He worked for 'the company' from Nov 1924 to May 1st, 1966. Fourty two years. I think he loved every minute of it.

"He was a very quite, peaceful man. Faithful and true in all things.

"He was a member of The Boulder Fish & Game Club. Mostly they stocked high mountain lakes with rainbow trout, within 20 or 30 miles of Boulder. They carried about fifty pounds of fish and water in five gallon square tin containers in their back packs. It was necessary to stop at streams along the way to change the water so there would be enough oxygen for the fish. They drove as far as they could then walked several miles to the lakes.

"Edward preferred fishing in the high mountain lakes. He often drove 40 or 50 miles then hiked 6 to 10 miles to favorite lakes at altitudes of 8,000 to 10,000 feet. There was a group of 8 to 10 men who did this, usually only 2 or 3 at a time. He never went alone...

"As a family we did a lot of camping and back packing. Often sleeping in the open. Virginia was 5 and Suzanne 8 on our first back packing trip. They had their own little soft back packs for extra clothing, staying out two or three nights.

Edward went over near Grand Junction Colorado many years for deer hunting, taking his family to visit with his wife's childhood friends."

Edward Miller Callen died June 16, 1973 and is buried in Littleton, Jefferson Co, Colorado.

Children

- i Suzanne Marie Callen-b Sept 16, 1930
m Mar 18, 1950 to RICHARD E HARGIS
- ii Virginia May Callen-b Jul 26, 1933
m Dec 28, 1951 to RONALD L GREENO

2,31-PAUL C CALLEN/ Edward D/ Samuel M/ Samuel/ Samuel Callen Sr
(43G)PAUL COLE CALLEN was born November 3, 1908, and was raised in the area of Vicksburg, Mississippi. On April 16, 1929, he married CARRIE CHRISTINE NELSON, who was born March 30, 1908, the daughter of Carl A and Mary E (Iler) Nelson. After his marriage his family moved to Denver Colorado, later returning to Vicksburg where Paul worked as a welder for a barge terminal.

During World War II Paul worked at a shipyard near Mobile, Alabama and later for Chicago Bridge and Iron Co. where he worked on large water towers. He retired from Alcoe Aluminum Co and he and his wife live in Chicasaw, Alabama, near the Gulf of Mexico. Both enjoy fishing.

Children

- i Mary Elizabeth Callen-b Aug 25, 1930 d Dec 23, 1988
m Sept 20, 1948 to STANLEY R POKORNE
- ii Mildred Alice Callen-b Aug 29, 1935
m Jul 7, 1956 to WILLIAM E GRAYSON
- 2,52 iii Edward Dickey Callen-b Oct 29, 1939

2,32-WILLIAM T CALLEN/ Edward D/Samuel M/ Samuel/ Samuel Callen Sr
(43A-43F)WILLIAM TORRANCE CALLEN was born May 4, 1915. He was raised in the Vicksburg, Mississippi area. He married CATHERINE LUDKE. He trained as a welder and worked as a boilermaker in the shipyards in Mobile, Alabama during WWII. He later worked as a boilermaker in construction in southern Texas and Louisiana and retired to the Freeport, Texas area. William and his second wife, LATRELLE, live at Surfside, Texas, near the Gulf of Mexico and he enjoys fishing.

Children

- i Frederick Torrance Callen-b July 16, 1942
Vicksburg, Miss. bachelor
- ii John Ludke Callen-b July 24, 1943
m Jul 4, 1962 to WANDA DAMPIER
- iii George Wayne Callen-b Aug 25, 1944
m May 20, 1967 to JEAN BREEDLOVE
- iv Bobbie Donald Callen-b Nov 6, 1945 in Mobile, Ala
m Feb 24, 1973 to SHERRY REED

2,33-KENNETH E CALLEN/ Edward D/ Samuel M/Samuel/ Samuel Callen Sr
(43A)"KENNETH ELMER CALLEN was born April 12, 1917 in Greenville, Mississippi. His family moved to Vicksburg when he was 3 years old and he grew up in a house that was built on one of the sites on which the Battle of Vicksburg had been fought. The family retains several items recovered in the area of the home. including an ornate saber. Kenneth attained the rank of Eagle Scout and was a member of the Sea Scouts. In high school he participated in sports and earned a letter in track.

On September 11, 1937 he married MARY EDNA THOMAS who was born in Hissop, Alabama on March 14, 1914, the daughter of Lawrence O and Cora B (Hughes) Thomas.

"Kenneth apprenticed as a welder and subsequently worked on dam construction projects in Mississippi until shortly before the start of WWII. From 1941 to 1945 he was employed by a shipyard near Mobile, Alabama, which constructed destroyers, minesweepers and cargo ships.

"In 1951 the family relocated to Lake Jackson, Texas, near Houston. He retired in 1975 from a position as maintenance supervisor with a major chemical company. He and his wife reside in Angleton, Texas. They spend time between their home and a travel trailer which is parked on a private reservoir. They enjoy traveling, fishing and share an interest in wildlife. Kenneth builds multi-story wood and aluminum Martin houses for friends in the area and has developed a process of using water pressure to lower and raise the heavy houses.

Child

2,53 1 Dorothy Belle Callen-b Oct 23, 1942

2,34-RAYMOND F CALLEN/ Edward D/ Samuel M/ Samuel/Samuel Callen Sr (43A)RAYMOND FRANCIS CALLEN was born April 4, 1919 in Greenville, Mississippi, the son of Lillie Alice (Cole) and Edward Dickey Callen. "When he was 1 year old the family returned to Vicksburg, moving to 914 DeWitt. Except for a brief stay in Alabama, at which time he worked in the shipyard, he lived in the homeplace until his death. He remained a bachelor and took care of his parents as long as they lived.

"Raymond was employed by The River Commission until an accident almost took his life. When he recovered he was employed by his church as custodian and served it well. In his eulogy, the minister said Raymond was happiest when he was helping others.

He died on January 18, 1983 and is buried in the Cedar Hill Cemetery, Vicksburg, Ms.

2,35-MAE M CALLEN/ William E/ Samuel M/ Samuel/ Samuel Callen Sr (43D)MAE MAGDALENE CALLEN was born June 11, 1918 in Paducah, McCracken Co, Kentucky. She is the first daughter of Wm Elmer and Eva (Dickey) Callen.

"Mae graduated from Reidland High School, Paducah, Ky. in 1936. She attended Draughon's Business College in Paducah, Ky.

"In 1939 she accepted a position with the Aero Medical Research Laboratory, Wright Patterson Air Force Base, Dayton, Ohio, as secretary and later as administrative assistant.

"In 1951 she transferred to the Civilian Personnel Office of the newly established Aeronautical Systems Division of the Air Force Systems Command at Wright Patterson Air Force Base. She worked here

as Personnel Specialist in the area of Placement and Employee Relations and Salary and Wage Classifier until early retirement in 1973.

On June 25, 1955 "Mae married PETER POSZYWAK of Lorain, Ohio who also worked at the Aeronautical Systems Division as a General Investigator.

"Peter Poszywak died in November 1966 after surgery for a malignant brain tumor. There were no children from this marriage. Mae Magdalene Callen Poszywak now resides in Centerville, Ohio."

2,36-EVELYN F CALLEN/ William E/ Samuel M/ Samuel/Samuel Callen Sr
(43A)EVELYN FRANCES CALLEN was born June 13, 1921 in Paducah, McCracken Co, Kentucky. She is the middle daughter of Wm Elmer and Eva (Dickey) Callen.

"Evelyn graduated from Reidland High School, Paducah, Kentucky in 1939; thereafter she attended Draughon's Business College in Paducah, Ky. At the outbreak of World War II she accepted work as a stenographer at Wright Patterson Air Force Base, Dayton, Ohio where she met and married [on July 18, 1942] CHARLES GILBERT DIMETRAL of Cincinnati, Ohio. During the war era she had seven tours of duty with Federal Civil Service. After the war they moved to California, as Gilbert had been accepted to matriculate at Pepperdine University to persue a masters degree.

"In California two daughters were born (Ixchel and Diana Lynn).

"Charles Gilbert Dimetral died in July 1967 while mountain climbing with a class on Mt. Laughlin, Oregon. He was pursuing a doctorate degree in earth sciences.

"Evelyn Frances (Callen) Dimetral was employed by NASA for 28 years as an Administrative Assistant. She is now retired and resides in Pasadena, California."

Children

2,54 i Ixchel Star Dimetral-b 1949
2,55 ii Diana Lynn Dimetral-b 1951

2,37-MARGARET A CALLEN/ William E/ Samuel M/ Samuel/ Samuel Callen Sr
(43A)MARGARET ANN CALLEN was born August 17, 1925. She is the third daughter of Wm Elmer and Eve (Dickey) Callen.

"Margaret graduated from Reidland High School, Paducah, Ky in 1943. She attended Paducah Junior College, obtaining an associate degree. After college she worked as a teller at Peoples First National Bank, Paducah, Ky.

"In 1964 she accepted a position in communications with the Department of State, Washington, D.C. She had Foreign Service tours in New Delhi, India; Vienna, Austria; Santiago, Chili; Madrid,

Spain; Seoul, Korea; London, England; Paris, France; Kinshasa, Zaire; and Rome, Italy.

"Margaret retired in December 1984. Margaret did not marry, She resides in Centerville, Ohio."

2,38-TORRANCE CALLEN/ Samuel V/ Robert T/ Samuel/ Samuel Callen Sr

(43C)TORRANCE LUTHER "TARZ HENRY" CALLEN was born on September 2, 1902 in Nodaway, Andrew Co, Mo, he was the son of Samuel V. and Ollie (Kirby) Callen. In June 1922, in St Joseph, Mo, he married HELEN NIGEL TAYLOR. Tarz died in February 1981 and is buried in the Fillmore Cemetery, Fillmore, Missouri.

Children (May be partial list)

i Lloyd Leo Callen-b Nov 6, 1923 "was in the U.S. Navy with his duty being in the South Pacific in WWII. (He spent 12 or 16 years in the U.S. Navy)"

2,39-MARY E CALLEN/ Samuel V/ Robert T/ Samuel/ Samuel Callen Sr

(43C)MARY ELIZABETH CALLEN was born January 2, 1904 in Oregon, Holt Co, Mo, she was the daughter of Samuel V. and Ollie M (Kirby) Callen. On January 30, 1924 she married GEORGE WASHINGTON ATHERTON. George died October 23, 1983 in Atchison Co, Mo. Mary is living in Atchison.

2,40-ENDIL O CALLEN/ Samuel V/ Robert T/ Samuel/ Samuel Callen Sr

(43C)ENDIL OTIS "PEGGY" CALLEN was born on April 11, 1905 in Amazonia, Missouri. She is the daughter of Samuel V and Ollie M (Kirby) Callen. On November 19, 1925 she married ROBERT GOFF JR. Robert died on March 5, 1955 and is buried in Sunset Pines, California. Peggy lives in California.

2,41-ROBERT V CALLEN/ Samuel V/ Robert T/ Samuel/ Samuel Callen Sr



(43C)ROBERT VANCE "BOB" CALLEN was born on August 23, 1906 in Nodaway, Andrew Co, Mo. He was the son of Samuel Vance and Ollie M (Kirby) Callen. On August 25, 1940 in St Joseph, Mo he married ELIZABETH LITTLES.

(43B)"Robert Vance Callen was in the U.S. Army in WWII with his service duty in France as heavy equipment operator. He died September 16, 1979 in Forsyth, Mo and is buried in Springfield Green National Cemetery."

ELIZABETH & ROBERT V CALLEN

2,42-EDEN R CALLEN/ Samuel V/ Robert T/ Samuel/ Samuel Callen Sr
(43J)EDEN RUSH CALLEN was born on January 16, 1908 in Nodaway, Mo.
He was the son of Samuel V and Ollie M (Kirby) Callen. On August 3,
1928 in St Joseph, Mo he married VERNELLE D DONALDSON. Vernelle was
born February 4, 1912 in Easton, Buchanan Co, Missouri. Eden was a
farmer, and Vernelle worked and retired from the St Joseph State
Hospital.

Eden died on July 11, 1939 in Nodaway, and is buried in the Fillmore
Cemetery in Fillmore, Mo; Vernelle died on December 4, 1986 and is
buried in Blakeley Cemetery in Easton, Mo.

Children

- i Wyman Joseph Callen-b July 11, 1929 d Sept 1, 1929
- ii Doris June Callen-b June 12, 1930 m Mr. TAYSEN
- 2,56 iii Wilbur Dean Callen-b Nov 28, 1937

2,43-HEMET C CALLEN/ Samuel V/ Robert T/ Samuel/ Samuel Callen Sr
(43C)HEMET CLARENCE CALLEN was born on April 14, 1910 in Hemet,
Los Angeles Co, California. He was the son of Samuel V and Ollie M
(Kirby) Callen. Hemet married EVA MAE L BIVENS. He died on
December 14, 1972 when crushed by a machine at a rock quarry in Ft
Calhoun, Nebraska. He is buried in the Fillmore Cemetery, Fillmore,
Mo.

2,44-VADA L CALLEN/ Samuel V/ Robert T/ Samuel/ Samuel Callen Sr
(43C)VADA LUCILLE CALLEN was born on March 4, 1912 in Wilmington,
Los Angeles Co, California. On July 31, 1933 in Rockport, Mo, she
married HERMAN CURTIS BAKER. Herman died on April 23, 1975 and is
buried in the Fillmore Cemetery, Fillmore, Mo. Vada is living in St
Joseph, Mo.

Children

- i Leslie Eugene Baker-b July 5, 1934 "was in the U.S.
Army with duty in Germany"

2,45-CODY L CALLEN/ Samuel V/ Robert T/ Samuel/ Samuel Callen Sr
(43I)CODY LESLIE CALLEN was born in Nodaway, Mo on September 20,
1915, the son of Samuel V and Ollie Mae (Kirby) Callen. On July 2,
1939 in St. Joseph, Missouri he married HELEN PAULINE HOWARD who was
born on August 12, 1916 in Amazonia, Missouri. Cody was a welder
and Helen was a housewife. They are living in Lafayette, Georgia.

Only Child

- 2,57 i Christena Mae Callen-b May 28, 1939

2,46-VENICE V CALLEN/ Samuel V/ Robert T/ Samuel/ Samuel Callen Sr
(43C)VENICE VERNON CALLEN was born on August 21, 1918 in Nodaway,
Andrew Co, Mo. He was the son of Samuel V and Ollie M (Kirby)
Callen. He never married. He died on October 22, 1946 in Nodaway,
and is buried in the Fillmore Cemetery, in Fillmore, Mo.

2,47-KENNETH CALLEN/ Samuel V/ Robert T/ Samuel/ Samuel Callen Sr
 (43B) VESTER "KENNETH" CALLEN



(called Ken or Cal) was born February 22, 1920, in Oregon, Mo. He is a retired Electrician and Electrical Lineman. In 1942 in Santa Monica, California he married GLADYS AGNES PIEPER, who is a co-researcher and compiler of this book. They are presently living in Fort Morgan, Colorado, and love fishing and traveling.

Ken was in the U.S. Navy in the South Pacific in WWII for 3 1/2 years. His duty was on an attack transport (the U.S.S. Doyen) and he was in 8 invasions of Islands. In the 1950's he was in the U.S. Army Reserves for 7 years.

GLADYS & KEN (wedding photo)

Children

- 2,58 i Mary Ann Callen-b Sept 13, 1946
- 2,59 ii Melvin Kenneth Callen-b Sept 28, 1947
- 2,60 iii Vernon Hugh Callen-b Sept 7, 1950
- 2,61 iv Robert Vance Callen-b Oct 7, 1952
- 2,62 v Rodney James Callen-b Nov 30, 1953

2,48-CHESTER G CALLEN/ Samuel V/ Robert T/ Samuel/Samuel Callen Sr
 (43C) CHESTER GLEAVIE "CHET" CALLEN was born January 5, 1922 in Oregon, Holt Co, Mo. On May 20, 1945 he married MARY RUTH DAHLMAN in St Joseph, Mo. Mary was born November 11, 1925 and she died March 9, 1988. (43B) Chet was in the U.S. Navy in WWII in the Signal Corp. He had duty in the South Pacific and Panama Canal Zone.

2,49-JESSIE D CALLEN/ Robert R/ Robert T/ Samuel/ Samuel Callen Sr
 (43C) JESSIE DALE CALLEN was born April



ANNIE & JESSIE CALLEN

29, 1915 in Nodaway, Missouri, he is the son of Robert R and Blanche (Jenkin) Callen. He married ANNIE MILLER who was born on February 13, 1916. They have no children.

2,50-KENNETH L CALLEN/ Robert R/
 Robert T/ Samuel/ Samuel Callen Sr
 (43C) KENNETH LEE CALLEN was born July 14, 1916, in Nodaway, Mo. He married MARLYS MAGNUS on December 9, 1945, she was born August 22, 1922.

He owned and operated the Callen Well Driving Co for over 35 years. He was a veteran of World War II and a member of the Foreign Wars Post WO 4690, and the American Legion Post WO 40 in Webster South Dakota.

Kenneth died on November 27, 1988 and is buried in the Webster Cemetery in Webster, South Dakota.

Child

i Paulette Marie Callen-b July 24, 1947
m Mr. MUTLEY divorced in 1971

2,51-G FRANCIS CALLEN/ Robert R/ Robert T/ Samuel/ Samuel Callen Sr

GEORGE FRANCIS CALLEN (43C)"was born August 2, 1921 in [the] same log house in which his father was born in 1888. On February 21, 1942, he married GEORGIA ROSE KING." Georgia was born October 18, 1922 in St Joseph, Missouri, she has helped with information on this family line and supplied many of the pictures.

Francis was a dough mixer and worked for Wonder Bakery. He also was a farmer, and served as Mayor of Amazonia, Missouri. He was a veteran of World War II (43B)with duty in Europe. He was a life member of the Disabled American Veterans.

He died on April 7, 1989, and is buried in Mt. Auburn Cemetery.

Children

2,63 i George Raymond Callen-b Feb 17, 1944
2,64 ii Robert Lee Callen-b June 15, 1952
2,65 iii Ricky Dale Callen-b Sept 16, 1958



FRANCIS & GEORGIA CALLEN

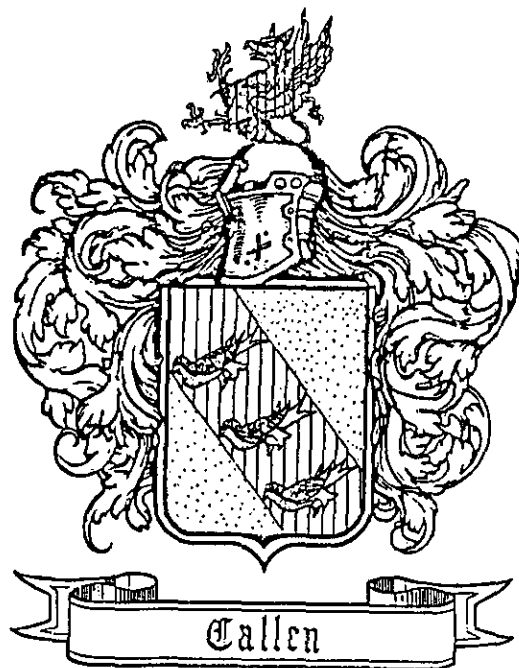

LINE OF SAMUEL CALLEN, SR - 6TH GENERATION

2,52-EDWARD D CALLEN/ Paul C/ Edward D/ Samuel M/ Samuel/ Samuel Callen Sr

(43H)EDWARD DICKEY CALLEN was born in Vicksburg, Mississippi on October 29, 1939; he is the son of Paul C and Carrie (Nelson) Callen. By occupation Edward is a pipefitter. On December 29, 1961 in Satsuma Alabama, Edward married JUDITH N HARTLEY who was born on November 3, 1943 in Satsuma.

Children

- i Melissa Nan Callen-b Mar 2, 1963
- ii Edward Dickey Callen, Jr-b Feb 9, 1964
- iii Michael Cole Callen-b May 1, 1967
- iv David Hartley Callen-b Dec 19, 1973

2,53-DOROTHY B CALLEN/ Kenneth E/ Edward D/ Samuel M/ Samuel/ Samuel Callen Sr

(43A)DOROTHY BELLE CALLEN was born October 23, 1942 the daughter of Kenneth E and Mary Edna (Thomas) Callen. "I was born in Mobile Alabama, where my father worked during the War as a welder. I vaguely recall seeing a ship launched, although my Mother tells me that we saw many.

My first real memory is of living in Shreveport, La. We moved to Vicksburg, Ms when I was about five. I started school and briefly attended a small school in Alabama.

"We moved from Vicksburg to Russellville, Ala where Dad was the mechanic at a rock quarry. We moved to Texas when I was eight, I was a little disappointed there weren't cowboys and Indians everywhere. There were also no homes to be had. We spent the summer in a boarding house waiting for a house to buy. Almost every day that summer my Mother and I went to the beach. We did get a house before Fall and my childhood in Lake Jackson, Texas until in Shreveport, La., in 1960.



JOHN & DOROTHY LAIRD
I spent the rest of my childhood in Lake Jackson, Texas until I went away to college in Shreveport, La., in 1960.

In the years between 1951 and 1960, especially the last few years, my life and those of my friends revolved almost entirely around the beach. We spent every moment possible at the beach, if we could get a way out there, or water skiing if we could get one of the dads to take us.

In 1961 I transferred to the University of Houston and almost didn't get there in time. The hurricane "Carla" struck the gulf coast just a few days before I was supposed to leave for school. We took a few clothes and the dog and went inland. We stayed away a couple of days and got home just as the sun was coming up. There was water

everywhere. We stopped just on the edge of town on a levee road and walked in. About three blocks from the house the water was waist deep, but when we got home there was no water inside and only a little damage to the roof and some windows. I was one day late getting to school.

I left school in 1963 without graduating and lived and worked in Houston until I married in 1968, to JOHN R HINMAN from Plains, Kansas. He was a commercial pilot and we lived in western Kansas where his family had a small aircraft business. We divorced in 1971 and I moved to Kansas City, Mo. in 1973.

I worked for a financier and a construction company for a time and went back to school to get a BS degree and later a MBA from Rockhurst College. In 1977 I began work at a local utility company.

Since 1984 I've been the supervisor of budgets for the company's power generating stations. I married again in 1986 to JOHN ROBERT LAIRD, a native Kansas Citian who is an officer of Ozark Kenworth. We live outside of Liberty, Mo., a community about 15 miles northeast of Kansas City. I took up horseback riding after moving to Kansas City and gave that up after several unfortunate falls and the rising cost of maintaining a horse. Bought a house and a duplex in Kansas City in 1978 which I rented out for several years. I sold both shortly before remarrying.

I play tennis and take golf lessons. I was active in Republican politics at the local and state level and was a Committeewoman when I lived in Kansas City, but do not participate in politics now."

Dorothy is also interested in family research and is a co-author and co-researcher of this book.

2,54-IXCHEL S DIMETRAL/ Evelyn F Callen/ William E/ Samuel M/
Samuel/ Samuel Callen Sr

(43A)Ixchel Star Dimetral was born in 1949 "is now a principal dancer and choreographer with the AVAZ International Folk Dance Ensemble. She is married to BRUCE WAYNE MAERKER of Tucson, Arizona who is a courier for Federal Express."

2,55-DIANA L DIMETRAL/ Evelyn F Callen/ William E/ Samuel M/
Samuel/ Samuel Callen Sr

(43A)Diana Lynn Dimetral was born in 1951 "is married to ROY ALLEN POOLE of Arcadia, California. Diana Lynn graduated from Arizona State University and San Marcos University, Texas and is a teacher. Roy is an Air Force Major (Pilot) at Randolph Field, Texas. They have two daughters."

Children

- i Ariel Caitlin Poole-b ca 1977
- ii Collin Mackenzie Poole-b ca 1982

2,56-WILBUR D CALLEN/ Eden R/ Samuel V/ Robert T/ Samuel/ Samuel Callen Sr

(43J)WILBUR DEAN CALLEN was born on November 28, 1937 in Nodaway, Andrew Co, Missouri. On January 6, 1962 in St Joseph, Mo he married JEAN ANN BISHOP who was born on August 18, 1935 in St Joseph. He was in the U.S. Army with duty in Germany. He is a machinist by trade. Jean is a retired elementary school teacher. They are currently living in St Joseph, Mo.

Children

twin i Deana Sue Callen-b Aug 2, 1967
twin ii Jeana Sue Callen-b Aug 2, 1967
m Mr. HUBER they have 2 children

2,57-CHRISTENA M CALLEN/ Cody L/ Samuel V/ Robert T/ Samuel/ Samuel Callen Sr

(43I)CHRISTENA MAE CALLEN was born on May 28, 1939 in Amazonia, Missouri. On November 12, 1960 in Texas she married GEORGE DEWEY BARTON. Christena is a secretary.

Children

2,66 i Valerie K Callen-b Sept 4, 1961
ii Rebecca Lynne Barton-b Dec 26, 1962

2,58-MARY ANN CALLEN/ V Kenneth/ Samuel V/ Robert T/ Samuel/ Samuel Callen Sr

(43B)MARY ANN CALLEN was born September 13, 1946 in Scottsbluff, Nebraska. She is the daughter of V Kenneth Callen and Gladys (Pieper) Callen. On June 15, 1975 in Las Vegas, Nevada she married ANDREW KIENZT who was born in Donegal, Ireland on November 11, 1945. Mary Ann is a housewife and Staff Manager of Mechanized Systems at U.S. West Telephone Co. in Denver, Andy is a Computer Operator at the U.S. West Telephone Co.

Children

i Kevin Andrew Kientz-b Mar 11, 1980
ii Kimberly Ann Kientz-b Apr 10, 1984

2,59-MELVIN K CALLEN/ V Kenneth/ Samuel V/ Robert T/ Samuel/ Samuel Callen Sr

(43B)MELVIN KENNETH CALLEN was born September 28 1947 in Scottsbluff, Nebraska. He is the son of V Kenneth and Gladys (Pieper) Callen. On June 10, 19__ he married JANICE SUE GRIFFITH. Janice was born in Clarinda, Iowa on October 21, 1946. Melvin is a Field Engineer Director of Electrical Construction of Western Area Power Administration.

"Melvin built his own airplane using blueprints only (no kit) -- it's a biplane (Skybolt). He finished it summer of 1988. He took lessons and training and got his Pilot's License. In August of 1989 he piloted his plane to Ft. Morgan (Colorado) to give his Dad and Mother; and his

Mother; and his brother Bob a ride (one at a time) taking us over the towns of Ft. Morgan and Brush. What a big thrill that was to see the town and country from his airplane and with him flying it!!!"



Children

- i Laramie Lin Callen-b Sept 9, 1969
- ii Lance Melvin Callen-b Feb 8, 1972

2,60-VERNON HUGH CALLEN/ V Kenneth/ Samuel V/ Robert T/ Samuel/ Samuel Callen Sr.

(43B)VERNON HUGH CALLEN, "Hughie" was born September 7, 1950, in Scottsbluff, Nebraska. He is a truck driver, mechanic and assistant to Engineers testing oil wells at Prudhoe Bay, Alaska. On May 12, 1968 in Brush, Colorado he married JACQUILYN HELD who was born April 13, 1949 in Brush, Colorado. Jacquilyn is a housewife.

Children

- i Shawn Kenneth Callen-b Nov 7, 1968
- ii Jason Tanner Callen-b Feb 26, 1979

2,61-ROBERT V CALLEN/ V Kenneth/ Samuel V/ Robert T/ Samuel/ Samuel Callen Sr

(43B)ROBERT VANCE CALLEN was born October 7, 1952 in Scottsbluff, Nebraska. He is the son of V Kenneth and Gladys (Pieper) Callen. He married JEANNE "ELLEN" BAILEY on October 19, 1974. She was born in Brush, Colorado on November 4, 1955. Robert is a linesman - electrician for Western Area Power Administration; Ellen is a receptionist in the City Office, City of Windsor, Colorado. They have no children.

2,62-RODNEY J CALLEN/ V Kenneth/ Samuel V/ Robert T/ Samuel/ Samuel Callen Sr

(43B)RODNEY JAMES CALLEN was born November 30, 1953 in Morgan County. He is the son of V Kenneth and Gladys (Pieper) Callen. He married 1st LESLIE COTTRELL, 2nd MARY ALICE DIDANITO in Portland, Maine on July 6, 1985. Rodney is a Supervisor at Arrow-Hart Mfg. Co in Brunswick, Maine, Mary is a housewife and does office work.

Child of Leslie

- i Charles (Cal) Kenneth Callen-b June 30, 1980

Children of Mary

- ii Mary Anne Callen-b Mar 30, 1986
- iii Sarah Agnes Marie Callen-b July 8, 1988

2,63-GEORGE R CALLEN/ G Francis/ Robert R/ Robert T/ Samuel/
Samuel Callen Sr

(43C)GEORGE RAYMOND CALLEN was born February 17, 1944, the son of
G Francis and Georgia R (King) Callen. On October 6, 1973 he
married LINDA K BURHAM.

Children

- i Kelly Leanne Callen-b Oct 6, 1972
- ii Bradley Raymond Callen-b Sept 18, 1974

2,64-ROBERT L CALLEN/ G Francis/ Robert R/ Robert T/ Samuel/
Samuel Callen Sr

(43C)ROBERT LEE CALLEN was born on June 15, 1952. He married
BRENDA LEA AKINS on March 1, 1975.

Child

- i Robby Lee Callen-b March 20, 1977

2,65-RICKY D CALLEN/ G Francis/ Robert R/ Robert T/ Samuel/ Samuel
Callen Sr

(43C)RICKY DALE CALLEN was born September 16, 1958, the son of G
Francis and Georgie (King) Callen. He married SHIRLEY LORETTA
ROGERS on December 9, 1978, they divorced August 22, 1983. Ricky
married 2nd to MELANIE PLUMMER MILLER on June 8, 1984.

Children

- i Lena Renee Callen-b June 1, 1979
- S/D Taundra Miller-b Aug 15, 1979
- S/S Dustin Miller-b July 11, 1982
- ii Courtney Gail Callen-b June 9, 1985

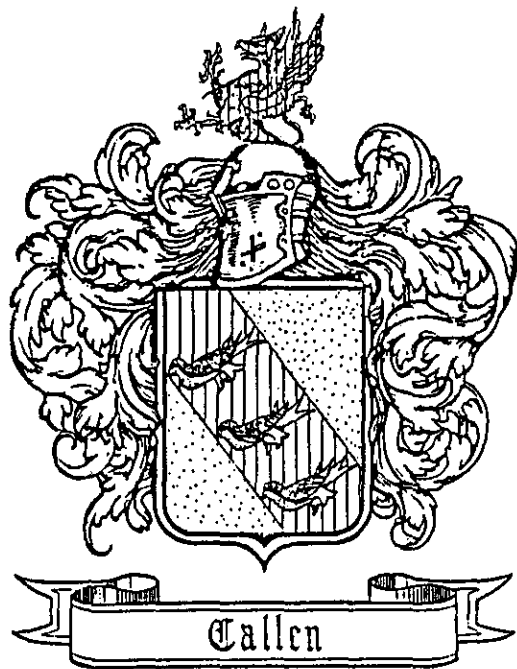

LINE OF SAMUEL CALLEN, SR - 7TH GENERATION

2,66-VALERIE K CALLEN/ Christena M/ Cody L/ Samuel V/ Robert T/
Samuel/ Samuel Callen Sr
(431)VALERIE K CALLEN was born on September 4, 1961 in Dallas,
Texas. She is the daughter of Christena Mae Callen. Valerie is
living in Georgia and is a secretary.

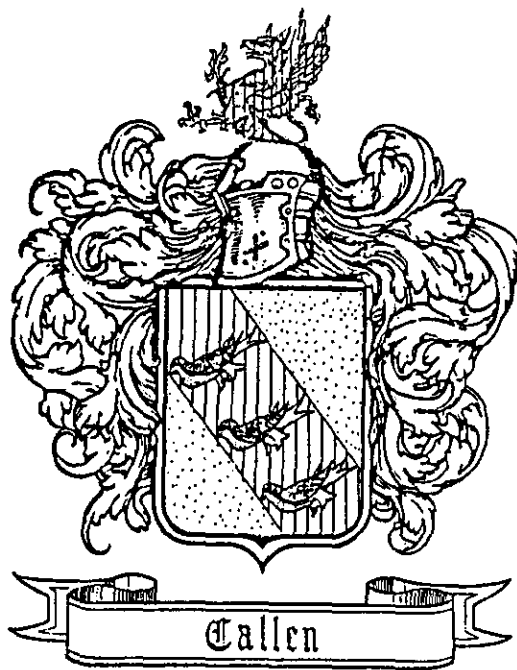

LINE OF WILLIAM CALLEN SR.

3,1-WILLIAM CALLEN SR. was born (55F) May 12, 1735??(not verified), probably in the colonies in Lancaster Co, Pennsylvania. William was possibly a son of John Callen a Scotch-Irish immigrant who settled near Hogestown in 1737 which was at that time part of Pennsborough Twp, Lancaster Co, Pennsylvania (see pg 8 & 9).

1762 - Around 1762 (45) William married ELIZABETH TAYLOR of Virginia, she was the daughter of Henry and Susan Taylor.

1768 - (2) William Callans is listed as a tax payer in East Pennsborough Township, Cumberland Co, Pa. He was taxed for 1 horse, 1 cow, and 100 acres of land - having 30 acres of that land cleared. (Cumberland Co tax list pg 3 - also on page 4 is listed Jonathan & David Hoges and John & William Orr, which are two family names that appear as living near the immigrant John Callen near Hogestown, Pa.)

1769 - The 1769 tax record for West Pennsborough Twp, Cumberland Co shows a William Camelin taxed for 1 horse, 1 cow, with 100 acres of land and 35 acres cleared. We feel that the name was misspelled, it is not unreasonable to think that William cleared an additional 5 acres in this one year period.

(45) "There is some indication that William and Patrick were brothers ... and that William went down the Shenandoah Valley of Va. He first settled in Augusta Co, Va next to Thos. Stuart in 1769. The Stuart family and the Kirkpatrick family of Cumberland Co, Pa ended up in Mecklenburg Co, N.C. and intermarried with the Callens."

1769 - November 6th William Calin was a teste (witness??) to a land transaction on Christian's Creek in Augusta Co Va. The transaction was between William and Margaret Jameson & John Jameson (Chronicles of the Scotch-Irish Settlement in Virginia)

1769 - November 8th William Callen was surveyed 280 acres, adjoining Thomas Stuart, Henry Dawson, and James Hurs (or Heers). (Abstracts of Surveys (Rockingham Co, Va) 1761-1691)

1769-1770 - (43A) Settlements were being renewed. In Bedford County, Pa (which became Westmoreland County in 1773) land could also be acquired from Virginia. "Tomahawk rights" were recognized, so that squatters were given title, defacto. Both colonies allowed a pre-emption right by improvement. A majority of settlers in the forks of the Yough River retained their lands under Virginia jurisdiction. After 1769, with the opening of the land office, rights were granted by the Penns. (We are unsure at this time - but this may explain why William is shown both in Pennsylvania and in Virginia at the same times.)

1772 - Augusta Co. Va court records show a Patent was issued November 17, 1772 to William Callen and wife Elizabeth - corner Henry Dawson; Teste: John Cunningham, Patrick Buchanan

1777-1778 - (5)William was a Lieutenant in the 2nd Battalion, 3rd Company, under the command of Col. John Perry of the Westmoreland Co. Pa. militia, Barr's Detachment. On March 11, 1778 his unit was ordered to Indian Country on expedition, by Brig. Gen. Edward Hand, Commanded by Col. Alexander Barr - (Pa Archives Series 6, Vol 2, pg 303-309). (55A)Pay for his service began Feb 10, 1778 and ended on March 8, 1778 - 27 days pay - \$27.00 per month. Amount paid 18 lbs, 4 shillings & 6 pence, plus 40 miles subsistence pay each day.

1780 - William Callen held land adjacent to the McIllduff family in Franklin Twp, Westmoreland Co, Pa. ("History of Westmoreland Co")

1783 - William Callan is taxed in Hempfield Twp, Westmoreland Co, Pa. for 200 acres of land (possibly Bounty Land for his military service) 3 horses, 3 cattle, 6 sheep (Pa Archives Series 3, Vol 22, pg 403)

1785 - William Callen is named as an administrator for the estate of Joseph Irwin in Westmoreland Co, Pa.

1786 - William Callen is taxed in Franklin Township, Westmoreland Co, Pa (Pa Archives Series __, Vol __, pg __)

1787 - (45)"Wm Callen Sr....purchased land in 1787 in that part of Mecklenburg Co, [North Carolina] that became Cabarrus Co. N.C. in 1792." (57)The two tracts of land were joined together and were bought from Peter Burns. The land was located "on the east side of Coddle Creek". The first of these two tracts was sold to his son William Jr in 1798. (see Appendix B, pg 359 & 361)

1790 - The first U.S. census in 1790 shows William Calland listed in the Salisbury District in Mecklenburg Co, North Carolina (pg 162 - 1st column) He is listed with 3 males 16 years and upwards; 1 female; 2 slaves. (Same page column 2 lists Valentine Kirkpatrick - see 3,5)

1800 - The 1800 U.S. census for Cabarrus, North Carolina shows William Callon Senr. with 1 male over 45 years of age; 1 female over 45; and 3 slaves.

1810 - The census shows a Wm. Callens in Cabarrus Co (pg 365); and also a Wm. Callen in Mecklenburg Co. (pg 51). It is unclear which one is William Sr, and William Jr, or if one is Wm III:

Wm. Callens in Cabarrus Co is shown with

3 males under 10 years of age; 1 male over 45 years;
1 female under 10; 1 female 26 to 45 years

Wm Callen in Mecklenburg Co is shown with

3 males under 10; 1 male 10 to 16 yrs; 1 male 26 to 45 yrs;
2 female under 10; 1 female 10-16 yrs; 1 female 26-45 yrs.

(49)William died July 19, 1815???(not verified) in North Carolina. Elizabeth died after 1810 and is buried in Cabarrus, N.C.

Children

(may be a partial list)

- 3,2 i John Callen-b ca 1765
 - 3,3 ii James Callen-b ca 1770
 - 3,4 iii William Callen Jr-b ca 1772
 - 3,5 ? iv Thomas Callen-b March 20, 1762
- (? = Indicates he may be a son, but not proven.)

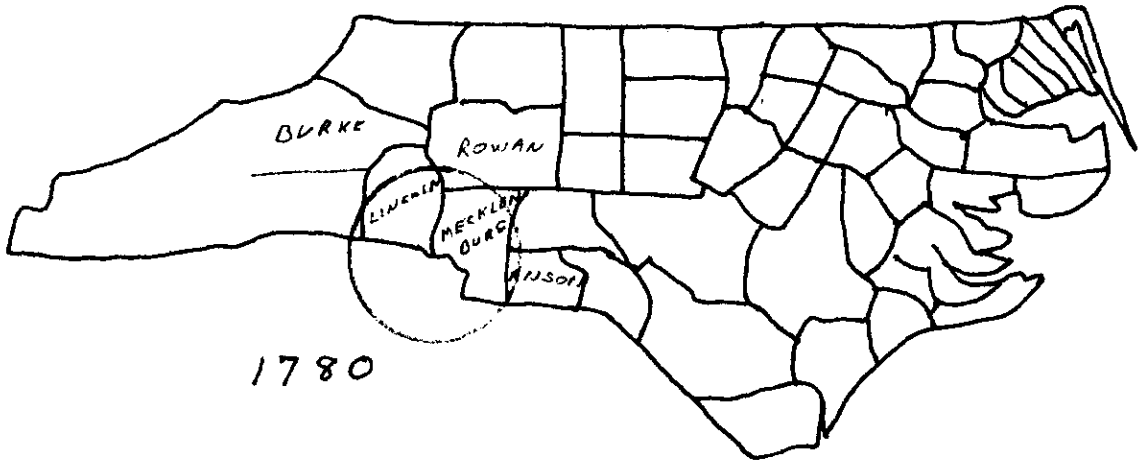
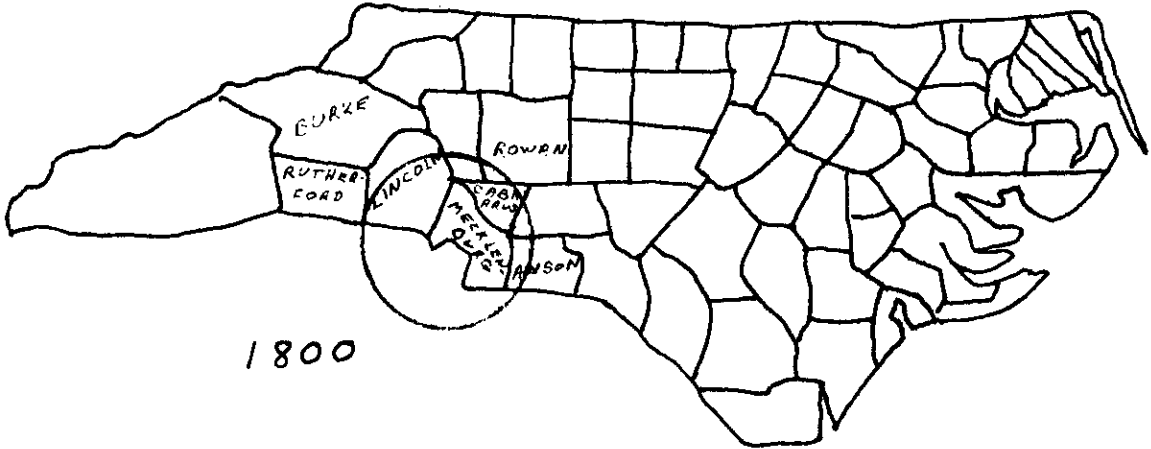

NORTH CAROLINA

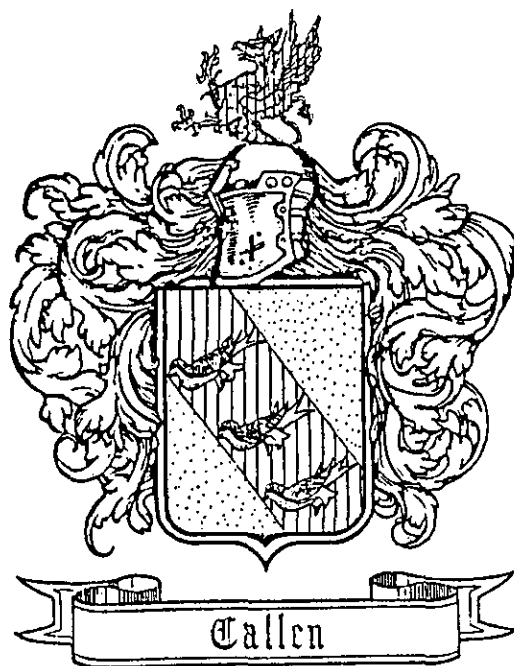

LINE OF WILLIAM CALLEN SR - 2ND GENERATION

3,2-JOHN CALLEN/ William Callen Sr

(55F)JOHN CALLEN, Sr was born (55H)around 1765, he is believed to be the son of William Callen Sr and Elizabeth (Taylor) Callen. Around 1794 John married (45)NANCY "AGNES" KERR (or KARR) who was born ca 1773.

(56)(see Appendix C, pg 370)In 1795 John Callen bought land at an auction, the land was located "on the waters of Goose Creek" in Mecklenburg Co, N.C. This land had apparently been seized by Act of Assembly for non-payment of "publick taxes", and was auctioned off to the highest bidder. The acreage and cost on the deed are unreadable.

In 1798 John Callen bought land from John Mitchel paying 84 Pounds Ten Shillings, the land was located in the Rocky River area of Cabarrus Co, N.C. In 1809 John Callen sold this land (60 acres) to James Dickson for \$495.00.

John Callen purchased another parcel of land on Goose Creek in 1810. This parcel was 200 acres "more or less", the purchase price was \$390.00.

In 1822 John Callen bought two more tracts of land on Goose Creek, he paid ten dollars per 100 acres; one parcel contained 20 acres, the second parcel contained 90 acres.

John died (50D)June 22, 1825 (50A)in Mecklenburg, North Carolina; Agnes died January 19, 1846 aged 72 years 10 mo's and is buried in Little Sandy Ridge Presbyterian Church Cemetery, in Lowndes Co., Alabama.

Children

- i daughter - see 1800 census Cabarrus Co, N.C.
- ii son - see 1800 census
- 3,6 iii Elizabeth Callen-b ca 1796
- 3,7 iv Ross Callen-b Jun 15, 1800
- 3,8 v John Kerr Callen-b Jan 13, 1805
- 3,9 vi Nancy Callen-b ca 1807
- 3,10 ? vii Dorcas Callen-b Feb 14, 1809 (may be d/o William?)
- ?viii Thomas Callen(s)-b (1802)
- 3,11 ? ix Ellis C Callen-

? - indicates these may also have been children of this couple, but not agreed upon by all researchers/correspondants and no proof at this time.

will of JOHN CALLEN

(filed Mecklenburg Co, North Carolina)

In the name of God Amen

I JOHN CALLANS of the State of N Carolina and County of Mecklenburg being under very Declining circumstance of health and remembering that it is appointed to all men to die and at the same time being of

a sound mind and memory Do publish this my last will and Testament in manner and form as follows - viz -

Imprimis: I commit my body to the dust to be buried in a decent manner, at the discretion of my Executors: and my Soul to God who gave it hoping and confiding in the mercy of God according to the provisions and tenor of that new and well ordered covenant

And my dying council to my Dearly beloved wife and my children Severally, viz: that they all be found walking in the way of Gods commandments that through riches of infinite mercy we may all be prepared to meet in a better world,

Item - As touching the worldly substance which God in his good providence hath bestowed upon me I Dispose of as follows - viz -

Imprimis: I devise that all my just debts be paid either out of the crop now in the ground: and should there by any failure in that out of the property that my Exrs may judge can be best spared

Item: The whole remaining property I commit and hand over to my Exrs. in trust to be kept together for the comfort and maintainance of my well beloved wife and children, and for the education of my children. I devise that out of this common property all my single children be apportioned off when they shall come of age or marry, and made equal to those that are already married and apportioned off.

Item: I devise to my well beloved wife Agness her full legal share of my landed property during her natural life: and of my perishable property three times as much as will fall to the equal apportionment of any child and forever at her disposal

Item: I devise that all the balance of property after the preceeding apportionments and my wife's legal share of land after her decease be the common and equal property of all my children

Item: I put it into the powers and discretion of my Exrs from time to time to sell any property, that in their judgment the interest of the estate may require.

Finally, I do hereby constitute and appoint my dearly beloved wife Agness and my true and faithful friend Robert Allen the Exrs of this my last will & Testament, Published this 16th [of June] A.D. 1825

In witness whereof I have hereunto set my hand and seal

In presence of

John Crilock/Carlock/ or Earlock?

John Callen - Seal

John M Wilson



LITTLE SANDY RIDGE CEMETERY

3,3-JAMES CALLEN/ William Callen Sr

(55A)JAMES CALLEN was born around 1770, the son of William Sr and Elizabeth (Taylor) Callen. (55A-55D)In July 1794 in Cabarus Co, N.C. he married OLIVIA H STEWART (STUART) who was born (55H)around 1762 the daughter of Thomas Stuart. (45)The Stuart family were neighbors of William Sr in Augusta Co, Va

(57) On July 25, 1811 James Callons sold 69 acres of land to John H Plunket for \$6.00 per acre, the land located on the waters of Coddle Creek in Cabarrus Co. N.C. The deed was not recorded until the April session of 1822. (see Appendix B, pg 365 & 369)

(45)Around 1819 James and his family moved to Dallas Co, Alabama.

(50A)James died February 20, 1842 aged 72 years, and Olivia died July 18, 1846 aged 84 years. Both are buried in Dallas Co. Alabama at Lebanon of Mount Vernon Cemetery "which is located two miles north of Summerfield on county road #37, north of Selma Alabama."

Children (all born Cabarrus Co, NC)

- 3,12 i William Callen III-b Nov 4, 1794
- ii son - name unknown (see census records)
- 3,13 iii Catherine Callen-b ca 1794-1800
- 3,14 iv Elizabeth Callen-b Dec 4 1801 d Dec 13, 1852
- 3,15 v Mary "Polly" Callen-b ca 1806
- 3,16 vi Anna Callen-b ca 1807

will of JAMES CALLEN

(filed Dallas Co. Alabama - Will Book A pg 199)

I, James Callen, of the County of Dallas and State of Alabama, do hereby make and publish this to be my last will and Testament revoking all others, heretofore made.

Item the first: My will and desire is that my Wife Oliva Callen, shall have the use of my plantation or such part that will be sufficient for her use, also 3 Negroes of her own choice, two Horses, twelve stock cattle, Ten 1st choice of hogs, Two Hundred bushels corn, with all the plantation tools, one waggon and all kitchen furniture, all of which I loan to her during her natural life and at her Death, my Will and desire is that all the property that I have loaned my wife, Oliva Callen, shall be equally divided between William Callen, Elizabeth George, Mary Choate and Anna Martin, all of which I give to them and their Heirs forever.

Item 2: I bequeath to my Daughter, Catherine Callen, one negroe woman to be chosen by herself after her mother has made choice of her Three negroes, also one Thousand dollars in money to be placed in the hands of William Choate (whom I appoint her Guardian for life, she being incompetent to manage her on business) to be used for her support.

Item 3: I will and bequeath to James Callen George, son of Alexander George, the sum of one hundred dollars to him and his Heirs forever.

Item 4: My will and desire is that all my property not heretofor disposed of be sold to the highest bidder and the proceeds thereof be equally divided between William Callen, Elizabeth George, Mary Choate and Anna Martin.

Item 5: My Will and desire is that my old Negroe woman Dinah, have the use of her time dureing her life.

Item 6: I hereby appoint William Choate, executor of this my last will and Testament. Signed, sealed, and delivered this 10th day of December one thousand Eight hundred and forty one in presence of James Chambliss and John Manderson.

3,4-WILLIAM CALLEN JR/ William Callen Sr

(45)WILLIAM CALLEN JR was born around 1772. (55A)He married SARAH ALEXANDER on May 5, 1798 in Cabarrus Co, North Carolina, she was born around 1770.

(57)(see Appendix B, pg 361)In 1798 William Jr bought land from his father "on the East Side of Coddle Creek" in Cabarrus Co, N.C. He paid 90 Pounds for the one hundred acres of land.

In 1801 William Callons bought an additional 90 acres of land "on Coddle Creek" for 50 Shillings per hundred acres. This land adjoined the land of William Callons Senr.

In 1815 William Callens/Callans bought 5 and 1/4 acres on Coddle Creek for 50 Shillings per hundred acres. And again in 1819 William Callan's/Callens bought a tract of land on Coddle Creek that adjoined his own property. This land tract cost 100 Shillings per hundred acres, total of acreage not shown on the deed.

William Jr died before 1829, for in 1829 his son (45)"James A [Callens] sold his land to [John] Phifer (see Appendix D, pg 379) and Sarah joined him in the deed, since part of the tract was dower land she got from Wm II deceased." (55H)Sarah died on January 21, 1840 in Cherokee, Alabama, she is buried in the Callan Cemetery.

Children

- 3,17 i Robert H Callen-b
- 3,18 ii George Alexander Callen-b
- 3,19 iii James Alexander Callen-b May 21, 1806

3,5-THOMAS CALLEN/ William Callen Sr

(60C-60E)THOMAS CALLEN was born March 20, 1762. There is conflicting family tradition as to where Thomas was born. One descendant said he was born in Dublin, Ireland - another descendant said he was born onboard ship crossing the ocean.

But there is also some indication that Thomas might have been the son of William Callen Sr and was born in the colonies. Family tradition from this line says that Thomas lived in North Carolina when he was young. The tradition further states that he had three brothers, John, James, and William, which are the names of William Sr's three known sons.

(57)In 1801 Thomas Callons bought 30 acres of land in Cabarrus Co, N.C. on the North East Side of Mulberry Branch. (Appendix D, pg 377)

There is a land deed between William Callons and Thomas Callons dated 1803, in Cabarrus Co, N.C. William sold Thomas 100 acres of land "on the East Side of Coddle Creek". (Appendix B, pg 363)

(60G-60C)On January 10, 1816 (or March 22, 1816) Thomas married JANE C WEST. Jane was born December 22, 1789 in North Carolina.

Thomas died January 4, 1848 and Jane died October 5, 1851; they are buried in Oak Hill, Carroll Co, Arkansas. Further information on this family line can be found in "Callen Family History" by Bob Graham - 1981.

Children

- i West Columbus Callen-b Feb 12, 1817 N.C.
died before Civil War enroute to Texas
- ii Elizabeth Karr (or Kansas) Callen-b June 23, 1818
m Mr. COX buried Carrollton, Arkansas
- iii Mary Burnet Callen-b Mar 23, 1820
- 3,20 iv Hannibal Dekalb Callen-b Jul 23, 1821
- v Thomas Bonepart Callen-b Oct 1, 1822
Bachelor d ca 1842/1844
- 3,21 vi Americus Vespusus Callen-b Mar 16, 1824
d 1917 in Oklahoma

vii Tennessee Sarah Jane Callen-b May 20, 1825
m A.D LEATHERS d Missouri
3,22 viii Augustus Gideon Callen-b Jul 18, 1826
ix Lodusky Pulaski Callen-b Jan 4, 1828
x Socratus Plato Callen-b Dec 31, 1828

LINE OF WILLIAM CALLEN SR - 3RD GENERATION

3,6-ELIZABETH CALLEN/ John/ William Callen Sr

(50A)ELIZABETH CALLEN was born around 1795/1796 in North Carolina, it is generally believed that she is the daughter of John and Agnes (Kerr) Callen, since census records show that John had a daughter born around the same time, and they lived in Mecklenburg Co, N.C. where Elizabeth was married.

(45)Around 1815 she married FRANCIS KIRKPATRICK in Mecklenburg, N.C. (48)(marriage date was omitted on original marriage bond, now on file in N.C. Department of Archives & History, Raleigh). Francis was born ca 1794 in N.C. the son of (46)Valentine and (50A)Martha (McMurray) Kirkpatrick. (46)"Several Kirkpatrick men and wives, including Francis and Laird, were charter members of Sandy Ridge Presbyterian Church in [1833], and other Callen families associated with the church at a later date" (50A)including James, John, and William.

(50A)Elizabeth died ca 1860-1867 in Butler or Lowndes Co, Alabama. After her death, Francis married Martha Gresham on May 16, 1867 in Lowndes Co. (50I)Martha was approximately 40 years younger than Francis, there were no children by this second marriage. Francis died ca 1871 in Butler Co, Alabama.

Children

- 3,23 i Nancy Kirkpatrick-b ca 1816
- 3,24 ii Samuel Alexander Kirkpatrick-b Jan 1, 1818
- iii John C(or G) Kirkpatrick-b Mar 9, 1823
d June 17, 1854 unmarried
- 3,25 iv Martha M Kirkpatrick-b ca 1826
- 3,26 v Sarah E Kirkpatrick-b ca 1828
- 3,27 vi Valentine Kirkpatrick-b 1830

3,7-ROSS CALLEN/ John/ William Callen Sr

(45)ROSS CALLEN was born June 15, 1800 in Mecklenburg Co, N.C. and is believed to be the son of John and Agnes (Kerr) Callen.

(50D)On September 18, 1821 he married ELIZABETH (White?) FOSTER. (50A)She was born February 3, 1803 (50D)in Ireland and was the daughter of Robert and Margaret (Duffy/Duffey) Foster. Elizabeth died December 26, 1873 and is buried in Little Sandy Ridge Cemetery in Lowndes Co, Alabama; Ross died June 6, 1888 and is buried in McWright Cemetery, Greenville Texas.

Children

- 3,28 i Nancy H Callen-b June 20, 1822
- 3,29 ii Margaret Farr Callen-b Jan 24, 1824
- iii Ann Clementine Callen-b Nov 27, 1825 d Nov 3 1834
- iv Mary Foster Callen-b Apr 25, 1828 d Mar 23, 1847
- 3,30 v John Carr Callen-b July 1, 1830?
- ? vi Robert H Callen-b Dec 15, 1833 (see 3,17)



ELIZABETH (FOSTER) CALLEN



ROSS CALLEN

Two letters have been preserved and handed down this family line. Carolyn Glass Warren now shares them with the family. (The first letter has been edited here to show only the history and the Callen information contained.)

(50D)"Elberton, Ga Feby. the 28th 1912
Mr. Sturgeon Foster Glass

My dear cousin:

I am going to try to write you what I can of the history of our people; that is the Foster side of them and perhaps if I get a good start may not stop there.

Your Great, Great, Great Grandfather and his wife were married in Dublin, Ireland...Robert Foster and Margaret Duffey was married...and to them was born two children, Henry and I think Elizabeth, in the old country. On account of their faith, they being Protestants and great strife having arisen in Ireland about that time between the Roman Catholics they became uneasy about their welfare and came across the water, landing at what port I am not aware, but finally they stopped in McLinburge, N.C...The Irish folks settled near the Stilwells after they came over. They had born to them William J., Ann Farr, and Penelope, Robert died at about 15 or 16 years of age. ROSS CALLENS married ELIZABETH, I don't know the date, but in 1832 my father left N.C. and came to Ga. In 1834 the Stilwell family, and the Foster family and Ross Callen followed, the Stilwells settled in Henry and the Fosters and Callens in Butts County, the later families on Towaligge River...

Uncle Ross and family went to Alabama when I was quite small, but I remember them and John Callen, too, and there was a family of Birds that was connected with them in some way. They stayed here a long time after Uncle went out there.

Your cousin, John F Stilwell"

(50D)"Dallas, Texas Nov. 28, 1948
Mrs. Ray Etter Glass,
Greenville

Dear Ray:

Some weeks ago when I was trying out my newly acquired vision, I visited a very old and badly neglected cemetery--McWright!--Just a flower here and there to place upon the sleeping places of kindred, friends--and to the first sweetheart of mine.

And there was another grave--Its location was vague, but its memory had been indelibly written on my childish mind--And I found that long neglected grave with its broken stone--of Ross Callen, born 1800--Died 1888.

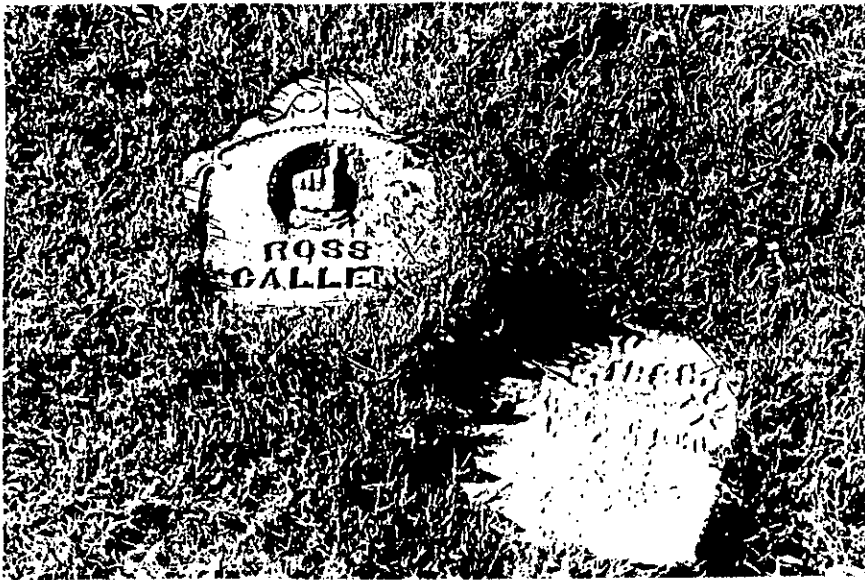

There are few people living now who would know anything about Ross Callen--for all the Glasses that might have remembered are gone...Uncle Ross Callen, as I understand, was a grand uncle of W.J.F. Glass (note he was W.J.F.'s grandfather on his mother's side) -- a grand old man whom cousin Will and Molly [meaning William J.F. Glass & Mary Eugenia Rebecca (Sheppard) Glass] loved so much

that they brought him to Texas with them. He didn't long survive. (Note: Lady Strauss had this headstone repaired and placed flat in a concrete frame on Ross Callen's grave in McWright Cemetery near Greenville, TX, in 1981.)

Mother and I were called to his bedside to see him pass. I(t) was my first time to understand the grim reality of life and death--and I stood by and saw him buried.

And on my recent visit a nephew and his three grown daughters stood beside me, and my nephew Cliff Quattlebaum turned to with a querry--Alf, I have heard that Uncle Ross Callen was a veteran of the War with Mexico. Do you know anything about it?

I don't! But the question aroused my interest. Born 1800, he might have known Andrew Jackson and all about the Battle of New Orleans. He was a man of education and doubtless a man of valor. Or he might have waded through the Florida everglades in search of Osceola. Or he might have fought at San Jacinto, beside Houston at 36. Or he might have walked beside Jefferson Davis, a member of volunteer company of Mississippi and other southern patriots who at the battle of Buena Vista arrived in time to save Zachary Taylor's army from possible destruction--a battle in (which) Jefferson Davis was shot through the heel which left him somewhat crippled for life--Who knows? What an era in which he lived!

He lived through 1861 to 65--he was no longer young to be sure, but a man who could carry on for 28 years longer must have had stamina. I do know that he carried on cheerfully, and when he could no longer whip the Rheumatism that he (would) take his gun and dog and hunt down the predatory animals that was the bane of the hen roost--and that he was a dead shot.

It occurs to me that if Uncle Ross was one who rendered military

service to our country that even at this late date he should no longer remain in a neglected grave of (nearly forgotten) dead.

Perhaps if you will carry this appeal to Charlie Glass or some members still living that they might trace his line back. The Glass's eventually moved to Emory and about that time W.J.F. Glass placed a head and foot marker, which has long since been broken down. It was driven over doubtless by a hearse that had become mired in the mud--the telltale tracs were still there.

I am sure that both Mr. Glass and Cousin Mollie loved him very much and regarded him as a sort of king among men. Further than that my vague childish knowledge does not click.

Yours very truly, Alfred M. Riley"

3,8-JOHN KERR CALLEN/ John/ William Callen Sr
(50A)JOHN KERR (or KARR?) CALLEN was born January 13, 1805. His family moved to Dallas Co, Alabama around 1827, (50A)and the church gave him a nice letter of recommendation:

To All Whom it May Concern:

Be it known, that - where as our young friend, John K Callen being about to leave this the place of his nativity with an intention of becoming an inhabitant of another State. Therefore we his friends feel ourselves in duty bound to recommend him to the good will & protection of all good people. We likewise certify that the said John K Callen now is & ever has been of an unblemished honest upright and moral Character. A young man of civil ensive and industrial habits. As such we in his behalf solicit the confidence patronage & protection of all good people. So long as he continues to support his present unspattered reputation. In testimony of which we have unto all our hands this 30th day of January 1827.

Jno M Wilson V.D.M; Hugh Steward Jur; John Orr; David Flour; T Leonard; Francis Kirkpatrick

(46)He married NANCY SIMPSON KENNEDY on October 15, 1829 in Dallas Co. Nancy was born February 19, 1811 in Chester Dist, South Carolina, she was the daughter of Hugh E and Elizabeth Harvey (Simpson) Kennedy.

John died on April 25, 1866 in Summerfield, Dallas Co, and is buried in the Valley Creek Cemetery. Nancy died June 14/15, 1897 and is buried with her husband.

Children

3,31	i John Ross Callen-b Sept 25, 1830
3,32	ii Eliza Jane Callen-b May 16, 1832
3,33	iii Mary Ann Callen-b Oct 7, 1833
3,34	iv Margaret Nelson Callen-b Jul 18, 1835
3,35	v Hugh Jackson Callen-Mar 20, 1837
	vi Amanda Minerva Callen-b Oct 24, 1838
	d-Jan 3,1856 never married

3,36 vii Nancy Serena Callen-b Apr 30, 1840
3,37 viii Lafayette Alexander Callen-b Feb 13, 1842
3,38 ix Hamilton Henderson Callen-b Nov 16, 1843
3,39 x Thomas Munroe Callen-b Sept 29, 1845
3,40 xi Ada Loraine Callen-b Jan 21, 1848
3,41 xii Ellen H Callen-b Nov 24, 1849
3,42 xiii Richard Cater Callen-b June 3, 1853

will of JOHN KERR (KARR) CALLEN
(filed Dallas Co, Alabama - dated Jun 29, 1865)

In the name of God, Amen.

I John K Callen, of the County and state aforesaid, knowing the uncertainty of life do make and publish this my Last will and Testament, hereby revoking and making void all former wills by me of any kind heretofore made.

Item 1: I desire that my funeral expenses and all my debts be paid as soon after my decease, as may be reasonable be done, so as not to interfere with that portion of my Estate herein after bequested to my wife.

2nd I give and bequeath to my beloved wife, Nancy S Callen, the tract of Land where I now reside, containing five hundred and forty (540) Acres, more or less, and also attached to the same, a tract of one hundred and Eighty seven (187) Acres bought of the Estate of J B King, to have and to hold during her natural life and at her decease to be divided equally between my 3 youngest children viz: Lorane, Ellen H, and Richard Cater.

3rd I desire also that my wife shall have the following property to be disposed of at her discretion Viz: All the household and kitchen furniture, carriages & buggies, wagons, farming utensils, the growing crop, all the cotton and grain, the horses, mules, cattle & hogs, also a flock of sheep containing about 35 in number, all the above belonging to my homeplace.

4th The residue of my Estate, the Lands, stock, growing crops and farming utensils, I give and bequeath to the balance of my children not named above, giving Nancy Sarena McElwain, LaFayette Alexander & Hamilton Henderson, and Thomas Monroe the advantage of five hundred dollars each over the others. John Ross, Eliza Jane, Margaret Nelson McLewain and Hugh Jackson in cause _____ of what they have heretofore received.

5th I do hereby make and ordain my wife Nancy S Callen, my sole Executrix of that portion of my Estate bequeathed to her and I request that no Bonds or returns to the Court be required on her part.

6th I do hereby appoint my sons John Ross & Hamilton H Callen my Executors of that part of my Estate not included in the portion given to my wife.

In witness whereof, I hereinto set my hand and affixed my seal this 29th day of June 1865.

CODICIL

I, John K Callen, having heretofore to wit: on this 27th day of June 1865 made and published my last will and testament in the presence of A H Mitchell, C N Briggs, and N Tate___ do now make this as a codicil to said last will. It is my will and desire that the land or any part of same bequeathed in the 2nd item of my said last will may be sold at such times and upon such terms as to credit as may be thought best by my said wife, Nancy S Callen, to sell said land whenever she may think proper whether for cash or on such credit as she may think best and to invest the proceeds of said sale shall be reinvested subject to the same trust contained in the said last will and my said wife may at her descretion give such part of this proceeds of said sale as she may think proper to my three youngest children viz: Lorance, Ellen H, Richard Cater aforesaid. And I hereby notify and confirm all the provisions of my said last will except at the same is modified by this codicil

3,9-NANCY CALLEN/ John/ William Callen Sr

(50A)NANCY CALLEN was born ca 1807 in North Carolina, she is believed to be the daughter of John and Nancy Agnes (Kerr) Callen. She married around 1837 and was the 2nd wife of LAIRD KIRKPATRICK son of Valentine and Martha (McMurray) Kirkpatrick (see 3,6). (50H)Laird was a farmer by trade.

(47)"Laird, youngest son of Valentine that we know anything about, is the sentimental favorite of your writer [Rodney Kirkpatrick]. From the things we know about him, he must have been a fun loving, obstinate, and free thinking (for his time) person. Laird was born in Cabarrus Co, NC, in 1793. He married Mary Sellers McCurdy of NC in March of 1823 in Cabarrus Co...

"Laird and Mary S McCurdy were two of the founding members of Sandy Ridge Presbyterian Church in 1833. On Feb 2, 1834, Laird and Mary asked for dismissal from Sandy Ridge so they could join Valley Creek Presbyterian Church near Selma.

"Mary died about 1837. After the death of Mary Sellers, Laird married Nancy Callens, who was born in NC in 1807. From this marriage came six children...

"On July 4, 1841, the Session of Sandy Ridge recorded that 'Laird Kirkpatrick having been suspended from church membership by the Session of Vally Creek Church & his case having been referred to this Session of said Church & he having made satisfactory acknowledgment & given evidence of repentance was restored and received as a member of this church.' The Session records of Sandy Ridge of April 23, 1842, states 'Whereas common fame charges Laird Kirkpatrick with the sin of intemperance & the members of session in a private consultation has agreed that a committee of our body should visit him endear (sic) or bring him to repentance and a confession of his sin...' The committee failed to accomplish its

task and session cited him to appear. He failed to appear and was cited a second time. Mr. N.H. Craig, Clerk of Session, reported that L.W. Flinn handed in a letter from Mr. Kirkpatrick from which it appears that he took exception to an accidental omission of the Clerk to say 'ordered by Session.' The Clerk was ordered to cite him again which was done. On June 19, 1842, 'the Clerk reported that he had given Mr. Laird Kirkpatrick a citation as ordered by Session and that he had treated it with contempt.' The Session ordered him excommunicated.

"On Oct. 28, 1848, Session recorded that '...Laird Kirkpatrick was restored to the privileges of the Church on his professing repentance for his former sins.' On Oct. 16, 1859, 'Laird Kirkpatrick appeared before Session voluntarily and confessed to the crime of being intoxicated recently and professed penitence (sic) for the offense and promised to avoid that crime for the future.' On Aug. 24, 1866, the Session records show that Laird Kirkpatrick and Loyd A Pickens were cited for '...being engaged in fight with each other and using profane language...' On July 13, 1866, these two men submitted a written statement to Session asking forgiveness. Several other instances are to be found in the Session records of more of Laird's antics.

"On Dec. 16, 1872, Laird was ordered by Dallas Co. (AL) Court to appear and give additional bond as a Justice of the Peace. The dates of death and place of burial are not know for Laird and Nancy.

Children of Mary

- i S/D Harriet A Kirkpatrick-
- ii S/D Amanda E Kirkpatrick
- iii S/D Eleanore A Kirkpatrick
- iv S/S Valentine Kirkpatrick
- v S/S Samuel McCurdy Kirkpatrick

Children of Nancy

- i James M Kirkpatrick-b 1838
- ii Mary S.M. Kirkpatrick-b 1840
- iii Elizabeth Sarah Kirkpatrick-b 1842
- iv Milton Kirkpatrick-b 1844
- v O. Monroe Kirkpatrick-b 1846
- vi William Laird Kirkpatrick-b Feb 28, 1848

3,43

3,10-DORCAS CALLEN/ John/ William Callen Sr

(50B)DORCAS CALLEN was born February 14, 1809 in North Carolina, possibly the daughter of John and Agnes (Kerr) Callen. Her family is shown in Mecklenburg, N.C. on the 1840 census, and Dorcas is shown in the 1850 census records in Dallas Co. Ala.

Dorcas married OWEN COLUMBUS HOOKS who was also born in N.C. on February 14, 1809 - research indicates they shared the same birthdate. Columbus was the son of Whitmell Hooks, and was a farmer by trade. He died December 21, 1848 in Mecklenburg, Co, N.C. Dorcas died August 10, 1894 in Summerfield, Dallas Co, Ala, and is buried in the Fellowship Baptist Church Cemetery in Summerfield, Alabama.

Children

- i John Ross Hooks-b Dec 26, 1832
- ii W Lafayette Hooks-b ca 1835
- iii Jane Hooks-b ca 1839
- iv Marcus Monroe Hooks-b Oct 28, 1842 d Jul 12, 1913
Birmingham, Jeff Co, Ala
- 3,44 v Julius Alexander Hooks-b Aug 22 1843
- vi Manerva Harris (Hooks?)-b Jan 11, 1848
d Jan 24, 1908

3,11-ELLIS CALLEN/ John?/ William Callen Sr
() ELLIS CALLEN might have been the son of John and Agnes Callen,
but there is no proof at this time. It is said that Ellis Callen
(47) married Nancy Kennedy's sister (see 3,8) ELIZABETH HARVEY
KENNEDY.

Only known Child

- 3,45 i Harris H Callen-b ca 1829-30

3,12-WILLIAM CALLEN III/ James/ William Callen Sr

(45) WILLIAM CALLEN was born November 4, 1794 in Cabarrus Co, North
Carolina, the son of James and Olivia (Stuart) Callen. (55H) On
December 10, 1816 he married (55A) "SALLIE" SARAH LITTLETON who was
born October 25, 1801. (55E) Sarah may have been married before as
her name has been written as Sarah O Dickerson.

(55A) William followed his brother to Dallas Co, Alabama by 1830.
William died March 18, 1860 and is buried in Lebanon Cemetery;
Sallie died in 1870 in Atlanta, Ga and is buried in the Valley Creek
Cemetery in Selma, Alabama.

Children

- 3,46 i Thomas Arnold Callen-b Apr 30, 1818
- 3,47 ii Mary "Polly" Callen-b ca 1820
- iii Elizabeth Callen-b ca 1823 m JAMES SHAW
- iv Jane Callen-b ca 1828 m JOHN M FLOYD
- v William Stuart Callen-b ca 1829
- vi Sarah Ann Callen- m THOMAS STEWART
- vii Nancy Lucinda Callen- m MATTHEW SMITH
- 3,48 viii James Cicero Callen-b ca 1838
- ix Alabama Callen-b ca 1839
- 3,49 x George Marian Callen-b ca 1841

will of WILLIAM CALLEN

(filed Dallas County Alabama - April 19, 1861)

In the name of God, Amen.

I, William Callen, of the county of Dallas and State of Alabama,
being of sound and disposing mind, do hereby make this as my last
will and testament.

First, I desire that my body be decently interred and after my death that my funeral expenses be first paid and out of the first monies that shall come into the hands of my executor herein after named. I further desire that the property which I shall die possessed of shall be disposed of as follows, viz:

that Salley Callen, my beloved wife shall remain in quiet and peaceable possession of the house that I now live in and so much of the land attached thereto as she may need for the use of the hands during her natural life, and I also give for her use and benefit during her life all the negroes which I may die possessed of, unless it should be necessary to rid some for payment of my just debts, except those herein after designated, also one waggon, four mules, all the hogs and cows corn and fodder on the plantation at my decease.

I further give and bequeath to my son James Cicero Callen, at and after the death of his mother, that part of my plantation known as my father's place, but now particularly designated as the northeast quarter ... also one half of all tools in my work shop and one half of all my books in Library.

And I further give and bequeath to my son, George Marion Callen at and after the death of his mother that part of my plantation known as my home place that now particularly designed as the southwest quarter... Also one half of the tools in my work shop and one half the books in my library.

It is my further will and desire that either of the forenamed sons, James Cicero or George Marion should die without issue then in that case of the survivor shall inherit all the land herein bequeathed and that the son inheriting the said land shall in five years after the death of his brother pay to the children living of William Callen, his brother, the sum of \$100 and under the same contingency, pay to the children of Thomas A Callen, his brother the sum of \$100.

And it is my further will and desire that if my servants, Nancy and Lindey shall have had 10 children each, which shall have lived to the age of 1 month, that they shall remain under the contract and guardianship of my sons James and Marion or either of them as free persons, and that they have used of the house and lot that Sarah Stewart now lives in and old negro patch in the swamp their lifetime, but if the above contingency does not occur, then this bequest is void. Now if the said Nancy and Lindey should have the above number of children as stipulated and placed to themselves as above directed, I further give to them \$100 each to be paid them by my executor, herein named.

It is my further will and desire that Wiley, the child of Rachel be free and under the control and guardianship of my executor herein after named, who is directed to pay to him upon his arriving at the age of 15 years, the sum of \$50 out of any monies in his hands as herein after provided for.

I further give and bequeath to my son, James C, the boy Henry, son of Lindey to him and his heirs. I give and bequeath to my son George M the boy John, son of Lindey to him and his heirs.

Now it is my will and desire that at and after my death of my wife, Sally, all my property not specially divided be sold on a credit of 12 months to the highest bidder by my executor herein after named, and the proceeds thereof equally divided amongst all my children or their legal representatives, deducting from Thomas A \$860 which he has already received; from Polly Culverhouse \$755 which she has received; from Elizabeth Shaw \$147 which she has received; from William Callen \$32 which he has rec'd; from Sarah Ann Stewart \$83 which she has received; from Nancy Lucinda \$128 which she has rec'd and it is further stipulated & expressly intended that my bequest made to each and all of my daughters, is to them, their heirs, the heirs of their bodies. It is also my will and desire that so much and all my land not needed and used by my wife during her lifetime, the profits, rents, use and _____ shall go to my sons James, and Marion individually.

And I do hereby nominate and appoint James C Callen to be executor of this my last will and testament, and I do hereby revoke and make void all former and other wills or will by me at any time or times heretofore made and hereby declare these presents to be and contain my last will and testament.

In witness hereof I, the said testator have to this my last will & testament written on 4 pages of one sheet of paper at my ahnd & seal this July 30, 1859.

William Callen

Witnesses: John K Callen; E T(P?) Cothran (see 3,32)

3,13-CATHERINE CALLEN/ James/ William Callen Sr

(55A)CATHERINE CALLEN was born around 1800. She was "incompetent to handle her own affairs." After the death of her parents, Catherine was placed under the guardianship of her brother-in-law William Choate. She died around 1845 in Dallas Co, Alabama.

3,14-ELIZABETH CALLEN/ James/ William Callen Sr

(55F)ELIZABETH CALLEN was born December 4, 1801 in N.C., the daughter of James and Olivia (Stuart) Callen. On September 10, 1822 she married ALEXANDER GEORGE who was born August 17, 1798 in Caldwell, Ky.

Elizabeth died December 13, 1852 (55H)and is buried in Pleasant Site. Alexander died March 12, 1877 and is buried in Wenchester Cemetery, both cemeteries are in Franklin Co., Alabama

Children

- 3,50 i Anna Adeline George-b Aug 13, 1823 in Ala
ii infant-
iii James Callen George-b Jun 16, 1826
iv Lucinda Davis George-b Jun 15, 1827 in Ala

3,15-MARY CALLEN/ James/ William Callen Sr

(55A)MARY "POLLY" CALLEN was born around 1806 (55D)in Cabarrus Co, N.C. On March 1, 1825 in Dallas Co, Alabama she married WILLIAM ALEXANDER CHOATE who was born around 1801/1803 in Tennessee. Through Polly's father's will they were appointed guardianship of Polly's sister Catherine.

William died (55D)June 23, 1844 in Dallas Co, and is buried in Lebanon, Mt Vernon Cemetery. Polly married 2nd to JOHN D MCGAHEE on September 23, 1848. She died in 1889 in Dallas Co, Alabama.

Children

(all born in Dallas Co, Alabama)

- 3,51 i Elizabeth O Choate-b Feb 17, 1828 d Dec 23, 1896
m HOWARD B CAMPBELL on Sept 30, 1845
ii Jamima Francis Choate-b ca 1831
iii Robert S Choate-b
iv William Isom Choate-b ca 1836
m ALABAMA CAMPBELL on Apr 4, 1855
v Mary Ann Choate-b
m THOMAS CUMMINGS on Dec 12, 1849
vi Rufus A Choate-b ca 1839
m AMELIA SAMPLE on Jan 20, 1864
vii Martha Jane Choate-b ca 1842 m Mr. MORRIS
viii Sarah Mexico Choate-b ca 1844 m RICHARD CARTER

3,16-ANNA CALLEN/ James/ William Callen Sr

(55A)ANNA CALLEN was born around 1807 (50B)in N.C. (55H)On December 23, 1824 in Alabama she married HENRY MARTIN. (50B)Henry was born around 1788 in N.C., Anna died before 1856, Henry died July 16, 1882 in Alabama.

Child

- 3,52 i Frances Olivia Martin-b Dec 31, 1832

3,17-ROBERT H CALLEN/ William Jr/ William Callen Sr

(45)ROBERT H CALLEN married in Cabarrus Co, N.C. (55H)on March 1, 1822 to ELIZABETH WALLACE. (50E)The Glass Family Bible has an entry that reads "Robert H Callen Senior departed this life October the 11th, 1834." Another entry reads "Robert H Callens was born December the 15th, 1833 (is this Robert H's son? - see 3,7).

3,18-GEORGE A CALLEN/ William Jr/ William Callen Sr

(45)GEORGE ALEXANDER CALLEN and his brother James moved to Monroe Co, Tennessee by 1830. They later joined again with his brother James in a move to Cherokee Co, Ala in 1837, but George "became dissatisfied, moved to Mississippi and by 1860 had settled in Yell Co, Arkansas. He had [married] MATILDA DAVIS in Cabarrus Co." around 1820. (55A)George died in Yell Co in 1863.

Children

- 3,53 i William D Callen-b 1836
- ii George M Callen-b 1841
- iii Solomon Callen-b 1843
- 3,54 iv Columbus Callen-b 1845
- v Lucinda Callen-b 1850
- 3,55 ? vi Catherine A Callen-

3,19-JAMES A CALLEN/ William Jr/ William Callen Sr

(45)JAMES ALEXANDER CALLEN was born May 21, 1806 and had moved to Monroe Co, Tennessee by 1830. He was married September 26, 1827 to MARY "MELISSA" MARTIN, "and John F Russell had [married] her sister Jane. The Russells settled in Cherokee Co, Ala and in 1837 James and [his brother] George left Monroe Co, Tenn and joined them."

Melissa died in 1845 and James married again; after 1848 to SARAH (unknown), and after 1879 to ELIZABETH T CULVERHOUSE. (55H)James died July 5, 1890 and is buried in the Callan Cem, Cherokee, Al.

Children of Melissa Martin

- i George W Callen-b 1834
- ii James M Callen-b 1839
- iii Martin V Callen-b 1841
- iv Andrew J Callen-b- 1843
- twin? v Pinkney Callen-b 1845
- twin? vi Sarah I Callen-b 1845

Child of Sarah

- vii Margaret Callen-b 1851

3,20-HANNIBAL D CALLEN/ Thomas/ William Callen Sr?

(60C-60D)HANNIBAL (or HANIBALD) DEKALB CALLEN was born July 23, 1821 in Bedford Co, Tennessee. (60A)He married ELIZABETH LEATHERS in Carroll Co, Arkansas. (60I)He served in the Civil War for the Confederacy. Hannibal died in 1878 and is buried in West, Texas.

Children

- 3,56 i Marion Callen-b 1844/45 Carroll Co, Ark
- ii Willie Callen-b 1846
- iii Thomas Bonapart Callen-b 1847
- iv Hannibal Dekalb Callen, Jr-b Feb 20, 1848
- m ELIZABETH MATTHEWS
- 3,57 v Socrates Polasky Callen-b Jan 8, 1854
- vi James "Jim" Callen-b

- vii Columbus Callen-b
- viii Riley Callen-b
- ix Dora Callen-b
- x John Callen-b

3,21-AMERICUS V CALLEN/ Thomas/ William Callen Sr?

(60C-60D)AMERICUS VESPUSUS CALLEN was born March 16, 1824 in Tennessee, he was the son of Thomas and Jane (West) Callen. On March 25, 1851 in Carroll Co, Arkansas, he married MARY BOYD who was born in Tennessee April 29, 1831. Americus was a farmer, Mary was a housewife. Americus died March 1, 1917 in Martha, Oklahoma; Mary died February 2, 1904 in Cordell, Oklahoma.

Children

- i Effie Jane Callen-b Jan 29, 1852
- ii Columbus Adolphus Callen-b Jun 5, 1853
- iii Americus Napoleon Callen-b Mar 29, 1855
- iv Mary Elizabeth Callen-b Feb 22, 1857
- twin v girl Callen-b Feb 22, 1857
- twin vi Thomas Bruce Callen-b Feb 7, 1859
- vii Bulcenia Ida Callen-b Jan 15, 1861
- 3,58 viii Socrates Plato Callen-b Jan 4, 1864
- ix Sarah Loduskey Callen-b Oct 19, 1870

3,22-AUGUSTUS G CALLEN/ Thomas/ William Callen Sr?

(60C)AUGUSTUS GIDEON CALLEN SR was born July 18, 1826 in Bedford Co, Tennessee. He was the son of Thomas and Jane (West) Callen. On September 11, 1849 he married SARAH CORDELIA AYERS, who was born August 22, 1833 in Tennessee. Augustus died January 26, 1918 in Farewell, Arkansas, Sarah died July 5, 1895.

Children

- i Parlee Oregon Callen-b Jan 20, 1851 d Oct 6, 1926
- ii West Jerome Callen-b Mar 9, 1853 Jan 11, 1923
- iii Leroy Monroe Callen-b Dec 31, 1854 d Feb 8, 1904
- iv Socrates Plato Callen-b Dec 30 1856 d Mar 16 1894
- v Elisha Jane Callen-b Jul 16, 1858 d Nov 6, 1858
- 3,59 vi Buenos Ayers Callen-b Mar 11, 1860 d Dec 5, 1948
- vii Lodusky Pulaski Callen-b Oct 9, 18__ d Sep 8 1917
- viii Whittington Columbus Callen-b Apr 14, 1866
d Dec 29, 1938
- ix Thomas McAllister Callen-b Mar 29, 1868
d Dec 24, 1944
- x Augustus Gideon Callen, Jr-b Jul 27, 1869
d Oct 19, 1922
- xi Sarah Elizabeth Callen-b Mar 25 1872 d Feb 9, 1894
- xii Issac Elhannon Callen-b Apr 17 1875 d Oct 23 1912
- xiii Ora Iva Callen-b Aug 23, 1878 d Oct 17, 1879

LINE OF WILLIAM CALLEN SR - 4TH GENERATION

3,23-NANCY KIRKPATRICK/ Elizabeth Callen/ John/ William Callen Sr
(50A)NANCY E KIRKPATRICK was the oldest child of Elizabeth (Callen) and Francis Kirkpatrick, she was born ca 1816 in Cabarrus Co. N.C. On December 23, 1834 in Lowndes Co. Ala she married JAMES H PERDUE. Nancy died probably before 1850. The family was living in Louisiana in 1872.

Children

- 3,60
- i Margaret Perdue-b
 - ii Martha Perdue-b
 - iii Franklin Perdue-b
 - iv Bolling Perdue-b
 - v Samuel K Perdue-b

3,24- SAMUEL A KIRKPATRICK/ Elizabeth Callen/ John/ William Callen Sr

(50A)SAMUEL ALEXANDER KIRKPATRICK was born January 1, 1818 in North Carolina. He was the son of Elizabeth (Callen) and Francis Kirkpatrick. Samuel was a farmer. On November 21, 1839 in Dallas Co. Ala Samuel married SARAH E DAVIS who was born in 1816 in South Carolina. She is believed to be the daughter of Leonard W Davis, whose will was dated July 10, 1818 and probated March 10, 1820 in Dallas Co. Ala, naming a daughter Sally.

(50A)At the September 19, 1847 meeting the clerk of Sandy Ridge Presbyterian Church "was ordered to grant Samuel Kirkpatrick and Sarah his wife letters of dismissal to join any church where God in His Providence may cast their lot." In the 1850 census they were located in Union Parish Louisiana.

Samuel died on July 17, 1895, Sarah died September 15, 1893. They are both buried in Holton Cemetery, La. Hwy #28, 22.5 miles west from Hinston, La.



HOLTON CEMETERY, LOUISIANA

Children

- 3,61 i Alexander Marvin Kirkpatrick-b July 10, 1840
- ii Narcissus Kirkpatrick-b ca 1842 m H.B. TANNER
- iii Caroline Kirkpatrick-b ca 1844
- m J.W. CAMPBELL Sept 11, 1864
- 3,62 iv John Thomas Kirkpatrick-b Feb 20, 1846
- v Martha Jane Kirkpatrick-b Feb 23 1848 d Jun 10, 1889
- m Henry CLAY PARKER on Sept 21, 1867
- 3,63 vi Frances A Kirkpatrick-b Oct 9, 1850
- 3,64 vii Augustus Crittenden Kirkpatrick-b May 31, 1852
- viii Elizabeth Maria Kirkpatrick-b Jan 5, 1855
- m MORRIS GILLETTE
- ix William Pinkney Kirkpatrick-b May 1860 La

3,25-MARTHA M KIRKPATRICK/ Elizabeth Callen/ John/ William Callen Sr

(50A-48)MARTHA M KIRKPATRICK was born around 1826-1828, the daughter of Elizabeth (Callen) and Francis Kirkpatrick. On January 7, 1853 in Lowndes Co, Alabama she married JAMES PHILLIPS. In 1872 they were living in Butler Co, Alabama.

Children (All born in Alabama)

- i Marion Phillips-b Nov 14, 1853 d July 5, 1854
- age 8 mo 21 days buried Little Sandy Ridge
- ii William Phillips-b 1855
- iii Fred (Frank?) Phillips-b 1857
- iv Ned Phillips-b 1858

3,26-SARAH E KIRKPATRICK/ Elizabeth Callen/ John/ William Callen Sr

(50A)SARAH E KIRKPATRICK was born ca 1828/1832 (her gravestone says 1835). On June 10, 1860 in Lowndes Co, Alabama she married J WILLIAM (or William J) HORNADAY/HORNADY who was born on June 9, 1816. In 1872 they were living in Butler Co, Alabama. William died February 13, 1894, Sarah died November 20, 1904; they are both buried in Sandy Ridge Cemetery, Lowndes Co, Alabama.

Children

- 3,65 i William M Hornady-b Mar 24, 1862/64 in Ala
 - ii Lizzie(?) Hornady-b 1866 in Ala m WILLIAM KNOX
 - iii John Hornady-b 1867 in Ala
 - iv George Hornady-
- (Note - John and George may be the same person.)

3,27-VALENTINE KIRKPATRICK/ Elizabeth Callen/ John/ William Callen Sr

(50A)VALENTINE KIRKPATRICK was born in 1830. On July 11, 1856 in Butler Co, Alabama he married MARY BILL. Mary was born in Alabama ca 1834. (47)"Descendents of Valentine were known to be living in California in the late 1960's. Valentine was a member of the Masonic Order; at different times he was a member of Camp Creek Lodge No. 251, Rose Hill Lodge No. 253, and Georgiana Lodge No. 285."

Children

(All born in Alabama)

- 3,66 i Indo Alice Kirkpatrick-b ca 1858
- ii Johnathan Cervantes Kirkpatrick-b Aug 1859
- iii George Alexander Kirkpatrick-b ca 1862
- 3,67 iv Francis Edward Kirkpatrick-b Jan 26, 1866
- v Joanne Kirkpatrick-b ca 1868
- vi Walter Kirkpatrick-b ca 1874

3,28-NANCY H CALLEN/ Ross/ John/ William Callen Sr
(50A)NANCY H CALLEN was born June 20, 1822, the daughter of Ross and Elizabeth (Foster) Callen. (50E)On December 24, 1840 she married ZENO PICKENS. After the death of Zeno she married WILLIAM DONALDSON. Nancy died after 1879.

Children (May be partial list)

- 3,68 i Samuel Ross Pickens-b ca 1852

3,29-MARGARET F CALLEN/ Ross/ John/ William Callen Sr
(50D)MARGARET FARR CALLEN was born Jan. 24, 1824 in Mecklenburg Co. N.C., the daughter of Ross and Elizabeth W (Foster) Callen. She was married 1st to ROBERT WILLIAM ALEXANDER GLASS on December 23, 1847. Robert was born December 31, 1822 in Mecklenburg Co. N.C., he is believed to be the son of Sarah (Varner) and Mr Glass. Robert W.A. Glass died an early death on June 8, 1854 aged 32 years.

Margaret was married 2nd to ROBERT H KIRKPATRICK who was born November 29 1820. Robert H Kirkpatrick died October 16 1900, Margaret died on March 9, 1905; all are buried in Little Sandy Ridge Cemetery in Lowndes Co. Alabama.

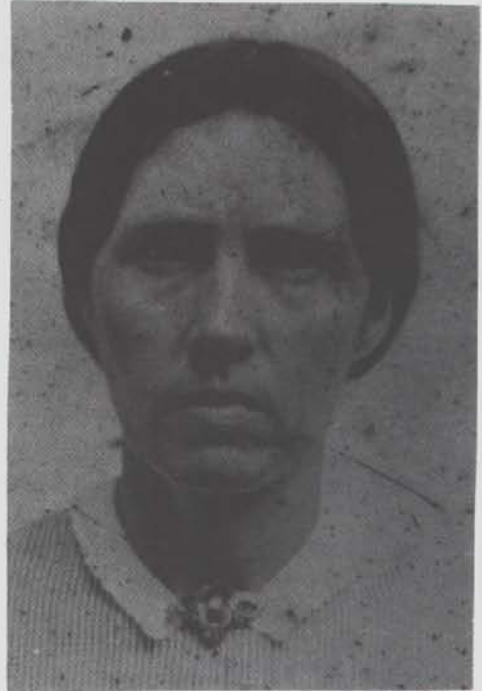

MARGARET FARR CALLEN

Children

- 3,69 i Ross C Glass-b Oct 4, 1848
- 3,70 ii William Glass-b Oct 17, 1850
- 3,71 iii Oliver Glass-b Feb 11, 1853

"Lady" Margaret Glass Strauss of Conroe Texas sent the following copy of Robert's marriage proposal to Margaret, and Margaret's reply. Lady says, "I personally think Margaret had already made up her mind before she received Robert's letter."

"Dear Miss:"

"Without leave I am about to take the liberty to address you a few lines which you will please excuse if not consistent with your mind. I have something to make known to you that is very nearly connected

with my happiness.

"Coming to the point at once, I will say in the presence of Him who is capable of judging all hearts that I love you with all the candor and fervency that one human being is capable of loving another. It is with and for you that I would gladly spend the time that God has appointed for me to live.

"Margaret, I would to God that you well knew the honest intentions of my heart, my object and only aim Margaret is your happiness. You are doubtless happy as you now live, but that does not argue that you cannot live happy only there. Margaret, all my future hopes is placed on thee and thee alone. Tell me Margaret, is all my hopes, the fond hopes that I would so fondly cherish, are they all in vain?

"Margaret, can you treat one that loves and adores you thus with coldness and indifference? God forbid. Margaret, shouldst thou turn a deaf ear to all my entreaties yet would I love you as long as this heart continues to palpitate, accepted or rejected, I certainly will rejoice to know that thou art happy. One kind word from thee would create within my heart a heaven of joy and happiness.

"Margaret, remember the anxiety that will attend every hour until the sunshine of brighter and happier days or the clouds of misery is thrown around my existence. May some angel carry home and implant in your heart the truths contained in this letter is the prayer of your very humble servant but despairing lover. Answer this if consistent with your mind as soon as convenient.

/s/ Robert William Alexander Glass
August 26, 1847"

"September 1, 1847
Robert Glass:

"I received a letter from you; the tidings contained in your letter were truly pleasant. You have written as though I have gained your affection. You wished that I knew the honest intention of your heart. I wish I did. You think I live very happy where I live, very true I do enjoy myself very well. You wish to know if I would turn a deaf ear to all your intreaties, I say, nay, your love for me is not rejected.

"I think it best for me to bring my letter to a close. I would not have written to you so soon if you had not requested me to write as soon as it was convenient, so I have.

Your Friend
/s/ Margaret F Callen"

3,30-JOHN C CALLEN/ Ross/ John/ William Callen Sr
(50D)JOHN CARR CALLEN was born July 1, 1830 (headstone says 1825?). He was born in North Carolina. On December 11, 1859 in

Lowndes Co, Ala he married REBECCA ELEFAIR GANDY. Rebecca was born on September 8, 1837, she was the daughter of Hampton Gandy. John died on April 21, 1904, Rebecca died on March 7, 1924; both are buried in Little Sandy Ridge Cemetery, Lowndes Co, Alabama.

Children

- 3,72 i James Robert Callen-b Sept 11, 1860
- 3,73 ii Margaret W Callen-b Dec 15, 1861
- 3,74 iii Lula A Callen-b 1863
- 3,75 iv Amanda Callen-b 1864
- 3,76 v Mary Ella Callen-b Mar 10, 1866
- 3,77 vi John H Callen-b
- vii Anna Callen- m WALKER MORRISON
- 3,78 viii Georgia B Callen-b Apr 20, 1871
- 3,79 ix Callie Callen-b Dec 14, 1874
- x Edgar Callen-
- 3,80 xi Elizabeth Callen-b 1878-79

3,31-JOHN ROSS CALLEN/ John K/ John/ William Callen Sr
(50C)JOHN ROSS CALLEN was born September 25, 1830 in Pleasant Valley or Valley Creek (later Summerfield) Dallas Co, Alabama. On April 25, 1861? he married LIZZIE C CULVERHOUSE. He died November 5, 1871.

3,32-ELIZA JANE CALLEN/ John K/ John/ William Callen Sr
(50C)ELIZA JANE CALLEN was born May 16, 1832. On December 10, 1850 she married EDWARD PINKNEY COTHRAN. Pinkney died December 22, 1902, Eliza died after 1911.

3,33-MARY ANN CALLEN/ John K/ John/ William Callen Sr
(50C)MARY ANN CALLEN was born Oct 7, 1833. On January 25, 1860 she married WILLIAM M GILMER. Mary Ann died January 14, 1861, she was buried at Valley Creek Cemetery, Dallas Co, Alabama - it is sad to realize that Mary Ann and William were married less than one year before her death.

3,34-MARGARET NELSON CALLEN/ John K/ John/ William Callen Sr
(50C)MARGARET NELSON CALLEN was born July 18, 1835. On November 26, 1854 she married SAMUEL PINKNEY McELWAIN. Margaret died in childbirth on March 10, 1862, and is buried in Valley Creek Cemetery, Dallas Co, Alabama. Samuel married 2nd to Mary A Culberhouse.

3,35-HUGH JACKSON CALLEN/ John K/ John/ William Callen Sr
(50C)HUGH JACKSON CALLEN was born on March 20, 1837. He married FANNIE LOGAN in 1854 or 1855. Hugh was a county judge in Chilton Co. He died June 13/14, 1897.

3,36-NANCY SERENA CALLEN/ John K/ John/ William Callen Sr
(50C)NANCY SERENA CALLEN was born April 30, 1840. She 1st married ROBERT N McELWAIN in 1861 and 2nd E.M. HORNBEAK in 1871. Nancy died on August 4, 1872, and is buried in Valley Creek Cemetery, Dallas Co, Alabama.

3,37-LAFAYETTE ALEXANDER CALLEN/ John K/ John/ William Callen Sr
(50C)LAFAYETTE ALEXANDER CALLEN was born on February 13, 1842. He married MRS. ANNIE HALL COLE in November of 1871, Annie was born May 29, 1842. Lafayette died December 7, 1874. Annie died May 3, 1919 and is buried in Old Live Oak Cemetery, Selma, Alabama.

3,38-HAMILTON H CALLEN/ John K/ John/ William Callen Sr
(50C)HAMILTON HENDERSON CALLEN was born November 16, 1843 in the Summerfield area in Dallas, Alabama. He served in Co 4 - 28th Regiment of volunteers under Col. John C Reid. Hamilton was married 1st to ANNIE E MARSHALL, daughter of Dr. Hugh Marshall. Annie died in 1866.

Hamilton then married EUGENIA FLORENCE "GENIE" HARRIS on October 12, 1871, she was the daughter of Melville and Sarah Amanda (Gilmer) Harris. Hamilton died November 12, 1878 and is buried in Valley Creek Presbyterian Church Cemetery.

Children

- 3,81 i Walton Eugene Callen-b Dec 19, 1872
- 3,82 ii Ada Lorain Callen-b Oct 3, 1874
- 3,83 iii Hamilton Harris Callen-b Apr 27, 1876
- 3,84 iv Eugenia Florence Callen-b Feb 10, 1879

3,39-THOMAS M CALLEN/ John K/ John/ William Callen Sr
(50C)THOMAS MUNROE (or MONROE) CALLEN was born September 29, 1845. He was married on his 24th birthday, September 29, 1869 to BESSIE GOLSON. Thomas died September 1891, he and his daughter are buried in the Old Live Oak Cemetery, in Selma, Alabama.

3,40-LORAIN CALLEN/ John K/ John/ William Callen Sr
(50C)ADA LORAIN CALLEN was born January 21, 1848. She married ROBERT W ARMSTRONG STARK? on January 24, 1871. She died after 1911.

3,41-ELLEN CALLEN/ John K/ John/ William Callen Sr
(50C)ELLEN HAMMUTIEL CALLEN was born November 24, 1849. She may have married FRED JACKSON (no proof at this time), but another source states that she never married. Ellen died on December 12, 1874 and is buried in Valley Creek Cemetery.

3,42-RICHARD CATER CALLEN/ John K/ John/ William Callen Sr
(50C)RICHARD CATER CALLEN was born on June 3, 1853. He married
1st MARY LOU JACKSON on September 11, 1878, and 2nd TOMMIE HELM LEE
in June 1880, Tommie was born August 12, 1856. Richard died on
February 28, 1913, he and Tommie are buried in the Old Live Oak
Cemetery in Selma, Alabama.

Children of Tommie Lee

- i Cater Callen-
- ii R Raymond Callen-
- iii Lucille Callen-m Mr. HARRELL
- iv Jennie Callen-m Mr. ADAMS
- v Bessie Callen-

3,43-WILLIAM L KIRKPATRICK/ Nancy Callen/ John/ William Callen Sr
(50A)WILLIAM LAIRD KIRKPATRICK was born on February 28, 1848 in
Fort Deposit, Alabama. (50H)On Dec 28, 1870 in Dallas Co, Alabama,
he married CLARA FRANCES RAHAM who was born Sept 11, 1848 in Milton,
Fla. William was a farmer and merchant, Clara was a housewife.

William died September 22, 1923, Clara died on January 24, 1932;
both are buried in the Live Oak Cemetery, Selma, Alabama.

Children

- 3,85 i Ida Bell Kirkpatrick- born & died 1872
- ii Malena Smyley Kirkpatrick-b Jan 9, 1875
- iii Claudia Ione Kirkpatrick-b Jul 8, 1877
- iv Alice Olive Snowden Kirkpatrick-b Jul 6, 1879

3,44-JULIUS A HOOKS/ Dorcas Callen/ John/ William Callen Sr
(50B)JULIUS ALEXANDER HOOKS was born on August 22, 1843 probably
in Mecklenburg, N.C. By occupation he was a farmer. On January 11,
1872 he married MARY ELIZABETH WILHELM who was born December 20,
1852 in Alabama, probably in Wood Cove, Jackson Co.

Mary Elizabeth died January 4, 1916, Julius died December 16, 1924;
both are buried in Lake Creek Cem, Lake Creek, Delta Co, Texas.

Children

- 3,86 i Dezzie Lee Hooks-b Oct 23, 1872
- ii Frances Jane Hooks-b Jul 21, 1875
- iii Farlest Alexander Hooks-b Jul 11, 1878
- iv Dorcus Malinda Hooks-b Feb 12, 1882
- v Julius Leo Hooks-b Jan 7, 1884
- vi John Robert Hooks-b Sept 16, 1886
- vii Mary Olive Hooks-b Jan 6, 1890
- viii Charles Lafayette Hooks-b Mar 11, 1893
- ix Arthur Hooks-b Feb 9, 1896

3,45-HARRIS H CALLEN/ Ellis/ John?/ William Callen Sr
(47)HARRIS H CALLEN was born around 1829-30, the son of (Ellis?)
Callen and Elizabeth Harvey (Kennedy) Callen. (45)"Harris Callen
could not have been more than 16 or 17 years old when he came to

Louisiana on the wagon-train of 1847. The History says 'Harris Callen bought the old Beck place on the high road near Old Pisgah Church. He married a Miss HORN.'

3,46-THOMAS A CALLEN/ William III/ James/ William Callen Sr
(50A-44)Dr THOMAS ARNOLD CALLEN was born April 30, 1818 the son of William Callen III and Sarah "Sallie" (Littleton) Callen. Thomas may have been married twice - one researcher (53E)shows he married MARGARET WILEY - another researcher (53A)shows Thomas married DIANA MILDRED SMITH who was born November 12, 1817 in Hartsville, Tenn. Diana was the daughter of Skelton and Jane Cosby (Yancey) Smith.

Thomas died on April 29, 1856; Diana died May 10, 1892, both died in Columbia, Alabama.

Children

- i Margaret Callen-
- ii Thomas A Callen-
- iii Wiley Callen-
- iv Georgia Ann Callen-
- v Sarah "Sallie" E Callen-b Apr 11 1849 d Feb 12 1927
- 3,87 vi Mary Eliza Callen-b Feb 10, 1851

3,47-MARY CALLEN/ William III/ James/ William Callen Sr
(55E)MARY "POLLY" CALLEN was born around 1820, she was the daughter of William Callen III and Sarah (Littleton) Callen. Polly married WILLIAM CULVERHOUSE on May 19, 1840 in Dallas County, Alabama. She died in 1858, and her husband William died in 1859.

Children

- 3,88 i William Callen Culverhouse-b Jan 31, 1846
(Probable Children - not verified)
- ii Mary Anne Culverhouse-b
- iii Lizzie T Culverhouse-b
- iv John Culverhouse-b
- v Franklin Culverhouse-b
- vi Thomas Culverhouse-b
- vii Georgia Culverhouse-b

3,48-JAMES C CALLEN/ William III/ James/ William Callen Sr
JAMES CICERO CALLEN was born 1838. He married ADA McELWAIN.

will of JAMES CICERO CALLEN
(filed Dallas Co, Alabama on June 22, 1863)

I, James C Callen, of the county of Dallas and the state of Alabama, being of sound mind and disposing memory, and being about to engage in the war between the Confederate States of America and the United States and being unprepared with uncertainty of life, do make and constitute this my last will & testament.

Item 1: I give and bequeath to my sister Lucinda Smith, who now lives in Arkansas for and during the term of her natural life, my negroe girl named Jane, now about 11 years old and at the death of my said sister, I give and bequeath said negroe girl to the issue of the body of my said sister.

Item 2: I give and bequeath to my mother, Sarah O Callen for and during the term of her natural life my negroe girl named Lavinia, about 9 years old. And at the death of my said mother, I give and bequeath to my niece Mary Ann Culverhouse, for and during the term of her natural life the said negroe girl named Lavinia to the issue of the body of the said Mary Ann Culverhouse.

Item 3: All the rest and residue of my property after the payment of my just debts, I give and bequeath to my brothers and sisters except that my sister, Lucinda Smith, and my neice, Mary Ann Culverhouse, in consideration of the specific legacies bequeath to them, are excluded from any share or distribution in the said rest and residue of my estate.

In witness whereof I have hereunto set my hand and office, my said seal, this 29th day of April AD 1861.

J.C. Callen

In the presence of M M Fellows? & J M Haralson

3,49-GEORGE M CALLEN/ William III/ James/ William Callen Sr
GEORGE MARIAN CALLEN was born ca 1841, he was the son of William Callen III.

3,50-JAMES C GEORGE/ Elizabeth Callen/ James/ William Callen Sr
(55F)JAMES CALLEN GEORGE was born on June 16, 1826 in Dallas Co, Alabama, the son of Alexander and Elizabeth (Callen) George. Around 1844 he married LUCINDA HUTCHESON who was born around 1828 in Alabama, the daughter of Hezekiah Hutcheson. Lucinda died between 1880-1890 probably in Texas; James died May 1908 in Seminola, Ok.

Children

- i Adeline Elizabeth George-b Aug 6, 1845
- ii William Andrew George-b Aug 29, 1847 d Dec 28, 1847
- iii Priscila Elizabeth George-b Dec 3, 1848
d May 13, 1855 in Alabama
- iv Alexander Andrew George-b Oct 3, 1851 d Feb 5, 1859
- 3,89 v William Stewart George-b April 13, 1854
- 3,90 vi Hosia Halcum George-b Jan 7, 1857
- vii Georgia Ann George-b Apr 15, 1859 d 1936 in Texas
- viii Margaret Alice George-b Dec 1, 1862 d Aug 31, 1947

3,51-JAMIMA F CHOATE/ Mary Callen/ James/ William Callen Sr
(55D)JAMIMA FRANCIS CHOATE (or CHOAT) was born around 1831 in Dallas Co, Alabama, she was the daughter of William and Mary (Callen) Choat. On May 25, 1847 she married GEORGE W WILLIAMS who was born ca 1822 in North Carolina. George died ca 1869; Jamima died between 1870-1879, both are probably buried in Titus Co, Texas.

Children

- 3,91 i Mary Francis "Molly" Williams-b Oct 17, 1848
ii W.F. Williams-b ca 1852
iii George Walter Williams-b Aug 22, 1855 d Sept 19 1874
iv Augustus Williams-b Aug 12, 1857 d Oct 9, 1860
v Lud Williams-b Mar 12, 1859 d Sept 2, 1864

(55D)"W.F; George; Augustus; and Lud all buried in Slayton Cemetery near Daingerfield, Texas. A marker near above stones reads "J.A.W." Could this be Jamima?"

3,52-FRANCES O MARTIN/ Anna Callen/ James/ William Callen Sr
(50B-53G)FRANCES OLIVIA MARTIN was born on December 31, 1832 in Summerfield, Alabama, she was the daughter of Anna (Callen) and Henry Martin. "Fannie" married THOMAS HENRY AVERYT on December 14, 1852, he was born on November 28, 1832 in Dallas Co, Alabama. Fannie died on September 7, 1880, Thomas died on March 4, 1884, both in Dallas Co, Alabama.

Child

- 3,92 i Thomas Danial Averyt-b Nov 23, 1856

3,53-WILLIAM D CALLEN/ George A/ William Jr/ William Callen Sr
(45-51B)WILLIAM DWIGHT CALLEN was born in Monroe Co, Tenn on December 11, 1836. He was the son of George A and Matilda (Davis) Callen, (59)"both natives of North Carolina". They had "For many years made [their] home near the old Military Road some four miles west of Dardanelle [Arkansas]".

"Before arriving in Arkansas this family had went to Alabama, thence to Mississippi and in 1850 made their permanent home in the old Mt. Zion community.

(45)He "served in the Confederate Army, and was a successful farmer of Yell Co, Ark." (See Goodspeed, West Ark 1891 pg 133).

(52)"William Callan enlisted in Hallowells Company D, 15th Infantry, in 1861 and went with this unit into Missouri where he fought the battles of Oak Hill and later Elk Horn, or Pea Ridge, Farmington, Mississippi, Gibson, Champion Hill and Big Black. He was dispatched to Corinth, Tupelo and Iuka, and took part in the second battle of Corinth, also fighting at Jackson and Vicksburg and on 4 July 1863, he surrendered with the loyal sons of the south when the fort of Vicksburg was forced to surrender because of starvation.

"Upon being paroled and returning to Arkansas he was captured by Capt. Bennett and was practically forced into the Union command, but was not armed when he was captured by the Confederates again and sent to Red River, to join a company of cavalry, with which he served until the surrender.

"Returning home after the war he purchased a farm on Hays Creek west of Dardanelle, and resided there the remainder of his life. In 1867, he married Miss NANCY [JANE] HUFF, daughter of William L and

Frances Huff, formerly of Tennessee but who came to this county in 1848, where their daughter was born in 30 March 1848...

(52)The Callans are parents of 11 children all of which lived until 1890, fact is that the Callans family can boast of a long lived race." (51A)William D died April 12, 1908, Nancy died June 2, 1934; they are both buried in the Mt Zion Cemetery in Dardanelle, Arkansas.

Children

- 3,93 i George Monroe Callan-b Jan 25, 1868
- 3,94 ii Amanda Allie Callan-b May 6, 1870
- 3,95 iii Caroline Donnis Callan-b Dec 4, 1871
- iv Audie Matilda Callan-b Dec 1, 1873
- 3,96 v William Anderson Callan-b Nov 5, 1875
- 3,97 vi Francis Narcis Callan-b Apr 10, 1877
- 3,98 vii Clemmie Price Callan-b Apr 5, 1879
- 3,99 viii Harrison Alexander Callan-b Jan 11, 1881
- 3,100 ix James Burton Callan-b Mar 10, 1883
- 3,101 x Dorcas Orlean Callan-b June 24, 1886
- 3,102 xi Leonard (Gus) Callan-b Aug 2, 1888

(Note - the spelling of the last name of this family has been changed to Callan)

3,54-COLUMBUS CALLEN/ George A/ William Jr/ William Callen Sr
COLUMBUS CALLEN was born (29)ca 1846 in Alabama. (45)He was a farmer "and Postmaster of Delaware, Logan Co., Ark. (See Goodspeed, supra, pg 343.)" He married in 1867 to ELVIRA JOHNSON (29)who was born ca 1845. They are shown on the 1880 census in Logan Co, Ark. Elvira died in 1887.

Children (All born in Arkansas)

- i Cicero Callen-b ca 1868
- ii Eugene Callen-b ca 1870
- iii May M Callen-b ca 1871
- iv Venia Callen(female)-b ca 1873
- v Sarah Callen-b ca 1874
- vi Callie Callen(female)-b ca 1878

3,55-CATHERINE A CALLEN/ George A/ William Jr/ William Callen Sr
CATHERINE A CALLEN (45-51A) "is thought to be a daughter of George A and Matilda (Davis) Callan." Catherine married JAS. H BIGGERS.

Child

- 3,103 i George B Biggers-b 1850

3,56-MARION CALLEN/ Hannibal D/ Thomas/ William Callen Sr?
(60C)MARION CALLEN was the oldest son of Thomas and Jane C (West) Callen. (60H)"Marion went to Civil War from Waco, Texas. He is buried at Headly, Texas."

3,57-SOCRATES P CALLEN/ Hannibal D/ Thomas/ William Callen Sr?

(60I)SOCRATES POLASKY "BIG CRAT" CALLEN was born January 8, 1854 in Carroll Co, Ark. (58)He "was called "Uncle Crat" by many people. He was the son of a Confederate States Civil War veteran. When he was a young boy he moved with his parents, Hanibal Dekalb Callen and Elizabeth Leathers Callen and other members of the family to West Station, Texas, near Waco."

(60I)On December 23, 1877 in West Station Texas Crat married MOLLY WALTER BENNETT who was born in West, Texas in 1860. (58)"Big Crat, Mollie and family moved in a covered wagon from West Station, Texas to Ardmore, Carter County, Indian Territory in March of 1895 and coming on to Wiley, I.T. the same year. They settled about 3 miles Northeast of Wiley and "Crat" named the place Bold Springs after Bold Springs at his old home place in McLennan County, Texas.

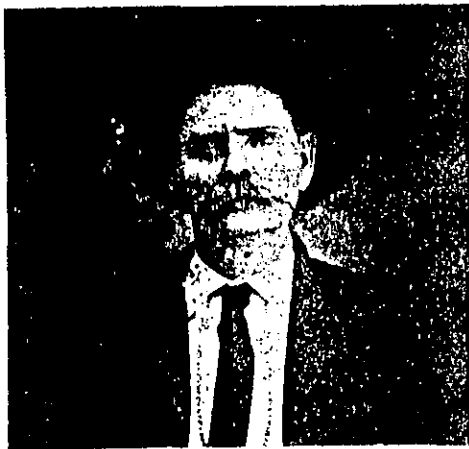

"BIG CRAT" CALLEN

"Shortly after arriving near Wiley, "Crat" wanted more grazing land and he employed an interpreter to help him lease 500 acres of grazing land from the Indian people. Mollie was concerned about a garden for fresh vegetables, but had no seed and didn't know if she could get any in time for the garden. She had been hearing a rooster crowing early every morning and supposed there must be neighbors not too far away. She put on her riding skirt she brought with her from Texas early one morning and saddled up a mule and rode in the direction she heard the rooster. She found the neighbors, they were Indian people, and

the Indian woman gave her enough seed to plant her first garden in Indian Territory.

"After Indian Territory became the state of Oklahoma in 1907, "Crat" was elected (at the first election) as constable of Milburn. Later he was appointed a field man and later jailer under the second sheriff of Johnston County and in 1910, "Crat" and Mollie and family moved to Tishomingo.

"In 1914, "Crat" was elected sheriff of Johnston County and served in that capacity for a term and then as jailer for the next five years. He was a farmer and rancher in the Milburn area for the next several years. In 1931 and 1932 he operated a grocery business in Wiley. The rest of his life was spent in semi-retirement. He died February 28, 1945 at Fillmore at the age of 91 and is buried in the Bold Springs Cemetery near Wiley. Mollie died at the age of 93 in Ada, Oklahoma on December 31, 1953 and is buried at Condon Grove Cemetery at Milburn..."

Children

- 3,104 i Minnie Ola Callen-b Sept 26, 1878
- 3,105 ii Dora Etta Callen-b Nov 18, 1880
- 3,106 iii Henry DeKalb Callen-b Nov 18, 1882
- 3,107 iv Ernest Lonnie Callen-b Dec 12, 1884
- 3,108 v Thomas Knight Callen-b May 19, 1887
- 3,109 vi Jesse James Callen-b Sept 4, 1889
- 3,110 vii Ollie Booker Callen-b July 30, 1891
- 3,111 viii Coy Crat Callen-b Nov 4, 1892
- 3,112 ix Effie Callen-b May 30, 1897
- 3,113 x Essie Callen-b June 27, 1899
- 3,114 xi Clara Callen-b July 31, 1902

3,58-SOCRATES P CALLEN/ Americus V/ Thomas/ William Callen Sr?
 (60C)SOCRATES PLATO CALLEN was born in Carroll Co, Arkansas on January 4, 1864, the son of Americus and Mary (Boyd) Callen. He was a farmer. In January 1894, in Bessie, Oklahoma, Socrates married MARY IDELLA DOWDA. Mary died in 1917, Socrates died Sept 20, 1938; they are buried in the Springhill Cemetery, Mountain Park, Ok.

Children

- i Claud Alva Callen-b Nov 2, 1894
- ii Ralph Bert Callen-b Jan 9, 1897
- iii Marion West Callen-b Feb 9, 1899
- iv Flora Grace Callen-b June 20, 1901
- v Minnie Callen-b June 13, 1903
- 3,115 vi Mack Americus Callen-b June 15, 1905
- vii Effie Lena Callen-b Dec 13, 1907
- viii Crat Thomas Callen-b Nov 4, 1910
- ix James Callen-b Feb 25, 1913

3,59-BUENOS A CALLEN/ Augustus G/ Thomas/ William Callen Sr?
 (60D)BUENOS AYERS CALLEN was born in Farewell, Arkansas on March 11, 1860. He was a farmer/rancher. On August 20, 1882 in Carroll Co, Ark. he married MARY ELIZABETH AMBROSE. Mary was born June 6, 1866 in Kentucky, she was a farm wife. "Boney" died December 5, 1948, Mary died March 8, 1957; they are both buried in Jerome, Id.

Children

- i Rudolph Plato "Dolphe" Callen-b June 8, 1883
- 3,116 ii Roscoe Joseph Callen-b Jan 8, 1884
- iii Zua C Callen-b Nov 3, 1885
- iv Elmer Ellsworth Callen-b Mar 19, 1887
- v Lester Cornelius "Tike" Callen-b Mar 23, 1889
- vi Richard Henry "Dick" Callen-b Feb 2, 1891
- vii Augustus Callen-b Oct 10, 1892
- viii Buenos Marion Callen-b Feb 13, 1896
- ix Blanche Irene Callen-b Sept 13, 1899
- 3,117 x Thomas Callen-b June 3, 1901
- xi Christopher Callen-b Jan 26, 1906
- xii Burton Rudolph Callen-b Dec 24, 1909
- xiii unknown-"perhaps stillborn?"
- xiv unknown-"perhaps stillborn?"

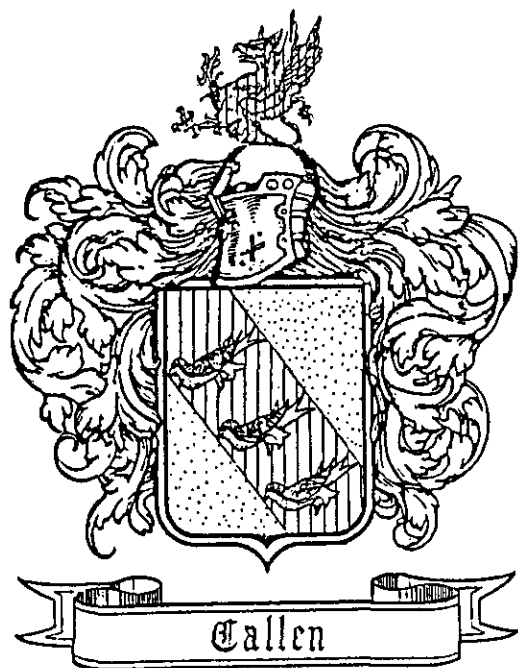

LINE OF WILLIAM CALLEN SR - 5TH GENERATION

3,60-MARTHA PERDUE/ Nancy Kirkpatrick/ Elizabeth Callen/ John/
William Callen Sr

(50A)MARTHA PERDUE was the daughter of Nancy E (Kirkpatrick) and
James H Perdue. She married Mr. DEAN.

Children

(May be partial list)

3,118 1 Tabitha Dean-

3,61-ALEXANDER M KIRKPATRICK/ Samuel A/ Elizabeth Callen/ John/
William Callen Sr

(50I)ALEXANDER M KIRKPATRICK was born July 10, 1840 in Alabama. On
September 12, 1867 he married MARY JANE BLACKWELL. (50A) He was a
private in the Confederate Army, he enlisted May 15, 1862 in La.,
and was listed as a prisoner of war, and was paroled at
Natchitoches La. on June 20, 1865. Alexander died Feb 2, 1898.

3,62-JOHN T KIRKPATRICK/ Samuel A/ Elizabeth Callen/ John/ William
Callen Sr

(50I)JOHN THOMAS KIRKPATRICK "was born February 20, 1846 near
Greenville, Butler Co, Alabama, the son of Samuel Alexander
Kirkpatrick and Sarah E Davis." On October 27, 1867 John married
CAROLINE WILLIAMSON (50G)the marriage being performed by Rev
Franklin. Caroline was the (49)"oldest child of Samuel D and Ann
(Cato) Williamson, [she] was born December 13, 1850 in Monroe
County, Alabama."

(50G)"John T Kirkpatrick served the Confederate States in Courier
Service, Co. B, Birds 1st Battalion, Trans-Mississippi Cavalry.
C.S.A. (see Confederate Pension Records - Louisiana State Archives,
Baton Rouge, La.)"

John died May 20, 1921. Caroline died January 22, 1942. They are
buried in the Fellowship Methodist Church Cemetery, Hinston, La.

Children

3,119 i Louis Van Dorn Kirkpatrick-b Feb 26, 1869
3,120 ii Samuel Augustus Kirkpatrick-b Sept 13, 1870
3,121 iii Eugenia Kirkpatrick-b Nov 28, 1872
iv John Thomas Kirkpatrick-b Jan 18, 1875 Bachelor
3,122 v James Fisher Kirkpatrick-b Oct 30, 1876
3,123 vi Rollie Crittenden Kirkpatrick-b Dec 16, 1878
3,124 vii Margaret "Maude" Kirkpatrick-b Nov 11, 1880
3,125 viii Minnie Maybell Kirkpatrick-b May 30, 1884
3,126 ix Dewitt Talmadge Kirkpatrick-b Feb 29, 1887
3,127 x Jewell Edna Kirkpatrick-b July 21, 1890
3,128 xi Mamie Lee Kirkpatrick-b Feb 28, 1893

3,63-FRANCES KIRKPATRICK/ Samuel A/ Elizabeth Callen/ John/
William Callen Sr

(50A)FRANCES F KIRKPATRICK was born Oct 9, 1850 in Union Parish, Louisiana. She was the daughter of Samuel A and Sarah E (Davis) Kirkpatrick. Around 1871 probably in Vernon Parish, La she married LEMUEL A TINSLEY who was born June 14, 1850 in Ouachita Parish, La, son of Josiah and Catherine (Fuller) Tinsley. Lemuel was a farmer.

(50I)Billy Parker of Simpson, La says, "On Aug 2, 1962 I interviewed Frank Jackson (1879-1964). He once owned a sawmill and stated that he cut the largest pine he had ever seen on the old Lemuel Tinsley place. This happened in the 1920's. The butt cut (14 ft) scaled 8,528 board feet (Doyle scale). On the ground the average man could not reach the top of this Loblolly Pine. Today the Forestry Assoc. crowns trees of each species and if this tree was standing it would be worlds champion Loblolly."

(50A)Lemuel died on July 15, 1901 and is buried in Collins Cemetery, Vernon Parish, La. (50I)Frances spent her latter years living with her daughters Viola and Sarah in Simpson, La. Frances died May 30, 1927 and is buried in Welcome Cemetery, Simpson, Louisiana.

Children

- 3,129 i Mary Augusta Tinsley-b Aug 25, 1872
- 3,130 ii E Viola Tinsley-b Mar 7, 1874
- 3,131 iii Sarah Catherine "Sallie" Tinsley-b Jul 19, 1876
- 3,132 iv Louisiana Bell "Oddy" Tinsley-b Sept 4, 1878
- v James F Tinsley-b Aug 7, 1881 d Feb 4, 1883
- vi Joseph Tinsley-b m ANNIE WILBORN
- vii Charity E Tinsley-b Nov 8, 1886 d Dec 5, 1886
- 3,133 viii George W Tinsley-b July 4, 1891 d Oct 17, 1895

(Note - (50I)James, Charity, and George were all born in Vernon Parish and are buried in Collins Cemetery, Vernon Parish, Louisiana)

3,64-AUGUSTUS C KIRKPATRICK/ Samuel A/ Elizabeth Callen/ John/
William Callen Sr

(50J)AUGUSTUS CRITTENDEN KIRKPATRICK was born in Louisiana on May 31, 1852, the son of Samuel A and Sarah E (Davis) Kirkpatrick. On November 9, 1876 he married LETSY ADARINE HOLTON. Letsy was born Jan 4, 1857 the daughter of William and Izella (Strickland) Holton.

Letsy died on November 11, 1920, Augustus died on May 6, 1935. They are both buried in the Fellowship Cemetery in Hineston, LA.

Children

- 3,134 i Nannie Izella Kirkpatrick-b Aug 14, 1877
- 3,135 ii Robert Pinkney Kirkpatrick-b Apr 11, 1879
- 3,136 iii Willie Augustus Kirkpatrick-b Sept 24, 1880
- 3,137 iv Eugene Emerson Kirkpatrick-b Jan 26, 1882
- 3,138 v Trenton Crittenden Kirkpatrick-b Apr 19, 1883
- 3,139 vi Leah Loucetta Kirkpatrick-b Feb 26, 1885
- 3,140 vii Solomon Edgar Kirkpatrick-b July 3, 1887
- viii Roscoe Kirkpatrick-b Mar 3, 1889 d Aug 28, 1889

3,65-WILLIAM M HORNADY/ Sarah E Kirkpatrick/ Elizabeth Callen/
John/ William Callen Sr

(50A)WILLIAM M HORNADY (HORNADAY) was born March 24, 1862 or 1864,
the son of Sarah E (Kirkpatrick) and William Hornady. He married
IDA CHEATHAM, who was born January 1, 1868. William died January
27, 1930, Ida died July 16, 1959, both are buried in Little Sandy
Ridge Cemetery in Fort Deposit, Lowndes Co, Alabama.

Children

- 3,141 i Henry C Hornady-b Aug 3, 1886
- 3,142 ii Inee Hornady-
- iii Streety Hornady- m MINNIE HUDSON
- iv Lucille Hornady- m HUGH DAVIDSON
- 3,143 v Willie Cliff Hornady-
- vi Hermione Hornady- m JETT THOMAS
- vii Ethel Hornady- m Mr. WINDHAM
- 3,144 viii Bertha Dolly Hornady-b Jan 15, 1906
- ix Theo Hornady- d 1986 buried Little Sandy Ridge C

3,66-JOHNATHAN C KIRKPATRICK/ Valentine/ Elizabeth Callen/ John/
William Callen Sr

(50A)JOHNATHAN CERVANTES KIRKPATRICK was born August 1859 in
Alabama. In 1888 he married ISADORE (Unknown) who was born August
1867. "This info taken from 1900 Butler Co, Al census under name of
Johnny Kirkpatrick."

Children

- i Luther E Kirkpatrick-b July 1889
- ii John C Kirkpatrick-b June 1891
- iii Russell W Kirkpatrick-b Oct 1894
- iv Joe B Kirkpatrick-b Sept 1898

3,67-FRANCIS E KIRKPATRICK/ Valentine/ Elizabeth Callen/ John/
William Callen Sr

(50A)FRANCIS EDWARD KIRKPATRICK was born in Butler Co, Alabama on
January 26, 1866, the son of Valentine and Mary (Bill) Kirkpatrick.
On December 23, 1890, in Butler Co, Ala. he married SAMANTHA WOOD
who was born in Fort Deposit, Ala on January 13, 1874. Samantha was
the daughter of Nancy Hulda (Barganier) and James Green Wood.

Children

- 3,145 i Jessie Kirkpatrick-b Sept 30, 1891
- 3,146 ii Mary Ellen Kirkpatrick-b June 16, 1895

3,68-SAMUEL R PICKENS/ Nancy H Callen/ Ross/ John/ William Callen Sr

(50E)SAMUEL ROSS PICKENS was born around 1852, the son of Nancy (Callen) and Zeno Pickens. He married ALABAMA CAROLINA ZEIGLER, daughter of Rebecca C (Golsan) and Daniel A Ziegler.

Samuel died around 1935, they are both buried in Greenville, Texas.

Children

- 3,147 i Minnie Lou Pickens
- 3,148 ii Sheppard Frank Pickens-
- iii Clyde Elcano Pickens-
- 3,149 iv Aubrey Preston Pickens-b 1885
- 3,150 v Noby Reynolds Pickens-b 1889
- 3,151 vi Pearl Lillian Pickens-b Mar 24, 1890
- 3,152 vii Bessie Rebecca Pickens-
- 3,153 viii Samuel Ross "Bud" Pickens-
- ix Jesse Brooks Pickens- d late 1920's/early 30's
- 3,154 x Connie Agnes Pickens-
- 3,155 xi Bennie Zeno Pickens-
- 3,156 xii Oliver Elmo Pickens-



SAMUEL R AND ALABAMA CAROLINA PICKENS with two of their children



WILLIAM J. F. & MARY EUGENIA (SHEPPARD) GLASS and child

3,69-ROSS C GLASS/ Margaret F Callen/ Ross/ John/ William Callen Sr

(50D)ROSS CALLEN GLASS was born October 4, 1848. On January 21, 1869 he married REBECCA TILLERY. Ross died September 29, 1919 and is buried in the Fort Deposit Cemetery in Alabama.

Children

- i William Oliver Glass-b Nov 29, 1869 d Jul 6, 1870
- 3,157 ii John Leonidas Glass-b June 3, 1871
- 3,158 iii Sturgeon Foster Glass-b Jul 25, 1873
- 3,159 iv James Frances Glass-b Dec 10, 1875
- v Robert Malcolm Glass-b Aug 11, 1878 d Oct 27, 1902
- 3,160 vi Joseph Ross Glass-b Sept 21, 1880
- 3,161 vii Rebecca Arabelle Glass-b Jan 8, 1883
- viii Lucian Presley Glass-b May 22, 1885
- 3,162 ix Garnett Callen Glass-Mar 25, 1888
- 3,163 x Folsom Lamont Glass-b Dec 22, 1892
- 3,164 xi Eva Eulala Glass-b Jul 18, 1895



WILLIAM J F & ROSS C GLASS

3,70-WILLIAM J F GLASS/ Margaret F Callen/ Ross/ John/ William Callen Sr

(50D)WILLIAM JAMES FOSTER GLASS was born on October 17, 1850 in Butler Co, Alabama, he was the son of Robert and Margaret (Callen) Glass. On February 10, 1881 he married MARY EUGENIA REBECCA SHEPPARD who was born on October 23, 1863 in Butler Co. Alabama. Mary died on September 20, 1919, William died on October 10, 1925; they are both buried in Forbis Cemetery in Emory Texas.

Children

- 3,165 i Frederick Elmer Glass-b Dec 1, 1881
- 3,166 ii Clarence Alexander Glass-b Oct 31, 1883
- 3,167 iii Annie Gertrude Glass-b Feb 26, 1886
- 3,168 iv Charles Robert Glass-b Jan 19, 1888
- 3,169 v Mattie Leora Glass-b Aug 29, 1891
- 3,170 vi Velma Sheppard Glass-b Mar 16, 1894
- 3,171 vii Wicker Ira Glass-b Oct 21, 1896
- 3,172 viii William Ralph Glass-b Sept 27, 1898
- 3,173 ix Irene Eugenia Glass-b Aug 3, 1900
- x Ida Evelyn Glass-b Jan 25, 1903 d Oct 12, 1904
buried Forbis Cemetery, Emory, Texas
- 3,174 xi Margaret Louise Glass-b Mar 28, 1909

3,71-OLIVER M GLASS/ Margaret F Callen/ Ross/ John/ William Callen Sr

(50D)OLIVER McKEE GLASS was born February 11, 1853, the son of Margaret (Callen) and Robert W.A. Glass. He died July 17, 1854 and is buried in Little Sandy Ridge Cemetery in Lowndes Co, Alabama.

3,72-JAMES R CALLEN/ John C/ Ross/ John/ William Callen Sr

(50D)JAMES ROBERT CALLEN was born September 11, 1860 in Alabama. On January 25, 1883 he married EMMA V CATES who was born November 4, 1865. James died July 23, 1922, Emma died January 16, 1925; they are both buried in Little Sandy Ridge Cemetery, Lowndes Co, Alabama.

3,73-MARGARET W CALLEN/ John C/ Ross/ John/ William Callen Sr

(50D)MARGARET W CALLEN was born December 15, 1861 in Alabama. She married JOHN F SHULTZ on her 20th birthday, December 15, 1881. Margaret died December 23, 1883 and is buried in Little Sandy Ridge Cemetery, Lowndes Co, Alabama.

3,74-LULA A CALLEN/ John C/ Ross/ John/ William Callen Sr

(50D)LULA A CALLEN was born in 1863. On January 6, 1881 in Fort Deposit, Alabama she married ANDREW J CONWAY. Lula died in 1936 and is buried in Little Sandy Ridge Cemetery, Lowndes Co, Alabama.

3,75-AMANDA CALLEN/ John C/ Ross/ John/ William Callen Sr

(50D)AMANDA CALLEN was born in 1864, the daughter of John C and Rebecca E (Gandy) Callen. On December 12, 1889 she married W. IVY CONWAY. Amanda died in 1940 and is buried in Little Sandy Ridge Cemetery, Lowndes Co, Alabama.

3,76-MARY E CALLEN/ John C/ Ross/ John/ William Callen Sr

(50D)MARY ELLA CALLEN was born March 10, 1866 in Alabama. On January 3, 1884 she married WATSON MATTHEW CATES. Mary died December 30, 1922.

3,77-JOHN H CALLEN/ John C/ Ross/ John/ William Callen Sr

(50D)JOHN H CALLEN was the son of John C and Rebecca E (Gandy) Callen. He was born in Alabama. John married IDA CATES. He is buried in Little Sandy Ridge Cemetery, Lowndes Co, Alabama.

3,78-GEORGIA B CALLEN/ John C/ Ross/ John/ William Callen Sr

(50D)GEORGIA B CALLEN was born April 20, 1871 in Alabama. She married R.E. GANDY on January 19, 1890. Georgia died May 2, 1902 and is buried in Little Sandy Ridge Cemetery, Lowndes Co, Alabama.

3,79-CALLIE CALLEN/ John C/ Ross/ John/ William Callen Sr

(50D)CALLIE CALLEN was born December 14, 1874 in Alabama. On December 9, 1896 she married GEORGE C ALUMS. Callie died October 2, 1946 and is buried in Little Sandy Ridge Cem, Lowndes Co, Alabama.

3,80-ELIZABETH CALLEN/ John C/ Ross/ John/ William Callen Sr

(50D)ELIZABETH CALLEN was born around 1878-1879. on November 28, 1897 in Lowndes Co, Alabama she married BISHOP BARGANIER. They had an infant daughter born January 28, 1884 that died when 3 days old.

3,81-WALTON E CALLEN/ Hamilton H/ John K/ John/ William Callen Sr

(50C)WALTON EUGENE CALLEN was born December 19, 1872. He married MATTIE LESTER ROANE who was born December 28, 1874. Walton died March 21, 1937, Mattie died February 12, 1958, both are buried in the Old Live Oak Cemetery, in Selma, Alabama.

Children

- 3,175 i Margurete Callen-
 ii Archibald Roane Callen-
 iii Walton E Callen Jr "Jack"-

3,82-ADA L CALLEN/ Hamilton H/ John K/ John/ William Callen Sr

(50C)ADA LORAIN CALLEN was born on October 3, 1874 in Summerfield, Dallas Co, Alabama. She married WILLIAM JAMES GILMER who was born in 1866. Ada died of cancer in 1922, William died in 1955; both are buried in the Old Live Oak Cemetery, in Selma, Alabama.

Children

- 3,176 i James M Gilmer Sr-b ca 1900
 ii Eugenia Gilmer-
 iii Harris Lewis Gilmer-
 iv Beatrice Gilmer-
 v Marion D "Pete" Gilmer-

3,83-HAMILTON H CALLEN/ Hamilton H/John K/ John/ William Callen Sr

(50C)HAMILTON HARRIS CALLEN was born on April 27, 1876. He married LUCY WALKER. Hamilton died on February 10, 1926 and is buried in the Old Live Oak Cemetery in Selma, Alabama. Lucy died in the 1960's.

Only Child

- i Virginia Callen-

3,84-EUGENIA F CALLEN/ Hamilton H/ John K/ John/ William Callen Sr
(50C)EUGENIA FLORENCE CALLEN was born on February 10, 1879. She
married EUGENE THEODORE GILMER who was born in 1874. Eugenia died
on October 7, 1928 and is buried in the Old Live Oak Cemetery,
Selma, Alabama. Eugene died in 1945.

Only Child

i Hamilton Harris Gilmer- b Sept 30, 1900
d July 25, 1901

3,85-MALENA S KIRKPATRICK/ William L/ Nancy Callen/ John/ William
Callen Sr

(50A-50H)MALENA SMYLEY KIRKPATRICK was born on January 9, 1875 in
Cahaba, Dallas Co, Ala, she was the daughter of William L and Clara
F (Raham) Kirkpatrick.

On November 21, 1901 in Selma, Alabama Malena married JOSEPH KNIGHT.
Joseph was the son of John T and Missouri (Hutchison) Knight, he was
born on July 19, 1868, in Greenville, Alabama. Joseph was a farmer
and merchant.

Joseph died on July 18, 1832, Malena died on July 21, 1952; both
are buried in Live Oak Cemetery in Selma, Alabama.

Children

3,177 i Claude Kirkpatrick Knight-b Sept 2, 1902
ii Malena Claire Knight-b Apr 12, 1904

3,86-DORCAS M HOOKS/ Julius A/ Dorcus Callen/ John/ William Callen
Sr

(50B)DORCAS MALINDA HOOKS was born February 12, 1881 in Delta Co,
Texas, the daughter of Julius and Mary E (Wilhelm) Hooks. She
married WILLIAM ROBERT MILLS who was born September 13, 1866 in
Boones' Mill, Franklin Co, Va, he was the son of Martha Mills.

Dorcias died December 1, 1968, William died on December 26, 1942;
both are buried in Lake Creek Cem, in Lake Creek, Delta Co, Texas.

Children

(all born Lake Creek, Delta Co, Texas)

i Willie Ross Mills-b Aug 1, 1898
ii Farris Leo Mills-b Jan 12, 1901
iii Effie Ruth Mills-b Jan 26, 1903
iv Dezzie Iona Mills-b Aug 4, 1905
v Jewel Estelle Mills-b Feb 7, 1908
3,178 vi Georgia Mae Mills-b Dec 8, 1910
vii Mary Elizabeth Mills-b Oct 1, 1912
viii Hugh Clarence Mills-b Jan 26, 1915
ix Robert Maurice Mills-b Sept 5, 1917



Purcell home ca 1890
Left to right:
Florrie, Willie,
Clare, Selma,
Mary Eliza, Ruby,
friend, Malcolm,
Wm Henry Purcell



x Julia Pauline Mills-b Jan 7, 1921
xi Wayland Mills-b Dec 22, 1923

3,87-MARY E CALLEN/ Thomas A/ William III/ James/ William Callen Sr

(55A-55B)MARY ELIZA CALLEN was born February 10, 1851 in Henry Co, Alabama. She was the daughter of Thomas A and Diana M (Smith) Callen. On December 11, 1870 in Henry Co, Mary Eliza married WILLIAM HENRY PURCELL. William was born March 20, 1845 in Maxton, Robeson Co, North Carolina, and was the son of Malcolm and Clarkie Sophia (Drake) Purcell.

(53)Mary Eliza "was a woman of remarkable energy and ambition for her children."

(55C)"In their plantation home on the Chattahoochee [River] in Henry County, Al, their first five children were born. By 1882 [William H Purcell] had moved his family to Columbia, a river port 4 miles downstream, where he had a warehouse and drayage business. Here their sixth child was born in 1884. Their new home [see photo] was completed in 1890."

This home is listed as the "Purcell-Killingsworth House" and was placed on the National Register of Historic Places on December 16, 1982. "The house was placed on the National Register based on the political and business career of W.H. Purcell...its historical significance was tied to W.H. Purcell's long residence there... I think (youngest child) Clare Purcell's place in Methodist history was a contributing factor..."

(55A)William died of pneumonia on January 15, 1910, Mary Eliza died October 25, 1929 in Jasper, Ala. Both are buried in Columbia, Ala.

Children

3,179 i Willie Callen Purcell-b 1872
3,180 ii Selma Purcell-b 1874
3,181 iii Ruby Estelle Purcell-b 1876
3,182 iv Thomas Malcolm Purcell-b 1879
3,183 v Florence (Florrie) Purcell-b 1880
3,184 vi Clare Purcell-b Nov 17, 1884

3,88-WILLIAM C CULVERHOUSE/ Mary Callen/ William III/ James/ William Callen Sr

(55E)WILLIAM CALLEN CULVERHOUSE was born on January 31, 1846 in Farmerville, Louisiana. He was the son of William and Mary (Callen) Culverhouse. On November 23, 1880 William married ELIZABETH ELVIRA FAHNESTOCK in Selma, Alabama. Elizabeth died on Nov 23, 1893, William died on January 3, 1901. They are buried in Live Oak Cemetery in Selma, Alabama.

Children

- 3,185 i Eugen Callen Culverhouse-b July 31, 1882
ii Adele Culverhouse-b 1884
iii Gertrude Elizabeth Culverhouse-b ca 1886
iv Harry Hardee Culverhouse-b ca 1888

3,89-WILLIAM S GEORGE/ James C/ Elizabeth Callen/ James/ William Callen Sr

(50B-53H)WILLIAM STEWART GEORGE was born April 13, 1854 in Pleasant Site, Franklin, Ala. On June 1, 1874 he married MARY JANE PIKE who was born January 31, 1856 in Miss. William died on Feb 7, 1936, Mary Jane died March 15, 1948, both died in Seminole, Ok.

Child

- 3,186 i Major Arthur George

3,90-HOSIA H GEORGE/ James C/ Elizabeth Callen/ James/ William Callen Sr

(55F)HOSIA HALCUM GEORGE was born January 7, 1857 in Franklyn Co, Ala. He was the son of James C George and Lucinda (Hutcheson) George. He was a Baptist minister. In 1875 Hosia married AMANDA ELIZABETH GOODWIN who was born in 1860 in Franklyn Co, Ala.

Amanada died ca 1882-84 in Texas. After her death he married again. Hosia died October 3, 1926 and is buried in Hughes, Oklahoma.

Children

- i John Callen George-b Nov 1876 in Ala
ii William Stuart George-b Nov 1878 in Texas
3,187 iii Mary Lucinda George-b July 28, 1882
(+13 more children by his second marriage)

3,91-MARY F WILLIAMS/ Jamima Choate/ Mary Callen/ James/ William Callen Sr

(50B-55D)MARY FRANCIS "MOLLY" WILLIAMS was born on October 17, 1848 in Dallas Co, Alabama, she was the daughter of Jamima (Choate) and George W Williams. On October 22, 1865 Molly married CHARLES EDWARD SLAYTON. Charles was a farmer. By 1879 Mary Francis was the only surviving child of her parents.

Charles died on August 31, 1936; Molly died on January 13, 1900, she has "no marker if buried with husband" in the Slayton Cemetery near Daingerfield, Morris Co, Texas.

Children

- i Infant Slayton-b Oct 7, 1866
ii Augusta Caroline Slayton-b ca 1870
iii Charles Edward Slayton II-b ca 1872
3,188 iv Henry Walter Slayton-b Nov 15, 1874
v Virginia Gertrude Slayton-b July 3, 1876
m Mr. THOMAS

3,92-THOMAS D AVERYT/ Francis M/ Ann Callen/ James/ William Callen Sr

(50B-55G)THOMAS DANIAL AVERYT was born on November 23, 1856 in Dallas Co, Alabama. On October 8, 1878 in Alabama, Thomas married ELLEN "NELLIE" TERESA READ, daughter of Robert J and Ellen Theresa (Deady/Dady) Read. Thomas died on January 12, 1905 near Evergreen, San Jacinto Co, Texas; Nellie died June 29, 1934 in Houston, Harris Co, Texas.

Child

3,189 i Edith Lucile Averyt-b Jan 16, 1897

3,93-GEORGE M CALLAN II/ William D Callen/ George A/ William Jr/ William Callen Sr

(45-51A)GEORGE MONROE CALLAN II was born January 25, 1868 he was the son of William D and Nancy J (Huff) Callen-Callan. (51B)"George was my grandfather and he was called "Roe" by family and friends. He was a carpenter by trade, raised a big garden, had chickens and hogs. At one time he was a beekeeper. He was a strick disciplinarian so I was told, but to me he was a gentle man with dry wit and lots of stories."

(51B)On January 4, 1892 George married KATHERINE A KERSEY who was born July 15, 1875. Kate died September 28, 1901 and is buried in Dardanell, Ark. After her death George married (45)KATE LEEPER who was born ca 1875. "George M... remained in Yell Co, Arkansas."

(51B)"Whenever we went to visit my grandparents, (Katherine Leeper) my grandmother, always made my brother a devil's food cake and would make me an angel food cake which is still my favorite cake. Katherine Leeper and George did not have any children of their own so she raised his three sons as her own."

George died in 1956 and is buried in Dardanelle.

Children

3,190 i Allie Willis Callan-b Mar 4, 1894
3,191 ii Hobart Monroe Callan-b Feb 28, 1896
3,192 iii Everett Dwight Callan-b Dec 28, 1898

3,94-AMANDA A CALLAN/ William D Callen/ George A/ William Jr/ William Callen Sr

(45-51A)AMANDA ALLIE CALLAN was born May 6, 1870. "Alice" married GOODRICH E PILQUIST. "Alice...remained in Yell Co, Arkansas."

Child

i Murel Pilquist- m BUCK CROOM

3,95-CAROLINE D CALLAN/ William D Callen/ George A/ William Jr/
William Callen Sr

(45-51A)CAROLINE DONNIS CALLAN was born December 4, 1871, she
married GEORGE JONES. "Donnie lived in Poteau, Oklahoma."

Children

- i Bentley Jones-
- ii Clara Jones-
- iii Dell Jones-
- iv Syble Jones-

3,96-WILLIAM A CALLAN/ William D Callen/ George A/ William Jr/
William Callen Sr

(45-51A)WILLIAM ANDERSON CALLAN was born November 15, 1875, he
married ASLEE TILLMAN. "Will [lived] in Henrietta, Oklahoma, and
later in Texas." Will died in 1914.

Children

- i Olen Callan-
- ii Marie Callan-
- iii Mildred Callan-

3,97-FRANCIS N CALLAN/ William D Callen/ George A/ William Jr/
William Callen Sr

(45-51A)FRANCIS NARCIS CALLAN was born April 10, 1877, she married
GEORGE GRAY. "Frances [lived] in _____."

Child

- i Vadus Gray-

3,98-CLEMMIE P CALLAN/ William D Callen/ George A/ William Jr/
William Callen Sr

(45-51B)CLEMMIE PRICE CALLAN was born April 5, 1879, he married
RUBY CLINTON. "Clem [lived] in Hot Springs."

Children

- i Elizabeth Callan- m Mr. ELLISON
- ii Frances Callan II- m NOLEN ALLISON
- iii Carolyn Callan-

3,99-HARRISON A CALLAN/ William D Callen/ George A/ William Jr/
William Callen Sr

(45-51B)HARRISON ALEXANDER CALLAN was born January 11, 1881.
(51A)He married first GORDA BIGGERS (believed to be his cousin-see
3,196) and 2nd ROSA PIGEON who was born around 1890. "Harry...
[lived] in Hot Springs."

Children

- 3,193 i Pete G Callan-
 ii A.W.(Allie?) Callan III-b 1920
 iii Dollma J Callan-b 1922 m VIRGIL IRWIN in 1941
 iv L.D. Callan-b 1925 m FRANCES STOVALL in 1945
 v Joann Callan-b 1935 m R.N. BEAVERS

3,100-JAMES B CALLAN/ William D Callen/ George A/ William Jr/
William Callen Sr

(45-51A)JAMES BURTON CALLAN was born March 10, 1883, he married
ETHEL BRAY (52)daughter of David H and Lillie Kersey Bray. (45)"Jas.
[lived] in Ft. Smith, Arkansas" (52)having moved from Dardanelle in
1920, but many is the old timer who remembers when Mr. Callans used
to play a violin at the country parties."

Child

- i Irma Callan-

3,101-DORCAS O CALLAN/ William D Callen/ George A/ William Jr/
William Callen Sr

(45-51A)DORCAS ORLEAN CALLAN was born June 24, 1886, she married
THOMAS McCRAY (52)"of the Chickalah community and lives on the old
family farm to this day."

Children

- 3,194 i Megell McCray-b 1912
3,195 ii John N McCray-b 1916

3,102-LEONARD (GUS) CALLAN/ William D Callen/ Georga A/ William
Jr/ William Callen Sr

(45-51A)LEONARD (GUS) CALLEN was born around 1888, he married
LAVANCHE LEMOYNE. "Gus died in Yell Co, Ark. [in 1925], but
decendants settled in California."

Children

- i Leonard Callan II-
ii Thelma Callan- m HOYLE D BERKHEAD
iii Alfred Callan-
iv Margaret Callan- m Mr. MILLER

3,103-GEORGE B BIGGERS/ Catherine A Callen/ George A/ William Jr/
William Callen Sr

(51A)GEORGE B BIGGERS was born in 1850, the son of Catherine A
(Callen) and Jas H Biggers. In 1873 George married WILLIE A HUFF
who was born in 1855.

Children

- i Maggie Biggers-b 1874
ii Calvin Biggers-b 1878
iii John Biggers- b 1880

- 3,196 iv Gorda Biggers-b 1885
- v Denver Biggers-b 1887
- vi Norma Biggers-b 1892
- vii Frederick Biggers-b 1893
- twin viii Ellwood Biggers-b 1893
- twin ix Cass Biggers-
- x Birdie Biggers-
- xi William Biggers-b 1898

3,104-MINNIE O CALLEN/ Socrates P/ Hanibald D/ Thomas/ William Callen Sr?

(58)MINNIE OLA CALLEN was born September 26, 1878 in West Station, Texas, the daughter of Socrates Polasky and Molly (Bennett) Callen. She never married. Minnie died March 24, 1963 at the Hill Crest home, in Tishomingo, OK. and is buried in the Condon Grove Cemetery, Milburn, Oklahoma.

3,105-DORA E CALLEN/ Socrates P/ Hanibald D/ Thomas/ William Callen Sr?

(58)DORA ETTA CALLEN was born November 18, 1880 in West Station, Texas, the daughter of Socrates Polasky and Molly (Bennett) Callen. In 1897 she married RICHARD "DICK" SNEED. Dora died October 28, 1918 and is buried in Bold Springs Cemetery near Wiley, Oklahoma.

Children

- i Vera Sneed-
- ii Eula Sneed-
- iii Everett Sneed-
- iv Neva Sneed-
- v Ruby Sneed-
- vi Carl Sneed-

3,106-HENRY D CALLEN/ Socrates P/ Hanibald D/ Thomas/ William Callen Sr?

(60I)HENRY DEKALB CALLEN was born November 18, 1882 in West Station, Texas. In Cope, Texas in May of 1904 he married IDA MCKAY, she was born January 2, 1886. Henry was a farmer/rancher, and Ida was a homemaker. Henry died January 19, 1919, Ida died just a few days later on January 31, 1919, the "Callen Family History" says they died of influenza during a flu epidemic; they are buried in Bold Springs, Milburn Co, Oklahoma.

Children

- i Clarence Edward "Jake" Callen-b Apr 25, 1905
- m ORVETTA HOLMES d Oct 17, 1983
- ii Opal Callen-b Mar 20, 1911 d Jan 18, 1919
- 3,197 iii Clinton Woodrow Callen-b Oct 11, 1913
- iv James Socrates "Crat" Callen II-b Aug 5, 1915
- m MILDRED DENNIS d Jul 9, 1961

3,107-EARNEST L CALLEN/ Socrates P/ Hanibald D/ Thomas/ William Callen Sr?

(58)"EARNEST LONNIE CALLEN was born December 12, 1884 at West Station, Texas near Waco, the son of Socrates Polusky "Uncle Crat" and Mollie Bennett Callen. Earnest moved in a covered wagon with his parents from West Station to Carter County, Indian Territory in March of 1895 at the age of 11 years. Coming on to Bold Springs, Indian Territory later the same year. He married IDA GOODMAN, May 4, 1908. Ida died during the flu epidemic, February 14, 1920, at the age of 30 years and is buried at Bold Springs Cemetery. On November 13, 1921, Earnest married EDITH HAMMOND MILLICAN.

"Earnest was a farmer-rancher in the Fillmore area from 1906 to 1940. Earnest and Edith operated a grocery store in Fillmore from 1940 to 1951 when they retired. Edith preceeded him in death May 25, 1956 at the age of 69 years and is buried at Condon Grove Cemetery at Milburn. Earnest died at Fillmore March 17, 1959 at the age of 74 years, also buried at Condon Grove Cemetery..."

Children of Ida

- 3,198 i Ona Callen-
- 3,199 ii Lonnie Callen-
- 3,200 iii Alvie Callen-
- 3,201 iv Theresa Callen-
- 3,202 v Clayton Callen-
- Child of Edith
- 3,203 vi Orelia Callen-

3,108-THOMAS K CALLEN/ Socrates P/ Hanibald D/ Thomas/ William Callen Sr?

(58)"THOMAS KNIGHT CALLEN was born May 19, 1887 at West Station, Texas. He married ANGIE CHANEY on April 26, 1921. Angie was killed in 1926 when a cyclone demolished their home. On April 23, 1935, Tom married IRENE HOLMES." Tom died in 1983.

3,109-JESSE J CALLEN/ Socrates P/ Hanibald D/ Thomas/ William Callen Sr?

(60D-60H)JESSE JAMES CALLEN was born September 4, 1889 in West, Texas. On May 10, 1910 in Milburn, Oklahoma. He married HALLEY GERTRUDE ALLEN. Halley was born in Gainsville, Texas on January 22, 1892. Jesse was a farmer, Halley was a housewife. Jesse died August 30, 1940 and is buried in Bold Springs Cemetery, Milburn, Oklahoma; Halley died June 15 1986 in Mangum, Oklahoma.

Children

- i Alberta Callen- must have died young
- 3,204 ii Casto M Callen-b Sept 30, 1913
- 3,205 iii Roscoe Murlin Callen-b Feb 8, 1916
- iv Arzrow Callen-b June 5, 1920
- v Murray C Callen-b Sept 16, 1922

3,110-OLLIE B CALLEN/ Socrates P/ Hanibald D/ Thomas/ William Callen Sr?

(58)"OLLIE BOOKER CALLEN was born July 30, 1891 at West Station, Texas and married STELLA FRANKS in 1920... Ollie died July 6, 1951 and is buried at Condon Grove Cemetery at Milburn [Oklahoma]."

Only Child

i Sylvia Callen-

3,111-COY C CALLEN/ Socrates/ Hanibald/ Thomas/ William Callen Sr?

(60G)COY CRAT CALLEN was born in West, Texas on November 4, 1892, he was the son of Socates P and Molly (Bennett) Callen. (58)"He came to Johnston County with his family when he was two years old."

On April 13, 1914 in Bentley, Oklahoma he married NANCY IONA HAMILTON who was born in Cooper, Texas on October 25, 1898. Coy was a farmer, "Ona" was a housewife. Between 1922 and 1930 "Coy moved his family to western Oklahoma, Greer County, close to Mangum... In 1954, the family moved to Erick, Okla, Beckham County."

Coy died July 20, 1978 and is buried in Erick, Oklahoma, Ona died January 29, 1990 at the age of ninety one.

Children

1 Jewell Callen-b July 11, 1915 d 1918
3,206 ii Lamoin Coy Callen-b May 2, 1919
iii Thorvell Callen-b Apr 10, 1922 d May 2, 1978
3,207 iv Wanda Marie Callen-b Aug 15, 1930
twin 3,208 v Wilma Dean Callen-b Jan 20, 1939
twin 3,209 vi Norma Jean Callen-b Jan 20, 1939

3,112-EFFIE CALLEN/ Socrates P/ Hanibald D/ Thomas/ William Callen Sr?

(58)"EFFIE CALLEN was born May 30, 1897 at Bold Springs near Wiley, Oklahoma. She married BUD RUTH in 1930 and to her and Bud were born two sons... Bud died about 1961 and she married ARTHUR BEAVERS in 1972..."

Children

i Franklin Ruth-
ii Edward Ruth-

3,113-ESSIE CALLEN/ Socrates P/ Hanibald D/ Thomas/ William Callen Sr?

(58)"ESSIE CALLEN was born June 27, 1899 at Bold Springs and married BOLIE GRISSUM... Essie resided in Atoka, Oklahoma, and died September 3, 1978 and was buried in Tishomingo [Oklahoma]."

Children

i Mary Louise Grissum-
ii Maurice Grissum(female)-

3,114-CLARA CALLEN/ Socrates P/ Hanibald D/ Thomas/ William Callen Sr?

(58)"CLARA CALLEN was born July 31, 1902 at Bold Springs. On December 5, 1919 she married ERVIN CARGILL... Clara now resided in Pleasant Hill, California."

Children

- i Imogene Cargill-
- ii Thelmet Cargill-
- iii Oneta Cargill-
- iv Carole Lee Cargill-
- v David Jasper Cargill-
- vi Joann Cargill-

3,115-MACK A CALLEN/ Socrates P/ Americus V/ Thomas/ William Callen Sr

(60C)MACK AMERICUS CALLEN was born in Bessie, Oklahoma on June 15, 1905. On May 23, 1929 in Lawton, Kansas he married AMY DELORES TUCKER. Amy was born in Lincoln, Kansas on February 24, 1907. Mack was a farmer, Amy is a retired school teacher. Mack died October 25, 1965 and is buried in Mountain Park, Oklahoma.

Children

- i Della June Callen-b June 25, 1931 m Mr. LILES
- ii Wesley Americus Callen-b May 14, 1934
- 3,210 iii Ned Given Callen-b Feb 26, 1936

3,116-ROSCOE J CALLEN/ Buenos A/ Augustus G/ Thomas/ William Callen Sr

(60D)ROSCOE JOSEPH CALLEN was born January 8, 1884 in Farewell, Arkansas. On December 18, 1904 in Galena/Reeds Springs, Missouri he married LOA "MAGGIE" EMERSON. Maggie was born June 20, 1885 in Neodesha, Kansas. Roscoe was a farmer, Maggie was a housewife. Roscoe died September 24, 1936 in Jerome, Idaho.

Children

- 3,211 i Carl Vincent Callen-b Jan 2, 1906
- ii Paul Roscoe Callen-b Apr 25, 1907
- iii Eva Elizabeth Callen-b Mar 15, 1911
- iv Lallah Lillian Callen-b Aug 10, 1916

3,117-THOMAS CALLEN/ Buenos A/ Augustus G/ Thomas/ William Callen Sr

(60D)THOMAS CALLEN was born June 3, 1901 in Galena, Missouri. On May 4. 1921 in Jerome, Idaho he married FERN MARGARET O'HARROW. Fern was born in Nikimi, Wisconsin. Thomas was a farmer and cattle rancher, Fern was a homemaker.

Children

- i Baby Callen-b Oct 1922 stillborn
- ii Blanche Elaine Callen-b Jul 7, 1924 m Mr. PETERS
- iii Gilbert Eldon Callen-b June 19, 1926
- iv Dolphy Ralph Callen-b Dec 18, 1927
- v Tommy Callen-b Apr 29, 1929 (deceased)
- vi Joy Roberta Callen-b Oct 28, 1930 m Mr. STRINGHAM
- 3,212 vii Jerry Ray Callen, Sr-b Feb 27, 1932

LINE OF WILLIAM CALLEN SR - 6TH GENERATION

3,118-TABITHA DEAN/ Martha Perdue/ Nancy Kirkpatrick/ Elizabeth Callen/ John/ William Callen Sr
(50F)TABITHA DEAN was the daughter of Martha (Perdue) Dean. She married Mr. LIGHTSEY.

Children (May be partial list)
i William Lightsey- had daughter SANDRA KAY LIGHTSEY

3,119-LOUIS V KIRKPATRICK/ John T/ Samuel A/ Elizabeth Callen/ John/ William Callen Sr
(49)"LOUIS VAN DORN KIRKPATRICK, oldest child of John and Caroline (Williamson) Kirkpatrick, was born February 26, 1869 in Vernon Parish. He married LYDIA TOLBERT (50G)[sister to W Oliver Tolbert-see 3,121] on September 15, 1899 and there was no issue. Lydia Kirkpatrick was born March 24, 1872 and died September 24, 1959. Louis Kirkpatrick died December 14, 1914. They are buried in Fellowship Cemetery, Hineston."

3,120-SAMUEL A KIRKPATRICK/ John T/ Samuel A/ Elizabeth Callen/ John/ William Callen Sr
(49)"SAMUEL AUGUSTUS KIRKPATRICK, second child of John and Caroline (Williamson) Kirkpatrick, was born September 13, 1870 in Vernon Parish. He married SARAH E CRANFORD on December 29, 1896 and one son was born. Samuel Kirkpatrick died April 15, 1946 and is buried in Oakland Cemetery, Hampton, Virginia. Sarah Kirkpatrick died June 13, 1921 and is buried in Fellowship Cemetery, Hineston."

Only Child

3,213 i Davidson Kerr Kirkpatrick-b Sept 25, 1901

3,121-EUGENIA KIRKPATRICK/ John T/ Samuel A/ Elizabeth Callen/ John/ William Callen Sr
(49)"EUGENIA KIRKPATRICK, third child of John and Caroline (Williamson) Kirkpatrick, was born November 28, 1872 in Vernon Parish. She married WILLIAM OLIVER TOLBERT (50G)[brother of Lydia Tolbert-see 3,119] on March 23, 1895 and four children were born. William Tolbert was born October 19, 1870 and died April 7, 1958. Eugenia Tolbert died September 9, 1943. They are buried in Fellowship Cemetery, Hineston."

Children

i Douglas Malcom Tolbert-b June 23, 1896
m KATIE LEE DAVIS
ii Grace Tolbert-b Aug 17, 1898 d May 28, 1926
m Mr. HODGES
iii Roy Tolbert-b Apr 7, 1901 m JENNIE BLACKWELL
iv John Alton Tolbert-b Aug 10, 1904 m ESSIE WILSON

3,122-JAMES F KIRKPATRICK/ John T/ Samuel A/ Elizabeth Callen/
John/ William Callen Sr

(49)"JAMES FISHER KIRKPATRICK, fifth child of John and Caroline (Williamson) Kirkpatrick, was born October 30, 1876 in Vernon Parish. He married MINNIE EDNA HOLTON on January 4, 1905 and one child was born. Minnie Kirkpatrick was born May 4, 1882 and died April 19, 1970. They are both buried in the Leesville Cemetery, Leesville, Louisiana."

Only Child

i Thelma Ione Kirkpatrick-b Jan 11, 1906
d Feb 9, 1965 buried Leesville Cemetery

3,123-ROLLIE C KIRKPATRICK/ John T/ Samuel A/ Elizabeth Callen/
John/ William Callen Sr

(49)"ROLLIE CRITTENDEN KIRKPATRICK, sixth child of John and Caroline (Williamson) Kirkpatrick, was born December 16, 1878 in Hineston, Louisiana. He married JANE MINERVA PIERCE (50G)[sister of Prentiss Pierce-see 3,124] on June 6, 1911 and four children were born. Jane Kirkpatrick was born June 28, 1886 and died May 13, 1931. Rollie Kirkpatrick died March 16, 1940. They are buried in Fellowship Cemetery, Hineston."

Children

3,214 i Ella Maude Kirkpatrick-b Feb 4, 1912
3,215 ii Raleigh Crittenden Kirkpatrick-b Mar 23, 1914
3,216 iii Caroline Jane Kirkpatrick-b July 13, 1917
3,217 iv Rodney Harold Kirkpatrick-b Feb 4, 1919

3,124-MARGARET KIRKPATRICK/ John T/ Samuel A/ Elizabeth Callen/
John/ William Callen Sr

(49)"MARGARET "MAUDE" KIRKPATRICK, seventh child of John and Caroline (Williamson) Kirkpatrick, was born November 11, 1880 in Simpson, Louisiana. She married PRENTISS L PIERCE (50G)[brother of Jane Pierce-see 3,123] on September 13, 1905 and there was no issue. Prentiss Pierce was born August 4, 1881 and died July 28, 1929.

"Maude Pierce died September 16, 1971. They are buried in Fellowship Cemetery, Hineston. Although there was no issue of this marriage, the Pierces did raise the young child of Maude's sister, when Mamie Kirkpatrick King died. The little girl was named John Winifred King."

3,125-MINNIE M KIRKPATRICK/ John T/ Samuel A/ Elizabeth Callen/
John/ William Callen Sr

(49)"MINNIE MAYBELLE KIRKPATRICK eighth child of John and Caroline (Williamson) Kirkpatrick, was born May 30, 1884 in Simpson. She married LUTHER B DOVE and one son was born. Minnie Dove died April 26, 1949 and is buried in Fellowship Cemetery, Hineston."

Only Child

i Murray M Dove-b Sept 1, 1914 m ELMA MCGILVRAY

3,126-DEWITT T KIRKPATRICK/ John T/ Samuel A/ Elizabeth Callen/
John/ William Callen Sr

(49)"DEWITT TALMADGE KIRKPATRICK, ninth child of John and Caroline (Williamson) Kirkpatrick, was born February 29, 1887. He married MINNIE HONEYCUTT, and there was no known issue. Minnie Kirkpatrick was born August 26, 1917. Dewitt Kirkpatrick died June 26, 1968.

3,127-JEWELL E KIRKPATRICK/ John T/ Samuel A/ Elizabeth Callen/
John/ William Callen Sr

(49)"JEWELL EDNA KIRKPATRICK, tenth child of John and Caroline (Williamson) Kirkpatrick, was born July 21, 1890, in Hineston [Louisiana]." (50G)She married BARNIE HADEN EVERSULL on October 14, 1909 in Alexandria, La. The wedding was performed by Rev. Alexander. Barnie was the "son of William F and Ruthanne Amanda (O'Quin) Eversull, [he] was born April 2, 1880 in Will (formerly Natchitoches) Parish, La."

Jewell died March 13, 1955, Barnie died March 24, 1957; both are buried in Greenwood Cemetery, Pineville, Louisiana.

Children

3,218 i Virgie Lee Eversull-b July 23, 1910
3,219 ii Beverly Hayden Eversull-b Sept 21, 1911

3,128-MAMIE L KIRKPATRICK/ John T/ Samuel A/ Elizabeth Callen/
John/ William Callen Sr

(49)"MAMIE LEE KIRKPATRICK, youngest child of John and Caroline (Williamson) Kirkpatrick, was born February 28, 1893 in Hineston, Louisiana. She married JOHN WILLIAM KING on June 7, 1920 and one daughter was born. Mamie King died December 8, 1922" (50A)in childbirth. She is buried in Fellowship Cemetery, Hineston.

Only Childn

i John Winifred King (female)-b Dec 1922
m JOSEPH AUGUSTA MITCHELL - 4 daughters

3,129-MARY A TINSLEY/ Frances A Kirkpatrick/ Samuel A/ Elizabeth Callen/ John/ William Callen Sr

(50I)MARY AUGUSTA "MOLLY" TINSLEY was born on August 25, 1872 in Vernon Parish, La, she was the daughter of Lemuel A and Frances (Kirkpatrick) Tinsley. On December 22, 1892 she married HENRY THORNTON BROWN. (50F)Thornton was born September 1866 in Hattiesburg, Miss. He was the son of William Thornton and Sarah Ann (Sims) Brown.

(50I)Mary died on October 6, 1913 and is buried in Ebenezer Cemetery in Hicks, Louisiana. (50F)Thornton died December 30, 1928 in Bogabusa, La and is buried in the Old Bogabusa (Pone Mah) Cemetery.

Children

- 3,220 i John Samuel Brown-b May 30, 1894
- 3,221 ii Patrick H Brown-b Feb 18, 1896
- 3,222 iii Sarah F Brown-b Feb 8, 1898
- 3,223 iv William T Brown-b Feb 1899

3,130-E VIOLA TINSLEY/ Frances A Kirkpatrick/ Samuel A/ Elizabeth Callen/ John/ William Callen Sr

(49)E VIOLA TINSLEY was born on March 7, 1874 in Vernon Parish, La; she was the daughter of Lemuel A and Frances (Kirkpatrick) Tinsley. (49-50I)On November 7, 1894, in a double ceremony with her sister Sallie, she married DANIEL R WILLIAMSON (born March 15, 1872) the brother of Sallie's husband. (49)"One son was born to this union, and a daughter was adopted." Viola died on April 10, 1917, Daniel died on April 8, 1930; they are both buried in Welcome Cemetery, Simpson, Louisiana.

Children

- 3,224 i Joe Williamson-b 1893
- ii Arlene Williamson (adopted)-d about 8 yrs old

3,131-SARAH C TINSLEY/ Frances A Kirkpatrick/ Samuel A/ Elizabeth Callen/ John/ William Callen Sr

(50A)SARAH CATHERINE "SALLIE" TINSLEY was born on June 19, 1876 in Vernon Parish, Louisiana, she was the daughter of Lemuel A and Frances A (Kirkpatrick) Tinsley. Sallie was the second wife of ELIJAH WILLIAMSON. They were married on November 7, 1894, in Vernon Parish, (49)in a double wedding ceremony with her sister Viola who married Elijah's brother Daniel.

Elijah the (49)"oldest child of Samuel and Nancy (Mason) Williamson, was born March 16, 1870 in Louisiana. He married first MARY M DENNIS on December 17, 1891 in Vernon Parish. Mary Williamson was born in 1874 and died in 1892, at the age of 18 in childbirth. A young infant is buried beside her in Pine Island Cemetery, Simpson."

Sallie was a housewife, Elijah was a farmer and "In the early days had a contract to bring mail from Walnut Hill to Simpson, which he did by horseback and was paid fifty cents per weekly delivery. Elijah died August 24, 1958, Sallie died December 23, 1961 in Port Arthur, Texas. Both are buried in Pine Island Cem, Simpson, La.



SALLIE (TINSLEY) & ELIJAH WILLIAMSON

Children

- 3,225 i George Lemuel Williamson-b Nov 8, 1895
 3,226 ii Rufus Samuel Williamson-b Jul 14, 1897
 3,227 iii Eugene Larkin Williamson-b Apr 6, 1899
 3,228 iv Frances Effie Williamson-b Nov 4, 1900
 v Eunice P Williamson-b Mar 24, 1903 d Apr 24, 1926
 3,229 vi Charley Edgar Williamson-b Mar 3, 1905
 3,230 vii Bertha Naomi Williamson-b Mar 1, 1907
 3,231 viii Eula Dove Williamson-b Jan 4, 1909
 3,232 ix Leon Borden Williamson-b Feb 10, 1912

3,132-LOUISIANA TINSLEY/ Frances A Kirkpatrick/ Samuel A/
 Elizabeth Callen/ John/ William Callen Sr

(50I)LOUISIANA BELL "ODDY" TINSLEY was born on September 4, 1878 in Vernon Parish, Louisiana; she was the daughter of Lemuel A and Frances (Kirkpatrick) Tinsley. Louisiana married WILLIAM HENRY HICKS on September 12, 1894. "There was a double wedding in the Tinsley [family] on Nov. 7, 1894 as two Tinsley sisters married two Williamson brothers. A triple wedding had been talked about but Louisiana Bell and Henry Hicks jumped the gun and married in Sept..."

3,133-GEORGE W TINSLEY/ Frances A Kirkpatrick/ Samuel A/ Elizabeth Callen/ John/ William Callen Sr

(50I)GEORGE W TINSLEY was born on July 4, 1891 in Vernon Parish, Louisiana, the son of Lemuel A and Frances (Kirkpatrick) Tinsley.

"George W died in an accident. He and several other children were playing in the cotton crib where cotton was kept until it was taken to the gin. A large hole was hallowed out in the center of the pile. George went in head first and the sides caved in on him. By the time one of his playmates went to get help he had suffocated." George died on October 17, 1895, aged 4 years old, he is buried in the Collins Cemetery, Slagle, Louisiana.

3,134-NANCY I KIRKPATRICK/ Augustus C/ Samuel A/ Elizabeth Callen/
 John/ William Callen Sr

(50A)NANCY "NANNIE" IZALLA KIRKPATRICK was born August 14, 1877, the daughter of Augustus C and Letsy A (Holton) Kirkpatrick. In March of 1906 she married JOHN W CRANFORD. Nannie died February 10, 1937.

3,135-ROBERT P KIRKPATRICK/ Augustus C/ Samuel A/ Elizabeth Callen/ John/ William Callen Sr

(50A)ROBERT PINKNEY KIRKPATRICK was born April 11, 1879, the son of Augustus C and Letsy A (Holton) Kirkpatrick. On November 21, 1926 he married JULIA LENORA ROW. Robert died November 3, 1950.

3,136-WILLIAM A KIRKPATRICK/ Augustus C/ Samuel A/ Elizabeth Callen/ John/ William Callen Sr
(50A)WILLIAM "WILLIE" AUGUSTUS KIRKPATRICK was born September 24, 1880, he was the son of Augustus C and Letsy A (Holton) Kirkpatrick. In 1916 he married MINNIE BOYD of California. Minnie died in 1928, he married a 2nd time. Willie died August 30, 1956.

3,137-EUGENE E KIRKPATRICK/ Augustus C/ Samuel A/ Elizabeth Callen/ John/ William Callen Sr
(50A)EUGENE EMERSON (or EMERSON EUGENE) KIRKPATRICK was born January 26, 1882, the son of Augustus C and Letsy A (Holton) Kirkpatrick. On July 4, 1906 he married ARLIE GILL. Eugene died February 15, 1956.

3,138-TRENTON C KIRKPATRICK/ Augustus C/ Samuel A/ Elizabeth Callen/ John/ William Callen Sr
(50A)TRENTON CRITTENDEN KIRKPATRICK was born April 19, 1883, the son of Augustus C and Letsy A (Holton) Kirkpatrick. On August 19, 1906 he married LUCY MOORE CARRUTH. Lucy died February 7, 1933. He married a second time to IRMA H LARRAIMER in July 1934. Trenton died April 14, 1960.

3,139-LEAH L KIRKPATRICK/ Augustus C/ Samuel A/ Elizabeth Callen/ John/ William Callen Sr
(50A)LEAH LOUCETTA KIRKPATRICK was born February 26, 1885, the daughter of Augustus C and Letsy A (Holton) Kirkpatrick. She died July 9, 1902.

3,140-SOLOMON E KIRKPATRICK/ Augustus C/ Samuel A/ Elizabeth Callen/ John/ William Callen Sr
(50J)SOLOMON EDGAR KIRKPATRICK was born on July 3, 1887 in Walnut Hill, Vernon Parish, Louisiana. He was the son of Augustus C and Letsy A (Holton) Kirkpatrick. On October 1, 1913 he married CARRIE OPHELIA (or OLIEVIA) ASHMORE. Carrie was born November 12, 1890 in Glenmora, Rapids Parish, Louisiana, the daughter of Emilie (Melder) and John Tuck Ashmore.

Solomon died March 24, 1955, Carrie died February 18, 1966, both are buried in Roselawn Cemetery, Glenmora, Louisiana.

Children

- i Pauline Kirkpatrick-b July 26, 1914 d Apr 25 1988
- 3,233 ii Vonnie V Kirkpatrick-b Jan 9, 1917
- 3,234 iii Gladys Lucille Kirkpatrick-b Apr 1, 1919
- 3,235 iv John Tuck Kirkpatrick-b Apr 30, 1921
- 3,236 v Juanita Kirkpatrick-b Dec 13, 1922
- 3,237 vi Solomon Edgar Kirkpatrick, Jr-b Mar 2, 1926
- 3,238 vii Pattie Ruth Kirkpatrick-b Jan 7, 1931

3,141-HENRY C HORNADY/ William M/ Sarah E Kirkpatrick/ Elizabeth Callen/ John/ William Callen Sr

(50A)HENRY C HORNADY was born in Lowndes Co, Alabama on August 3, 1886, the son of William M and Ida (Cheatham) Hornady. He was a private in M G Co. 322nd Infantry. He died November 4, 1918 and is buried in Little Sandy Ridge Cemetery, Fort Deposit, Alabama.

3,142-INEE HORNADY/ William M/ Sarah E Kirkpatrick/ Elizabeth Callen/ John/ William Callen Sr

(50A)INEE HORNADY was the daughter of William M and Ida (Cheatham) Hornady. She married W.L. BOWEN.

Children (May be partial list)

1 Evelyn Nesbett Bowen-b Jan 24, 1917 d Oct 18 1921

3,143-WILLIE C HORNADY/ William M/ Sarah E Kirkpatrick/ Elizabeth Callen/ John/ William Callen Sr

(50A)WILLIE CLIFF HORNADY was the son of William M and Ida (Cheatham) Hornady.

Children

1 Willie Cliff Hornady, Jr-
11 Jack Hornady-

3,144-BERTHA D HORNADY/ William M/ Sarah E Kirkpatrick/ Elizabeth Callen/ John/ William Callen Sr

(50A)BERTHA DOLLY HORNADY was born January 15, 1906, the daughter of William M and Ida (Cheatham) Hornady. She married F HINDS JONES. Bertha died June 2, 1927 and is buried in Little Sandy Ridge Cemetery, Fort Depost, Alabama.

3,145-JESSIE KIRKPATRICK/ Francis E/ Valentine/ Elizabeth Callen/ John/ William Callen Sr

(50A)JESSIE KIRKPATRICK was born in Georgiana, Butler Co, Alabama on September 30, 1891. She was the daughter of Francis E and Samantha (Wood) Kirkpatrick. On October 18, 1912 she married WILLIAM WALLACE PETTIS.

3,146-MARY E KIRKPATRICK/ Francis E/ Valentine/ Elizabeth Callen/ John/ William Callen Sr

(50A)MARY ELLEN KIRKPATRICK was born June 16, 1895 in Georgiana, Butler Co, Alabama. She was the daughter of Francis E and Samantha (Wood) Kirkpatrick. On May 1, 1922 she married BASIL WATSON.

3,147-MINNIE L PICKENS/ Samuel R/ Nancy H Callen/ Ross/ John/
William Callen Sr

(50E)MINNIE LOU PICKENS was the daughter of Samuel R and Alabama C
(Zeigler) Pickens. She married Mr SANDERS.

Children

- i Raymond Sanders-
- ii Gladys Sanders- m OTIS THRELKELD
- iii Howard Sanders-
- iv Vivian Sanders- m Mr LEMON

3,148-SHEPPARD F PICKENS/ Samuel R/ Nancy H Callen/ Ross/ John/
William Callen Sr

(50E)SHEPPARD FRANK PICKENS was the son of Samuel R and Alabama C
(Zeigler) Pickens. He married BERTHA HOWELL.

Only Child

- i Howell Frank Pickens-

3,149-AUBREY P PICKENS/ Samuel R/ Nancy H Callen/ Ross/ John/
William Callen Sr

(50E)AUBREY PRESTON PICKENS was born in 1885, the son of Samuel R
and Alabama (Zeigler) Pickens. He married TESSIE MORRIS. Aubrey
died in 1940 and is buried in East Mount Cemetery, Greenville, Tx.

Children

- i Bama Pickens-
- ii Peggy Pickens-

3,150-NOBY R PICKENS/ Samuel R/ Nancy H Callen/ Ross/ John/
William Callen Sr

(50E)NOBY REYNOLDS PICKENS was born in 1889, the son of Samuel R
and Alabama (Zeigler) Pickens. He never married. He died in 1966
and is buried in the East Mount Cemetery, Greenville, Texas.

3,151-PEARL L PICKENS/ Samuel R/ Nancy H Callen/ Ross/ John/
William Callen Sr

(50E)PEARL LILLIAN PICKENS was born March 24, 1890, the daughter
of Samuel R and Alabama (Zeigler) Pickens. In 1915 she married W.H.
"BILL" HUFFMAN. Bill died in 1952, Pearl died in 1964, she is
buried in East Mount Cemetery, Greenville, Texas.

Only Child

- i Oliver Ross Huffman-b 1920 d 1965
buried E Mount Cemetery

3,152-BESSIE R PICKENS/ Samuel R/ Nancy H Callen/ Ross/ John/
William Callen Sr

(50E)BESSIE REBECCA PICKENS was the daughter of Samuel R and
Alabama (Zeigler) Pickens. She married first to TAYLOR GUICE. After
the death of Taylor she married Mr. FREY who died before 1966.

Only Child
3,239 i Taylor Guice, Jr-

3,153-SAMUEL R PICKENS/ Samuel R/ Nancy H Callen/ Ross/ John/
William Callen Sr
(50E)SAMUEL "BUD" ROSS PICKENS was the son of Samuel R and Alabama
(Zeigler) Pickens. He married ANNIE DOWNING.

Children
i Christine Pickens-
ii Nell Pickens-
iii Rozelle Pickens-

3,154-CONNIE A PICKENS/ Samuel R/ Nancy H Callen/ Ross/ John/
William Callen Sr
(50E)CONNIE AGNES PICKENS was the daughter of Samuel R and Alabama
(Zeigler) Pickens. She married Mr ANDERSON.

Only Child
i Nell Anderson-

3,155-BENNIE Z PICKENS/ Samuel R/ Nancy H Callen/ Ross/ John/
William Callen Sr
(50E)BENNIE ZENO PICKENS was the son of Samuel R and Alabama
(Zeigler) Pickens. He died before 1966. He was survived by a wife
and one child, their names are not known at this time.

3,156-OLIVER E PICKENS/ Samuel R/ Nancy H Callen/ Ross/ John/
William Callen Sr
(50E)OLIVER ELMO PICKENS was the son of Samuel R and Alabama
(Zeigler) Pickens. He married NOTA SHEPPARD. They had no children.

3,157-JOHN L GLASS/ Ross C/ Margaret F Callen/ Ross/ John/
William Callen Sr
(50E)JOHN LEONIDAS GLASS was born June 3, 1871, the son of Ross C
and Rebecca (Tillery) Glass. John married EFFIE GOLSON. John died
January 16, 1929.

Children
3,240 i Rena Leigh Glass-b Dec 3, 1894
ii Johnnie L Glass-b Oct 20, 1920

3,158-STURGEON F GLASS/ Ross C/ Margaret F Callen/ Ross/ John/
William Callen Sr
(50E)STURGEON FOSTER GLASS was born July 25, 1873, the son of Ross
C and Rebecca (Tillery) Glass. On December 30, 1908 he married
JULIA BELL. Sturgeon died November 12, 1954.

Children

- i Sturgeon Foster Glass-b Oct 3, 1913
m ORIN McLEOD on Jan 26, 1940
- ii Robert Julius Glass-b Sept 23, 1918
m EILEEN KELLY on June 15, 1946
- iii Vincent Bell Glass-b Aug 23, 1920
m EILEEN SPILLER on July 2, 1939
- 3,241 iv Betty Sue Glass-b May 9, 1922

3,159-JAMES F GLASS/ Ross C/ Margaret F Callen/ Ross/ John/
William Callen Sr

(50E)JAMES FRANCES GLASS was born December 10, 1875, the son of
Ross C and Rebecca (Tillery) Glass. On November 26, 1901 he married
LOYD B WOOD. James died May 20, 1934.

Children

- 3,242 i James Malcolm Glass-b Nov 7, 1902
- 3,243 ii Eugenia Ellen Glass-b Aug 7, 1905
- iii William Ross Glass-b Mar 15, 1910
m FRANCES TAYLOR on Jul 13, 1936
- iv Nodie Rebecca Glass-b Feb 14, 1914

3,160-JOSEPH R GLASS/ Ross C/ Margaret F Callen/ Ross/ John/
William Callen Sr

(50E)JOSEPH ROSS GLASS was born September 21, 1880, the son of
Ross C and Rebecca (Tillery) Glass. On January 26, 1903 he married
CLAUDE L GRANT.

Children

- i Albert Ross Glass-b May 21, 1913
m MINNIE MAE GARRETT
- ii Joseph Edward Glass-b Nov 26, 1915
m DOROTHY HOLLAND
- 3,244 iii Robert Malcolm Glass-b Oct 12, 1921

3,161-REBECCA A GLASS/ Ross C/ Margaret F Callen/ Ross/ John/
William Callen Sr

(50E)REBECCA ARABELLE GLASS was born January 8, 1883, the daughter
of Ross C and Rebecca (Tillery) Glass. On January 15, 1908 she
married PERCY HOLMES PRESLEY. Rebecca died January 22, 1972.

Children

- 3,245 i Malcolm Holmes Presley-b Jan 3, 1909
- 3,246 ii Gertrude Rebecca Presley-b Jan 6, 1911

3,162-GARNETT C GLASS/ Ross C/ Margaret F Callen/ Ross/ John/
William Callen Sr

(50E)GARNETT CALLEN GLASS was born March 25, 1888, the son of
Ross C and Rebecca (Tillery) Glass. In April of 1913 he married
VELA OLIVE. Garnett died November 1, 1945.

Children

- i Georgia Louise Glass-b Jan 28, 1914
m FELIX CREIGHTON
- ii Rebecca Eleanor Glass-b Sept 21, 1915
m GRAHAM FLUKER
- iii Garnett Callen Glass-b Nov 7, 1919
- iv William Oscar Mulkey Glass-b Dec 27, 1924

3,163-FOLSOM L GLASS/ Ross C/ Margaret F Callen/ Ross/ John/
William Callen Sr

(50E)FOLSOM LAMONT GLASS was born December 22, 1892, the son of
Ross C and Rebecca (Tillery) Glass. On November 14, 1917 he
married LILLIE KERN. Folsom died August 2, 1969.

Children

- 3,247 i Elaine Glass-b Nov 27, 1921
- 3,248 ii Floretta Glass-b Nov 24, 1926

3,164-EVA E GLASS/ Ross C/ Margaret F Callen/ Ross/ John/ William
Callen Sr

(50E)EVA EULALA GLASS was born July 18, 1895, the daughter of
Ross C and Rebecca (Tillery) Glass. On June 29, 1916 she married
CLIFFORD C COOK. Clifford died January 10, 1963, Eva died November
1, 1975.

Children

- 3,249 i Clifford Marguerite Cook-b Aug 10, 1919

3,165-FREDERICK E GLASS/ William J F/ Margaret F Callen/ Ross/
John/ William Callen Sr

(50E)FREDERICK ELMER GLASS was born on December 1, 1881 in Butler
Co., Alabama. On September 1, 1909 he married EMMA WILLIAMS. Fred
died of typhoid fever on October 15, 1909, just 45 days after his
marriage; he is buried in City Cemetery, Emory, Texas. After
Fred's death, Emma married a man named Furlong and had four children
by him. She died in White Rock, Texas in the late 1940's.

3,166-CLARENCE A GLASS/ William J F/ Margaret F Callen/ Ross/
John/ William Callen Sr

(50D)CLARENCE ALEXANDER GLASS was born on October 31, 1883, in
Butler Co, Alabama. On April 27, 1909 he married RAY ETTER who was
born on August 3, 1888. Clarence died on December 8, 1916, he was
killed by a bank robber, Ray died September 4, 1977; both are
buried in Lone Oak, Texas.

Only Child

- 3,250 i Birdie Loraine Glass-b Jan 14 1914

3,167-ANNIE G GLASS/ William J F/ Margaret F Callen/ Ross/ John/
William Callen Sr

(50D)ANNIE GERTRUDE GLASS was born on February 26, 1886 in Hunt
Co, Texas. On February 26, 1906 she married MERTON E TATMAN, who
disappeared after the deaths of his wife and children. Annie died
on July 27, 1914 and is buried in City Cemetery, Emory, Texas.

Children

- i Alma Rae Tatman-b Nov 25, 1906 d Oct 17, 1918
- ii Howard Lewis Tatman "Sonny Boy"-b Oct 12, 1908
d April 22, 1912
- iii Billy Charles Tatman-b Feb 23, 1914 d May 26 1914

3,168-CHARLES R GLASS/ William J F/ Margaret F Callen/ Ross/ John/
William Callen Sr

(50D)CHARLES ROBERT GLASS was born on January 29, 1888 in Hunt Co,
Texas. On January 11, 1914 he married MARY EULA MORGAN who was born
on July 31, 1890. Charles died in Houston, Texas on July 31, 1960
and is buried in Garden Park Cemetery, Conroe, Texas; Eula died on
October 28, 1970.

Children

- 3,251 i Dorothy Dale Glass-b Nov 26, 1914
- 3,252 ii Mary Alice Glass-b Dec 3, 1920
- 3,253 iii Charles Norwood Glass-b Feb 13, 1923
- 3,254 iv Linda Lou Glass-b Mar 8, 1930

3,169-MATTIE L GLASS/ William J F/ Margaret F Callen/ Ross/ John/
William Callen Sr

(50D)MATTIE LEORA GLASS was born on August 19, 1891 in Hunt Co,
Texas. On November 8, 1914 she married CHARLES AUGUSTUS NICELY who
was born on December 15, 1886. Mattie died on January 31, 1919 in
Watsontown, Penna, and is buried there. Charles died on January 23,
1976.

Only Child

- 3,255 i Mary Jane Nicely-b July 27, 1917

3,170-VELMA S GLASS/ William J F/ Margaret F Callen/ Ross/ John/
William Callen Sr

(50D)VELMA SHEPPARD GLASS was born on March 16, 1894. On May 8,
1916 she married CHARLES BENJAMIN CHAMBERS who was born on March 29,
1891. Velma died on September 8, 1976 and is buried in Garden Park
Cemetery, Conroe, Texas. Charles died November 25, 1982.

Children

- 3,256 i Billie Bob Chambers-b Apr 14, 1917
- ii Martha Gene Chambers-b Oct 5, 1919
- 3,257 iii Joe Charles Chambers-b Jan 30, 1922

3,171-WICKER I GLASS/ William J F/ Margaret F Callen/ Ross/ John/
William Callen Sr

(50D)WICKER IRA GLASS was born on October 21, 1896 in Hunt Co,
Texas, he was the son of William and Mary (Sheppard) Glass. On
December 20, 1919 he married STELLA ARBOREE AMIS, who was born
February 22, 1897. Wicker died on August 21, 1957 and is buried in
City Cemetery, Bryan, Texas.

Children

3,258 i Rebecca Carolyn Glass-b Feb 6, 1921
3,259 ii Joe Louis Glass-b Aug 10, 1928

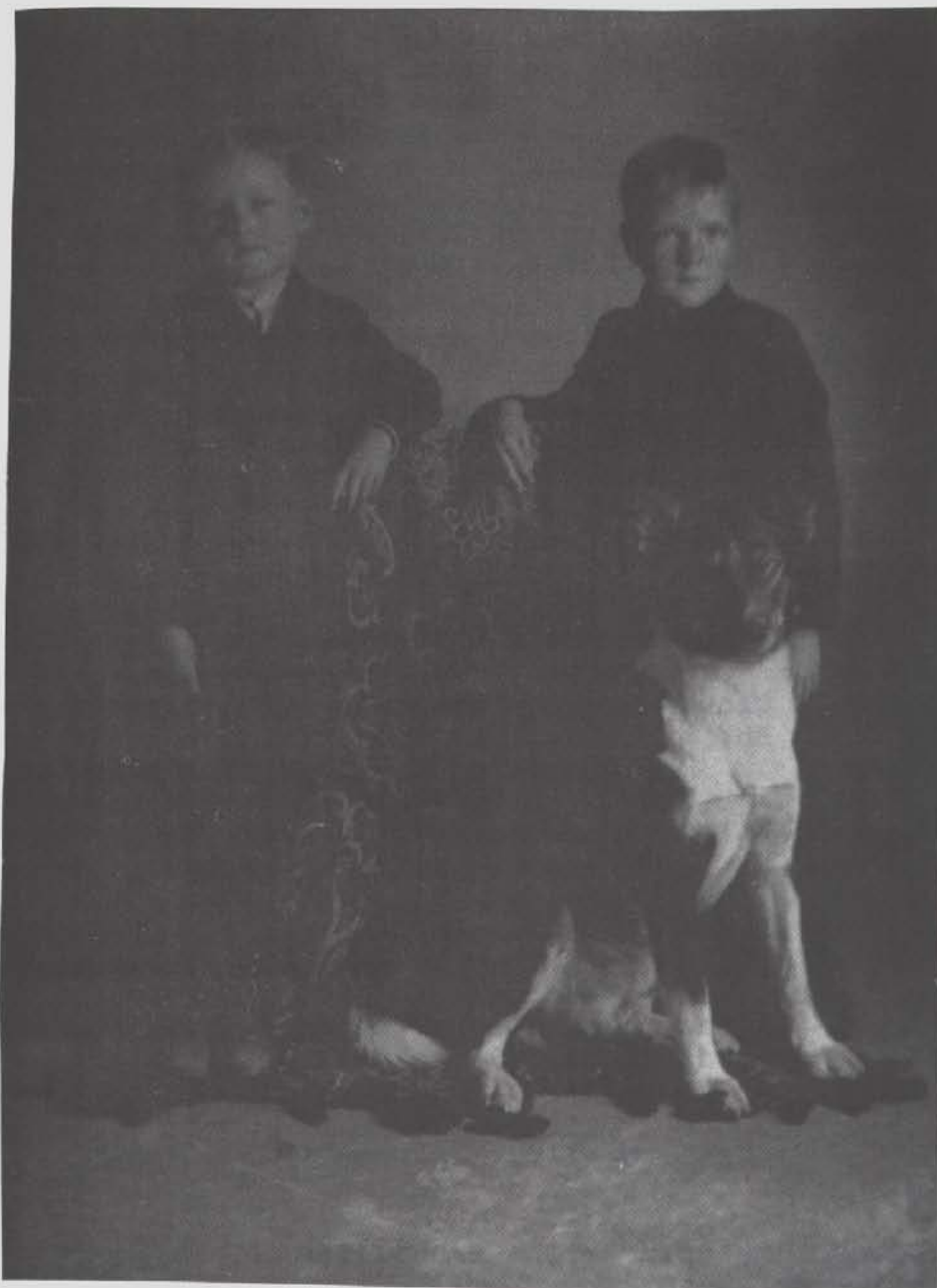

WICKER IRA & WILLIAM RALPH GLASS
with Shep

3,172-WILLIAM R GLASS/ William J F/ Margaret F Callen/ Ross/ John/
William Callen Sr

(50D)WILLIAM RALPH GLASS was born on September 27, 1898 in Hunt
Co, Texas. On Nov 1, 1919 he married MINNIE MAGILENE BETTS who was
born on May 1, 1898. William died on November 6, 1983, Minnie died
on April 4, 1989; both are buried in Pilgrim Rest, Rains Co, Texas.

Only Child

3,260 i Tommie Earl Glass-b July 20, 1920

3,173-IRENE E GLASS/ William J F/ Margaret F Callen/ Ross/ John/
William Callen Sr

(50D)IRENE EUGENIA GLASS was born on August 3, 1900 in Rains Co,
Texas. On December 5, 1919 she married HORACE ERWIN WOODSON who was
born on August 28, 1897. Irene died on March 20, 1972 and is buried
in Porter Road Cemetery, Conroe, Texas, Erwin died on October 31,
1980.

Only Child

3,261 i Harriett Sue Woodson-b Jan 28, 1921

3,174-MARGARET L GLASS/ William J F/ Margaret F Callen/ Ross/
John/ William Callen Sr

(50D)MARGARET LOUISE "LADY" GLASS was born March 28, 1909 in Rains
Co, Texas. On June 16, 1950 she married PETER HERMAN STRAUSS who
was born on September 3, 1910. Peter died April 11, 1965. Margaret
has helped with information in this chapter, and has supplied most
of the pictures for this family line.

3,175-MARGURETE CALLEN/ Walton E/ Hamilton H/ John K/ John/
William Callen Sr

(50C)MARGURETE CALLEN was the daughter of Walton E and Mattie
(Roane) Callen. She married LLOYD REAVIS.

Only Child

i Lloyd Reavis Jr-

3,176-JAMES M GILMER SR/ Ada L Callen/ Hamilton H/ John K/ John/
William Callen Sr

(50C)JAMES M GILMER SR was born ca 1900, the son of Ada Lorain
(Callen) and William James Gilbert. James married MARIE who was
born ca 1895, Marie died July 1988 almost 90 years of age.

Children

3,262 i James M Gilmer Jr-b Sept 21, 1927

3,177-CLAUDE K KNIGHT/ Malena S/ William L/ Nancy Callen/ John/
William Callen Sr

(50A-50H)CLAUDE KIRKPATRICK KNIGHT was born September 2, 1902 in
Selma, Alabama, the son of Joseph and Malena (Kirkpatrick) Knight.
On June 4, 1927 Claude married CLARA IDA WILLIAMS, who was born

February 23, 1904 in Selma. Clara is the daughter of Arthur and Mary (Jones) Williams, she is a medical secretary; Claude was an accountant.

Claude died on March 22, 1944 and is buried in Live Oak Cemetery in Selma, Alabama.

Child

3,263 i Claude Kirkpatrick Knight, Jr-b Oct 31, 1930
ii Joseph Sturdevant Knight-b Aug 29, 1932

3,178-GEORGIA M MILLS/ Dorcus M Hooks/ Julius A/ Dorcas Callen/
John/ William Callen Sr

(50B)GEORGIA MAE MILLS was born December 8, 1910 in Lake Creek, Delta Co, Texas, the daughter of Dorcas M (Hooks) and William Robert Mills. Georgia married WILLIAM AUSTIN GRIZZLE twice - on July 2, 1931 in Hugo, Oklahoma, and again on June 30, 1939 in Delta Co, Texas. William was born January 8, 1912 in Tira, Texas and worked on road construction. Georgia is a retired insurance underwriter and typist.

William died February 25, 1984 and is buried in Oaklawn Cemetery, Cooper, Delta Co, Texas. Georgia is living in Houston, Texas.

Children

(all born in Lake Creek, Delta Co, Texas)
3,264 i Martha Augusta Grizzle-b July 4, 1933
ii Harriett Malinda Grizzle-b Jan 10, 1941
iii Gene Austin Grizzle-b Mar 8, 1942
iv Jerry Garland Grizzle-b Jun 26, 1943
v Danny George Grizzle-b May 4, 1945
vi Randy Joe Grizzle-b July 24, 1948

3,179-WILLIE C PURCELL/ Mary E Callen/ Thomas A/ William III/
James/ William Callen Sr

(55A)WILLIE CALLEN PURCELL was born July 11, 1872. (53)"She graduated from the Alabama Conference Female College (now Huntingdon College). She has a voice remarkable for its compass and sweetness." (53A)On August 28, 1901 she married THOMAS EUGENE MURPHREE who was born in 1859. Thomas died in 1944 and Willie died in 1958.

Children

3,265 i Ethel Claire Murphree-b Dec 6, 1902
3,266 ii Ruth Purcell Murphree-b July 21, 1905
3,267 iii Allie Carroll Murphree-b Dec 31, 1907

3,180-SELMA PURCELL/ Mary E Callen/ Thomas A/ William III/ James/
William Callen Sr

(55A)SELMA PURCELL was born October 10, 1874. (53)"She was graduated from Isabell College, Talledega, Alabama. She has taught for a number of years quite successfully." (55A)On January 5, 1898 she married JOHN DANIEL ABERNATHY who was born in 1870. (53)"He is

a graduate in law of the University of Virginia.". John died in 1948 and Selma died in 1949.

Children

3,268 i Mildred Callen Abernathy-b Sept 21, 1898
3,269 ii John Daniel Abernathy, Jr-b Oct 24, 1904

3,181-RUBY E PURCELL/ Mary E Callen/ Thomas A/ William III/ James/ William Callen Sr

(55A)RUBY ESTELLE PURCELL was born August 16, 1876. (53)"She graduated at Huntingdon College, Montgomery, Alabama. She later took the A.B. Degree at Peabody College, Nashville, Tenn." She taught at Baldwin Junior High School, Montgomery, Ala.

(55A)On June 30,1896 she married JOHN FLOYD COLLINS who was born in 1853. (53)"He was a brilliant man and a consecrated Christian. He was a graduate of Union University, Jackson, Tenn." John died September 15, 1932, Ruby died in 1967.

Children

3,270 i John Floyd Collins, Jr-b July 16, 1897
3,271 ii Meredith Purcell Collins-b July 30, 1899
3,272 iii Milton Massey Collins-b Mar 1, 1901
3,273 iv William Bruce Collins-b Dec 28, 1911

3,182-THOMAS M PURCELL/ Mary E Callen/ Thomas A/ William III/ James/ William Callen Sr

(55A)THOMAS MALCOLM PURCELL was born March 30, 1879. (53)"In 1903 he graduated with an A.B. Degree from Southern University, Greensboro, Ala, now Birmingham-Southern. He has done graduate work at the University of Georgia and Emory University, Atlanta, Ga. completing his M.A. from the latter (1940)." He was superintendent of schools at Cochran, Ga. He enjoyed family research.

(55A)On November 15, 1910 he married MYRTLE MAE DAVIS who was born in 1890. (53)"She is an unusually attractive woman and makes a lovely Christian home for her husband and children." Thomas died in 1961 and Myrtle died in 1978.

Children

3,274 i Thelma Byrnece Purcell-b May 3, 1912
3,275 ii Thomas Malcolm Purcell Jr-b May 9, 1915

3,183-FLORENCE PURCELL/ Mary E Callen/ Thomas A/ William III/ James/ William Callen Sr

(55A)FLORENCE "FLORRIE" PURCELL was born December 6, 1880. (53)"In 1898 she graduated at Huntingdon College. She was a musician." On Dec 27, 1911 she married WALLACE P LONG. Florrie died Jan 14, 1917.

Only Child

i Florence Purcell Long-b Feb 19, 1913 d 1913

3,184-CLARE PURCELL/ Mary E Callen/ Thomas A/ William III/ James/
William Callen Sr

(55A)CLARENCE "CLARE" PURCELL was born November 17, 1884 in Columbia, Alabama. (53)"He is a graduate of Birmingham-Southern College, and also the Theological Department of Vanderbilt University, Nashville, Tenn... He served as Chaplain during the World War, in the A.E.F. in France. He has been a popular preacher and pastor of the Alabama Conference of the Methodist Episcopal Church. He has served some of the most prominent pulpits of that conference... He was Presiding Elder of the Jasper District and was pastor of the First Methodist Church of Gadsden for nine years.



BISHOP CLARE PURCELL

"Clare Purcell has stood out as a strong leader in the Methodist Church. He has been placed on a number of the most important committees in the life of the church. At the 1938 General Conference of Methodist Episcopal Church, South, he was chosen as Bishop and was ordained at Birmingham, Ala., on May 4, 1938...

"Bishop Clare Purcell has made an impression both upon the ministry and the membership of the Methodist Church by his humility, fairness, stability, and spirituality. The people and the ministry believe that he has the deepest interest of the church at heart..."

(55A)On December 28, 1910 in Roanoke, Alabama he married IDA BERNICE WEST who was born July 22, 1887 in Wedowee, Alabama. Ida was the daughter of Robert T and Willie L (Wood) West. (94)"Ida West is in every way fitted to be the wife of a man who is in such a place of leadership as is Clare Purcell. She came from a family of refinement and culture and the Purcell connection is fortunate to have her in it."

(55A)Clare died on February 8, 1964, Ida died January 27, 1967, both buried in Birmingham, Alabama.

Children

- 3,276 i William Wood Rowe Purcell-b Dec 19, 1911
- 3,277 ii John Robert Purcell-b 1915
- 3,278 iii Ida Claire Purcell-b 1921

3,185-EUGEN C CULVERHOUSE/ William C Culverhouse/ Mary Callen/
William III/ James/ William Callen Sr

(55E)EUGEN CALLEN CULVERHOUSE was born on July 31, 1882 in Selma, Alabama. He was the son of William Callen Culverhouse and Elizabeth Elvira (Fahnestock) Culverhouse. Eugen married ALICE ELIZABETH DENNARD. Alice died in 1887, Eugen died on July 16, 1945.

Children

- i Frances Eugenia Culverhouse-b 1906
- ii Edward Gamble Culverhouse-b
- 3,279 iii Allen D Culverhouse-b 1911
- iv Grace Culverhouse-b

3,186-ARTHUR GEORGE/ William S/ James C/ Elizabeth Callen/ James/
William Callen Sr

(50B-55H)MAJOR ARTHUR GEORGE was born on July 26, 1884 in Prentiss Co, Mississippi. On May 15, 1906 he married CARRIE EULA EDINGTON who was born on June 16, 1890 in Lawrence Co, Ark. Carrie was the daughter of James F and Edith E (Milligan) Edington. Carrie died on May 30, 1956 in Caddo, Bryan Co; Arthur died on November 21, 1976 in Durant, Bryan Co, Oklahoma.

Child

- 3,280 i Muriel Marie George-b Feb 6, 1914

3,187-MARY L GEORGE/ Hosia H/ James C/ Elizabeth Callen/ James/
William Callen Sr

(55F)MARY LUCINDA GEORGE was born on July 28, 1882 in Texas. On October 22, 1899 in Hill Co, Texas, she married WILLIAM HENRY HARRISON who was born January 10, 1874 in Lexington Alabama. Mary was a housewife and mother. Mary died October 18, 1931 and is buried in Fisher Co, Texas; William died June 28, 1949 and is buried in Causey, Roosevelt Co, New Mexico.

Children

- i William Clarence Harrison-b Mar 30, 1901 in Okla
- ii James Luther Harrison-b Mar 36, 1903
- iii John Louis Harrison-b May 29, 1905
- 3,281 iv Gladys Elizabeth Harrison-b May 14, 1907
- v Zelma Lucinda Harrison-b Feb 15, 1909
- vi Carl Frederick Harrison-b June 4, 1911
- vii Noel Winfred Harrison-b July 24, 1913 in Okla
- viii Bessie Mae Harrison-b Nov 18, 1915 in Texas
- ix Lola Wilma Harrison-b Nov 14, 1917
- x Clyde Millard Harrison-b May 27, 1921 in Texas

3,188-HENRY W SLAYTON/ Mary F Williams/ Jamima F Choate/ Mary
Callen/ James/ William Callen Sr

(55D)HENRY WALTER SLAYTON was born in Madison Co, Tennessee on November 15, 1874, the son of Charles E and Mary F (Williams). Henry was a farmer. On February 25, 1897 in Daingerfield, Morris Co, Texas Henry married SUSAN ELIZABETH TRUITT who was born on October 4, 1880 in Morris Co, Texas. Henry died on July 18, 1933; Susan died February 18, 1970 in Greenwood, Texas.

Children

- 3,282 i Henry Clifton Slayton-b Jan 6, 1898
 ii Annie Louella Slayton-b Aug 6, 1900 m Mr. WILSON
 iii Cleotus "Skinny" Slayton-b Dec 8, 1902
 iv Beulah Mae Slayton-b Jul 2, 1905 m Mr. PRUITT
 v Charlie Wingate Slayton-b Jul 5, 1907
 vi Mary Ethel Slayton-b Mar 20, 1912 m Mr. BIBBS

3,189-EDITH L AVERYT/ Thomas D/ Francis Martin/ Ann Callen/ James/
William Callen Sr

(50B-55G)EDITH LUCILE AVERYT was born on January 16, 1897 in
Evergreen, San Jacinto Co, Texas. On June 3, 1918, in Texas Edith
married BURRELL "BURL" BYRD PERRY the son of Burrell Bird and
Margaret Bird (Mullins) Perry.

Child

- 3,283 i Elsie Lucile Perry-b May 5, 1923

3,190-ALLIE W CALLAN/ George M II/ William D Callen/ George A/
William Jr/ William Callen Sr

(51B)ALLIE WILLIS CALLAN SR was born March 4, 1894. "Allie was my
father, who was called either Bill or Willis by family and friends.
He was only 5'4" tall but was a man's man." On August 9, 1919 he
married EUNICE EVALINE HARMON who was born October 29, 1899.

"He was a carpenter by trade and built several of the beautiful
homes here in Fort Smith and remodeled several homes and
businesses. He was well-known and respected for his work. He made
a lot of beautiful furniture for his home.

"He loved to fish and hunt but in the last few years of his life, he
had to give up his hobbies because of crippling arthritis.

"He served as a sargeant in the Arkansas National Guard from
Dardanelle on the Mexican Border chasing Pancho Villa. He joined in
World War I and was stationed in France and served as a sargeant
there. One of his favorite stories was that one night his
lieutenant told him that he and his men were to guard this train
which was very important. So they stood guard all night believing
the train was probably loaded with guns and ammo. The next morning
the three cars were unloaded and revealed cases of Hersey chocolate
bars. As he said, they were appreciated more than guns and ammo.

"He became very crippled and walked with a cane but very seldom did
you ever hear him complain. He still drove his car until his death
at age of 90 - almost 91." Allie died December 6, 1984 and is
buried in Brearly Cemetery, Dardanelle, Arkansas; Eunice is still
living in Arkansas.

Children

- 3,284 i Allie Willis Callan Jr-b Nov 24, 1921
3,285 ii Mary Katherine Callan-b Sept 18, 1929

3,191-HOBART M CALLAN/ George M II/ William D Callen/ George A/
William Jr/ William Callen Sr
(51B)HOBART MONROE CALLAN was born February 28, 1896. He married
NEVA HANES. Hobart died in 1964.

3,192-EVERETT D CALLAN/ George M II/ William D Callen/ George A/
William Jr/ William Callen Sr
(51B)EVERETT D CALLAN was born December 28, 1898, he married
ZANTHIA LEMOYNE who was born in 1905. Zanthia died in 1979, Everett
died in 1989.

Children

3,286 i Everett D Callan II-b 1930
3,287 ii Nancy A Callan-

3,193-A.W. CALLAN/ Harry A/ William D Callen/ George A/ William
Jr/ William Callen Sr
(51A)A.W. CALLAN (ALLIE?) was born in 1920. In 1941 he married
BILLIE B LANHAM.

Children

twin? i Donald P Callan (Dr.)-b 1943
m 1st VIVIAN WADSWORTH-b 1941
2nd NANCY SCHULMAR-b 1955
twin? ii Ronald W Callan-b 1943 m ESTHER SNOW-b 1944
iii Elizabeth A Callan-b 1945 m THOMAS INGLING-b 1944

3,194-MEGELL McCRAY/ Orlean Callan/ William D Callen/ George A/
William Jr/ William Callen Sr
(51A)MEGELL McCRAY was born around 1912. In 1938 she married R.E.
WARREN who was born ca 1913.

Child

3,288 i Juna K Warren- 1946

3,195-JOHN N McCRAY/ Orlean Callan/ William D Callen/ George A/
William Jr/ William Callen Sr
(51A)JOHN N McCRAY was born in 1916. He married ODEL V HASTON who
was born in 1920 and died in 1978.

Children

3,289 i Judith A McCray-b 1940
3,290 ii Linda J McCray-b 1947

3,196-GORDA BIGGERS/ George B/ Catherine A Callen/ George A/
William Jr/ William Callen Sr
(51A)GORDA BIGGERS was born around 1885. She married HARRY A
CALLAN who is believed to be her cousin (see 3,99).

3,197-CLINTON W CALLEN/ Henry D/ Socrates P/ Hannibal D/ Thomas/
William Callen Sr?

(60I)CLINTON WOODROW CALLEN was born October 11, 1914 in Bold Springs Community. Clint's parents both died in 1919 during an influenza epidemic, and (54)"Clint and his two brothers Jake and Crat were raised by relatives until their teens when they began farming on their own."

(60I)On December 4, 1932 in Fillmore, Oklahoma he married LUELLA MAE DARBISON who was born in Caddo, Oklahoma on November 19, 1917. She was the daughter of Henry and Ella (Compton) Darbison. (58)"Her family lived in the Milburn area nearly all their lives, and both her parents are buried in the Condon Grove Cemetery east of Milburn.

"Clint and Luella made their home on the old Callen homeplace and purchased other lands nearby to make a farm large enough to support them. They farmed the land, primarily raising peanuts and four children...

"Clinton Woodrow Callen suffered a heart attack and died September 12, 1970 at his home on the old Callen farm at Bold Springs. He was buried in the Condon Grove Cemetery. Clint was very well liked and respected by the community, as evidenced by his funeral which was one of the largest in Milburn history. Clint's friends who attended came from all walks of life, and included Senators, Respresentatives, indian people, black people, the rich, the poor; all mourned in his passing.

"Luella Callen sold the farm to her youngest son Jackie and moved to Durant. Later she met and married Ray Tussy, on January 10, 1973. Ray had also been recently widowed. He and Luella presently live in Durant."

Children

3,291 i Leo Laroice Callen-b Sept 17, 1933
3,292 ii Glenda Jacquita Callen-b Dec 4 1934
3,293 iii Jackie Lynn Callen-b Nov 14, 1938
3,294 iv Judy Mae Callen-b Aug 22, 1942

3,198-ONA CALLEN/ Ernest L/ Socrates P/ Hannibal D/ Thomas/
William Callen Sr?

(58)"ONA CALLEN married BLUFFORD JOHNSON, August 31, 1931. They now reside at Coleman, Oklahoma..."

Children

i Gypsy Lee Johnson- deceased
ii Tanya Johnson- deceased
3,295 iii Randel Johnson-

3,199-LONNIE E CALLEN/ Ernest L/ Socrates P/ Hannibal D/ Thomas/
William Callen Sr?

(59)"LONNIE EDWARD CALLEN, son of Earnest and Ida (Goodman) Callen, was married to ANNA JUANITA HART, daughter of Richard S and Frankie (Frazier) Hart on June 10, 1933.

"Lonnie graduated from Fillmore High School in 1930. He then attended Murray State School of Agriculture and received a 5 year teaching certificate. He completed a BS degree in Education from Southeastern State University. He later obtained a Master's Degree in Public School Administration.

"His teaching career spans 41 years, all of which was completed in Johnston County. These years include: one year at Nida as High School Principal, four years at Enterprise as Principal, 26 years at Fillmore, serving as Principal 23 of these years, and 10 years at Milburn as Superintendent of Schools. He retired in 1975.

"Along with his teaching responsibilities, he served as an insurance agent with Farmers Union Insurance Company for 38 years. Throughout these years he was able to be of service to numerous farm families and individuals in supplying their insurance needs.

"Juanita graduated from Fillmore High School in 1933. Her young adult life was spent as a loving and caring wife and mother. After the children were grown she contributed her skill to nursing care at Johnston Memorial Hospital. Throughout her entire life she has been very active in church work at the Fillmore Church of the Nazarene. Thirty of these years she served as church pianist. She also served as church secretary, N.Y.P.S. Youth Director, Sunday School Teacher, and several other positions which were necessary to the operation of the church..."

Children

3,296 i Joye Jean Callen-b Feb 28, 1935
3,297 ii Dale Callen-b Dec 31, 1942

3,200-ALVIE CALLEN/ Ernest L/ Socrates P/ Hannibal D/ Thomas/
William Callen Sr?

(58)"ALVIE CALLEN married LENA LOWERY September 28, 1931... Alvie died in Oklahoma City, September 11, 1975 and is buried at Condon Grove Cemetery."

Children

3,298 i Margie Callen-
3,299 ii Larry Callen-

3,201-THERESA CALLEN/ Ernest L/ Socrates P/ Hannibal D/ Thomas/
William Callen Sr?

(58)"THERESA CALLEN married CLAUD LAWLEY, October 16, 1932. They now reside in Tishomingo..."

Children

3,300 i Patsy Lawley-
3,301 ii Gary Lawley-
3,302 iii Jerry Lawley-

3,202-CLAYTON CALLEN/ Ernest L/ Socrates P/ Hannibal D/ Thomas/
William Callen Sr?

(58)"CLAYTON CALLEN married CHESTINA SMITH September 16, 1940.
They reside in Oxnard, California..."

Children

3,303 i Clayton Callen Jr-
3,304 ii Novita Callen-
3,305 iii Oneca Callen-

3,203-ORELIA CALLEN/ Ernest L/ Socrates P/ Hannibal D/ Thomas/
William Callen Sr?

(58)"ORELIA CALLEN married MARVIN REED December 21, 1941. They
now reside in Fillmore..."

Only Child

3,306 i Don Reed-

3,204-CASTO M CALLEN/ Jessie J/ Socrates P/ Hannibal D/ Thomas/
William Callen Sr?

(60H)CASTO MERVIN CALLEN was born September 30, 1913 in Milburn,
Oklahoma. He is a farmer by trade. On July 24, 1943 in Los
Angeles, California, he married VERA PAULINE AMICK. Vera was born
September 3, 1923 in DuBois, Pa. Vera is a homemaker. They live in
Magnum, Oklahoma.

Children

i Ralph E Callen-b Nov 4, 1935
ii Dewain M Callen-b Dec 6, 1936
iii Dale C Callen-b Jan 12, 1944
iv Ronnie L Callen-b Nov 7, 1947
v Jim P Callen-b Aug 10, 1949
vi Jannett Callen-b Sept 10, 1951 m Mr. TROSPER
vii Hal R Callen-b July 2, 1953

3,205-ROSCOE M CALLEN/ Jesse J/ Socrates P/ Hannibal D/ Thomas/
William Callen Sr?

(60F)ROSCOE "ROCK" MURLIN CALLEN was born February 8, 1916 in
Milburn, Oklahoma. On May 10, 1986 in Jerome, Idaho he married
BARBARA JACQUELYN VAN ORNUM who was born in Pasadena California on
October 25, 1932. They have no children. Roscoe is a rancher,
Barbara is a housewife.

3,206-LAMOIN C CALLEN/ Coy C/ Socrates P/ Hannibal D/ Thomas/
William Callen Sr?

(60G)LAMOIN COY CALLEN was born in Fort Smith, Arkansas on May 2,
1919. He is retired.

Children

- i Fonda Loy Callen-b m Mr. SIZEMORE
- ii Carnel Lesley Callen-b
- iii Terry Gene Callen-b

3,207-WANDA M CALLEN/ Coy C/ Socrates P/ Hannibal D/ Thomas/
William Callen Sr?

(60G)WANDA MARIE CALLEN was born in Geer Co., Oklahoma on August
15, 1930. On December 11, 1948 in Wellington, Texas she married
CLIFFORD WAYNE YORK. Clifford is in trucking, Wanda is a housewife.

Children

- i Larry Wayne York-b May 17, 1953
- ii Steven Dwayne York-b July 29, 1955
- iii Katrina Gay York-b Oct 24, 1962 m Mr BURNEY

3,208-WILMA D CALLEN/ Coy C/ Socrates P/ Hannibal D/ Thomas/
William Callen Sr?

(60G)WILMA DEAN CALLEN was born January 20, 1939 in Oklahoma. She
is a twin to Norma Jean. Wilma is the owner of a dress shop. She
married RANDALL DEVANE STEWART on June 29, 1957 in Erick, Oklahoma.
Randall was born April 20, 1937 in Sweetwater, Oklahoma, he is an
agent for the Burlington railroad.

Children

- i Valerie Callen-b July 8, 1963 m Mr PACK
- ii Randy Stewart-b February 9, 1965
- iii Rickey Stewart-b June 29, 1967

3,209-NORMA J CALLEN/ Coy C/ Socrates P/ Hannibal D/ Thomas/
William Callen Sr?

(60G)NORMA JEAN CALLEN was born January 20, 1939 in Oklahoma. She
is a twin to Wilma Dean. Norma is a banker by occupation. She
married Mr. WHIPKEY, they are now divorced.

Children

- i Ronald Dean Whipkey-b Jul 12, 1960
- ii Roger Dean Whipkey-b Jan 14, 1968

3,210-NED G CALLEN/ Mack A/ Socrates P/ Americus V/ Thomas/
William Callen Sr?

(60C)NED GIVEN CALLEN was born in rural Mountain Park, Oklahoma on
February 26, 1936. On November 27, 1964 in Lawton, Oklahoma he
married BETTY DELORIS BLANKINSHIP. Betty was born in Frederick,
Oklahoma on December 18, 1944.

Ned is a farmer, as were his father, grandfather, and g-grandfather. "We are farmers here farming wheat, cotton and raise cattle... I live on the land my grandfather S.P. Callen homesteaded in Okla. when he came up from Young Co, Tex."

Children

- i Elana Delores Callen-b Jan 5, 1971
- ii Thesha Diane Callen-b Oct 23, 1974

3,211-CARL V CALLEN/ Roscoe J/ Buenos A/ Augustus G/ Thomas/ William Callen Sr?

(60E)CARL VINCENT CALLEN was born in Reeds Sprints, Missouri on January 2, 1906. He married MABEL CLARA MULLINS on November 12, 1925 in Jerome, Idaho. Mabel was born May 22, 1907 in Sunnyside, Washington. Mabel died October 1975, Carl died October 1983; they are both buried in San Marcos, California.

Children

(all born in Jerome, Idaho)

- i Robert Vincent Callen-b Oct 23, 1926
- ii Carla Mae Callen-b Aug 8, 1928
- iii Daniel Lee Callen-b Dec 3, 1930
- 3,307 iv Wilbur Deane Callen-b Sep 16, 1933
- v Dale Emerson Callen-b May 22, 1936

3,212-JERRY R CALLEN, SR/ Thomas/ Buenos A/ Augustus G/ Thomas/ William Callen Sr?

(60D)JERRY RAY CALLEN, SR was born in Wendell, Idaho on February 27, 1932. He married PATRICIA LEE BOYD on December 30, 1951. Pat was born April 10, 1932 in Jerome, Idaho. Jerry is a farmer - cattle feeder, and has served as State Representative from Idaho.

In 1987 Jerry and Pat had a Callen family reunion on their farm, they report that the second year the reunion was an even greater success, with many new Callen descendants attending.

Children

- 3,308 i Jerry Ray Callen, Jr-b Nov 18, 1953
- 3,309 ii Sandra Louise Callen-b Jan 11, 1955
- 3,310 iii Timothy James Callen-b Mar 11, 1957
- 3,311 iv Gregory Thomas Callen-b Oct 3, 1958
- 3,312 v Melonie Ann Callen-b Sept 20, 1960

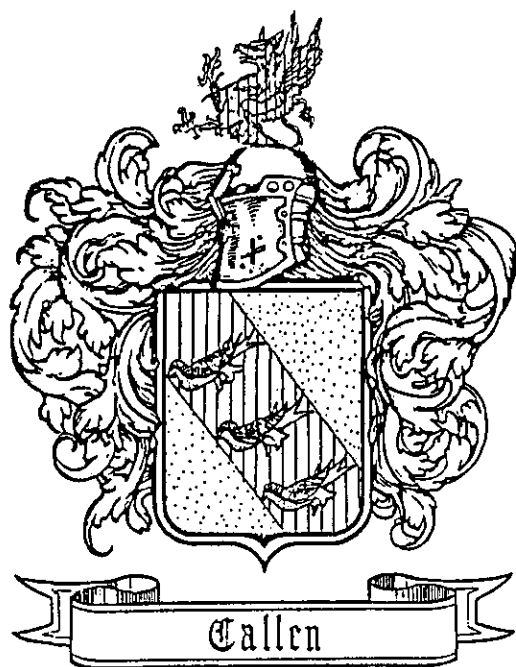

LINE OF WILLIAM CALLEN SR - 7TH GENERATION

3,213-DAVIDSON K KIRKPATRICK/ Samuel A/ John T/ Samuel A/
Elizabeth Callen/ John/ William Callen Sr

(49)"DAVIDSON KERR KIRKPATRICK, only son of Samuel and Sarah
(Cranford) Kirkpatrick, was born September 25, 1901. He married
SUSIE MARGARET CRONE on November 7, 1922.." Susie was born June 12,
1896. Davidson died in 1948, Susie is living in Vienna, Va. (1976)

Children

- i Margaret Cranford Kirkpatrick-b Apr 20, 1925
m HARRY H WETZEL 4 children
- ii Susan Caroline Kirkpatrick-b Sept 20, 1927
m WALTER HARRISON ROGERS 2 daughters
- iii "Pete" David Malcolm Kirkpatrick-b Oct 1, 1940
m ENA LEE TAYLOR 3 children

3,214-ELLA M KIRKPATRICK/ Rollie C/ John T/ Samuel A/ Elizabeth
Callen/ John/ William Callen Sr

(49)"ELLA MAUDE KIRKPATRICK, oldest child of Rollie and Jane
(Pierce) Kirkpatrick, was born February 4, 1912. She married JACK C
SKEELES.. They are living in Alexandria, La." (50A)Ella received a
B.A. from Northwestern La. State U and is a retired teacher.

Children

- i James William Skeeles-b 1940
- ii John Kirkpatrick Skeeles-b 1945
m LYNN VAN WYNGADEN in 1967 John holds DVM, MS &
PhD degrees & is a veterinarian & college professor 4 children

3,215-RALEIGH C KIRKPATRICK/ Rollie C/ John T/ Samuel A/ Elizabeth
Callen/ John/ William Callen Sr

(49)RALEIGH CRITTENDEN KIRKPATRICK, second child of Rollie and
Jane (Pierce) Kirkpatrick, was born March 23, 1914. He married
NANNIE LEE GUY PEAKE..." (50A)He was a graduate of the U.S. Naval
Academy and was a naval aviator in WWII. He retired with the rank
of captain. Raleigh died on June 23, 1984.

Children

- i Jane Peake Kirkpatrick-b 1940
married/divorced JOHN D WALL 2 children
- ii Carolyn Darden Kirkpatrick-b 1944
m WILLIAM REESE SMITH 2 children
- iii Nan Pierce Kirkpatrick-b 1948 m GREGORY S LUKMIRE

3,216-CAROLINE J KIRKPATRICK/ Rollie C/ John T/ Samuel A/
Elizabeth Callen/ John/ William Callen Sr

(49)"CAROLINE JANE KIRKPATRICK, third child of Rollie and Jane
(Pierce) Kirkpatrick, was born July 13, 1917. She married ROBERT
BERTRAM.. They are now divorced." (50A) Caroline retired in 1982
as an accountant with Panola Jr. College.

Children

- i Robert Patrick Bertram-b 1941
- ii Rodney Harris Bertram-b 1946

3,217-RODNEY H KIRKPATRICK/ Rollie C/ John T/ Samuel A/ Elizabeth Callen/ John/ William Callen Sr

(49)"RODNEY HAROLD KIRKPATRICK, youngest child of Rollie and Jane (Pierce) Kirkpatrick, was born February 4, 1919... and has done some family genealogy also." (50A)Rodney died March 16, 1984 and is buried in Fellowship Cemetery, Hineston, La.

3,218-VIRGIE L EVERSULL/ Jewell E Kirkpatrick/ John T/ Samuel A/ Elizabeth Callen/ John/ William Callen Sr

(50G)VIRGINIA "VIRGIE"LEE EVERSULL was born July 23, 1910 in Boyce, Louisiana, daughter of Barnie H and Jewel E Eversull. She married EMMETT DAVIS JARRETT on December 25, 1936 (Christmas day), in Montgomery, La. (50A)Virgie received B.A. and M.A. degrees in elementary education. She retired from teaching in 1975.

Children

- i Emmett Davis Jarrett, Jr-b Feb 21, 1939
 - m I CAROL BAUM II ANNE PRAY SCHEIBNER
- ii Beverly Jane Jarrett-b Oct 27, 1940
 - m QILLIM MILLS IN 1979 1 child

3,219-BEVERLY H EVERSULL/ Jewell E Kirkpatrick/ John T/ Samuel A/ Elizabeth Callen/ John/ William Callen Sr

(50G)BEVERLY HAYDEN(HADEN) EVERSULL, son of Barnie H and Jewel E Eversull was born September 21, 1911 in Boyce, La. He married 1st LUCILLE HARRIS on August 31, 1941, in Jackson, Miss, they divorced in 1949. Beverly married 2nd to BESSIE KATHLEEN BUCKNER on December 18, 1950, in Orange, Tx. He is a member of the Scottish Rite and York Rite Bodies. He retired in 1974 as a construction inspector.

Child of Lucille

- 3,313 i Elizabeth Ann Eversull-b Sept 24, 1942

3,220-JOHN S BROWN/ Mary A Tinsley/ Frances A Kirkpatrick/ Samuel A/ Elizabeth Callen/ John/ William Callen Sr

(50F)JOHN SAMUEL BROWN was born March 30, 1892/94 in Vernon Parish, La. He was the son of "Molly" (Tinsley) and H Thornton Brown. On Dec 23, 1914 he married MARY S FUNDERBURK who was born Oct 1, 1894, daughter of Calla Donia (George) and M.L. Funderburk.

John died December 27, 1930 and is buried in Ebenezer Cemetery, Hicks, La; Mary died December 27, 1967 and is buried in Natchitoches, La.

Only Child

- 3,314 i Ruby Mae Brown-b Sept 9, 1917

3,221-PATRICK H BROWN/ Mary A Tinsley/ Frances A Kirkpatrick/
Samuel A/ Elizabeth Callen/ John/ William Callen Sr

(50F)PATRICK H BROWN was born February 18, 1896 in Vernon Parish, Louisiana. He was unmarried. He served in WWI and WWII. He was a Master Sargent, Stat Recon Squade Air Force. He was stationed in Korea. He died December 25, 1955 in Little Rock, Arkansas.

3,222-SARAH F BROWN/ Mary A Tinsley/ Frances A Kirkpatrick/
Samuel A/ Elizabeth Callen/ John/ William Callen Sr

(50A)SARAH "SALLY" FRANCES BROWN was born February 8, 1898 in Simpson, Vernon Parish, Louisiana. She was the daughter of "Molly" (Tinsley) and H Thornton Brown. Sally was married twice, first to FLOYD BENNETT, and second to ALLEN W JACKSON.

Children

- 3,315 i Ruby Lee Bennett-b 1924
 ii Kenneth Bennett-
 iii R.V. "Andy" Bennett-

3,223-WILLIAM T BROWN/ Mary A Tinsley/ Frances A Kirkpatrick/
Samuel A/ Elizabeth Callen/ John/ William Callen Sr

(50A)WILLIAM THORNTON BROWN was born February 1899, the son of H Thornton and "Molly" (Tinsley) Brown. He married LILLIE MONK.

Children

- i Dalton Brown-
ii Josinell Brown- m HERMAN GILES d 1971
iii William Thornton Brown, Jr-
iv Melba Brown- m LUKE NEVILLE

3,224-JOE WILLIAMSON/ E Viola Tinsley/ Frances A Kirkpatrick/
Samuel A/ Elizabeth Callen/ John/ William Callen Sr

(49)"JOE WILLIAMSON, son of Daniel R Williamson and E Viola Tinsley, was born in 1898. He married BERTHA (last name unknown) and three children were born. Joe was a pipefitter in the shipyards before he retired. He died September 21, 1977 and is buried in Sand Hill Cemetery, Woodville, Texas."

Children

- i Sam Williamson-
ii Glenn Williamson-
iii Laura Williamson- m Mr. THOMPSON

3,225-GEORGE L WILLIAMSON/ Sarah C Tinsley/ Frances Kirkpatrick/
Samuel A/ Elizabeth Callen/ John/ William Callen Sr

(50A-49)GEORGE LEMUEL WILLIAMSON, was born August 11, 1895 in Vernon Parish, La, "son of Elijah and Sallie (Tinsley) Williamson, married C BELLE BENNETT, daughter of Armstrong and Martha Ellen (Jackson) Bennett... on May 20, 1914 in Vernon Parish ..." George died August 8, 1971.

Children

- 3,316 i Douglas Leroy Williamson-b Feb 22, 1916
3,317 ii Luther George Williamson-b Apr 28, 1920

3,226-RUFUS S WILLIAMSON/ Sarah C Tinsley/ Frances Kirkpatrick/
Samuel A/ Elizabeth Callen/ John/ William Callen Sr



RUFUS S WILLIAMSON

(50A)RUFUS SAMUEL WILLIAMSON was born on July 14, 1897 in Vernon Parish, Louisiana. He was the son of Elijah and Sallie (Tinsley) Williamson. On October 9, 1920 in Leesville, Vernon Parish he married ADA BLANCHE DENNIS, daughter of William David & Lillie V (Arnold) Dennis. Blanche was born February 16, 1900 in Falls Co, Texas.

"Rufus attended Louisiana State Normal in Natchitoches, La, (now Northwestern State University) prior to service in WWI and is listed as a teacher on his discharge papers."

(50A)"Mr. Williamson left college in 1917 to enter World War I. He served 27 months, half of the time being served overseas. He was promoted to 2nd Lieutenant in France and after his discharge he joined the Army Reserve. He attended the Paris Conference in 1919 to form a veterans organization where the American Legion was formed and has been a member ever since. When WWII was declared he

was recalled to active duty in 1941 and attained the rank of Major in 1942. He served in Africa & Italy as a commander of a battalion of infantry. After being wounded he was transferred to the 15th Air Force as Provost Marshall. He received the Victory Metal with three stars in WWI, the Purple Heart, Legion of Merit and Victory Metal with three stars in WWII. He was discharged from active duty in 1946 with the rank of Lt. Col.

(50A)"He came to Port Arthur in June 1920, and worked for Texaco, Inc for 42 years, until he retired in August 1962 as Superintendent of the Package Division.

"He was a member of the United Methodist Temple, the Men's Bible Class, Masonic Cosmopolitan Lodge #872 and 1264 A.F.A.M., El Mina Shrine Temple, Eastern Star and Reserve Officers."

(50A-49)Blanche died on March 14, 1968. Rufus married second, WINNIE STEWART on May 9, 1970. Winnie died June 2, 1979. Rufus died on February 18, 1983. He and Blanche are buried in Greenlawn Cemetery, in Port Arthur, Texas.

Children

- 3,318 i Doris Kathryn Williamson-b Nov 11, 1921
3,319 ii Rufus Samuel "Bubba" Williamson, Jr-b Nov 27, 1923
3,320 iii Lillie Francis Williamson-b Oct 26, 1928

3,227-EUGENE L WILLIAMSON/ Sarah C Tinsley/ Frances Kirkpatrick/
Samuel A/ Elizabeth Callen/ John/ William Callen Sr
(50A)EUGENE LARKIN WILLIAMSON was born on June 4, 1899 in Vernon
Parish, Louisiana. He married THELMA HICKS (49)daughter of Joseph
and Martha (Bennett) Hicks. Eugene died on April 25, 1970.

Children

- 3,321 i Leroy Williamson-b Sept 17, 1924
3,322 ii Ronald Loy Williamson-

3,228-FRANCES E WILLIAMSON/ Sarah C Tinsley/ Frances A
Kirkpatrick/ Samuel A/ Elizabeth Callen/ John/ William Callen Sr
(49)"FRANCES EFFIE WILLIAMSON [called Effie], daughter of Elijah
and Sallie (Tinsley) Williamson, was born January 14, 1900 in
Louisiana." She was the second wife of JESSIE EDGAR JACKSON, they
were married (50A)on January 1, 1917. "Edgar" was the son of James
Wesley and Alice Jackson, and was born March 19, 1892. Effie died
November 13, 1926, she is buried in Pine Island Cemetery, Simpson,
Louisiana.

Children

- 3,323 i Charlotte Blanche Jackson-b July 31, 1918
ii Raymond Clinton Jackson-b Apr 29, 1920
m MARGURETE GRANGER
iii Lorene Jackson-b Oct 28, 1921 m RAYBURN HULL

3,229-CHARLEY E WILLIAMSON/ Sarah C Tinsley/ Frances Kirkpatrick/
Samuel A/ Elizabeth Callen/ John/ William Callen Sr
(49)"CHARLEY EDGAR WILLIAMSON, son of Elijah and Sallie (Tinsley)
Williamson, was born March 3, 1905. He married LENA COOK" on April
26, 1929, she "died August 3, 1968. Charley married 2nd LETA
HAWTHORNE SMITH on February 21, 1970..." (50A)Charley died April
17, 1988 and is buried in Greenlawn Memorial Park, Port Arthur, Tx.

Children of Lena

- 3,324 i Sallie Charlene Williamson-b Aug 7, 1931
3,325 ii Robert Leon Williamson-b May 4, 1935
3,326 iii Edgar Harold Williamson-b October 21, 1941

3,230-BERTHA N WILLIAMSON/ Sarah C Tinsley/ Frances Kirkpatrick/
Samuel A/ Elizabeth Callen/ John/ William Callen Sr
(50A-49)BERTHA NAOMI WILLIAMSON, "daughter of Elijah Williamson
and Sallie (Tinsley), was born March 1, 1907. She married JAMES
FRANKLIN ANTILLEY on December 22, 1928. James died Nov 22, 1959.
Bertha is living in a nursing home in Port Arthur, Tx and is a

retired nurse (1977)."

Children

3,327 i Bobbie Faye Antilley-b Sept 6, 1929
3,328 ii Rudolph Antilley-b Aug 26, 1934
3,329 iii Aubrey Allen Antilley-b July 10, 1936

3,231-EULA D WILLIAMSON/ Sarah C Tinsley/ Frances Kirkpatrick/
Samuel A/ Elizabeth Callen/ John/ William Callen Sr
(50A-49)EULA D WILLIAMSON was born on January 4, 1909, the
daughter of Elijah and Sallie (Tinsley) Williamson. She married
first NAPOLEON B MAYO on May 8 1926. "They were later divorced and
she married second, MILTON S CRAWFORD on May 8, 1929." Eula died
August 22, 1970. She is buried in Houston, Texas. She had no
children.

3,232-LEON B WILLIAMSON/ Sarah C Tinsley/ Frances Kirkpatrick/
Samuel A/ Elizabeth Callen/ John/ William Callen Sr
(50A-49)LEON BORDEN WILLIAMSON, "son of Elijah Williamson and
Sallie Tinsley, was born February 10, 1912. He married BESSIE SMITH
on January 12, 1935... Leon Williamson married second, BUNA CHAPMAN
on August 26, 1960." Leon died May 28, 1965.

Children of Bessie

i Louis Borden Williamson
ii Clyde Edgar Williamson-

3,233-VONNIE V KIRKPATRICK/ Solomon E/ Augustus C/ Samuel A/
Elizabeth Callen/ John/ William Callen Sr
(50A)VONNIE V KIRKPATRICK was born July 26, 1914 in Melder,
Rapides Co, Louisiana. She is the daughter of Solomon E and Carrie
(Ashmore) Kirkpatrick. On June 9, 1938 she married HICKMAN O
JOHNSON.

3,234-GLADYS L KIRKPATRICK/ Solomon E/ Augustus C/ Samuel A/
Elizabeth Callen/ John/ William Callen Sr
(50A)GLADYS LUCILLE KIRKPATRICK was born April 1, 1919 in Melder,
Rapides Co, Louisiana. On December 28, 1945 she married JOHN KELLY
McRANEY. Gladys died February 7, 1978.

3,235-JOHN T KIRKPATRICK/ Solomon E/ Augustus C/ Samuel A/
Elizabeth Callen/ John/ William Callen Sr
(50A)JOHN TUCK KIRKPATRICK was born April 30, 1921 in Melder,
Rapids Co, Louisiana. He is the son of Solomon E and Carrie
(Ashmore) Kirkpatrick. On March 21, 1947 he married CORRINE
BROWNING. He married again in April 1976 to RUBY TAYLOR PECK.

3,236-JUANITA KIRKPATRICK/ Solomon E/ Augustus C/ Samuel A/
Elizabeth Callen/ John/ William Callen Sr
(50A)JUANITA KIRKPATRICK was born December 13, 1922 in Melder,
Rapides Co, La. On March 17, 1946 she married ALVIN D JELKEN.

3,237-SOLOMON E KIRKPATRICK/ Solomon E/ Augustus C/ Samuel A/
Elizabeth Callen/ John/ William Callen Sr
(50A)SOLOMON EDGAR KIRKPATRICK, JR. was born on March 2, 1926 the
son of Solomon E and Carrie (Ashmore) Kirkpatrick. On February 14,
1953 he married LOUISE BRIDENALL. He married 2nd on September 24,
1955 to GWENDOLYN DAVIDSON who was born on February 15, 1923 in
Woodworth, Louisiana. Gwendolyn is the daughter of John Wesley and
Grace (Moore) Davidson. They are living in Port Neches, Texas.

Child

1 David Edgar Kirkpatrick-b Jan 26, 1957

3,238-PATTIE R KIRKPATRICK/ Solomon E/ Augustus C/ Samuel A/
Elizabeth Callen/ John/ William Callen Sr
(50A)PATTIE RUTH KIRKPATRICK was born January 7, 1931 in Glenmora,
Rapides Co, La. On October 24, 1952 she married EDWARD MARION MONK.

Child (May be partial list)

1 Charles Randall Monk-b Feb 5, 1962 Alexandria LA

3,239-TAYLOR GUICE, JR/ Bessie R Pickens/ Samuel R/ Nancy H
Callen/ Ross/ John/ William Callen Sr
(50E)TAYLOR GUICE, JR was the only son of Bessie R (Pickens) and
Taylor Guice. He married RUTH REICHEL. Taylor died in WWII.

Only Child

1 Judith Guice-

3,240-RENA L GLASS/ John L/ Ross C/ Margaret F Callen/ Ross/ John/
William Callen Sr
(50E)RENA LEIGH GLASS was born December 3, 1894, the oldest child
of John l and Effie (Golson) Callen. Married AUBREY ROBINSON.

Only Child

1 Aubrey Glass Robinson-b Sept 12, 1923

3,241-BETTY S GLASS/ Sturgeon F/ Ross C/ Margaret F Callen/ Ross/
John/ William Callen Sr
(50E)BETTY SUE GLASS was born May 9, 1922, the daughter of
Sturgeon F and Julia (Bell) Glass. She married GEORGE C CRANE.

Only Child

1 Julia Crane-

3,242-JAMES M GLASS/ James F/ Ross C/ Margaret F Callen/ Ross/
John/ William Callen Sr

(50E)JAMES MALCOLM GLASS was born November 7, 1902, the oldest son
of James F and Loyd (Wood) Glass. He married GLADYS (unknown).

Children

- i Jeannine Glass-
- ii Jimmie Glass-
- iii Sarah Glass-

3,243-EUGENIA E GLASS/ James F/ Ross C/ Margaret F Callen/ Ross/
John/ William Callen Sr

(50E)EUGENIA ELLEN GLASS was born August 7, 1905, the daughter of
James F and Loyd (Wood) Glass. She married JOHN R THOMAS.

Children

- i Rebecca Ellen Thomas-
- ii John R Thomas, Jr-

3,244-ROBERT M GLASS/ Joseph R/ Ross C/ Margaret F Callen/ Ross/
John/ William Callen Sr

(50E)ROBERT MALCOLM GLASS was born October 12, 1921, the son of
Joseph R and Claude (Grant) Glass. He married EDNA EARL LAMBERT.

Only Child

- i Joseph Glass-

3,245-MALCOLM H PRESLEY/ Rebecca A Glass/ Ross C/ Margaret F
Callen/ Ross/ John/ William Callen Sr

(50E)MALCOLM HOLMS PRESLEY was born January 3, 1909, the son of
Rebecca A (Glass) and Percy H Presley. He married DAINA ADAMS.

Only Child

- i Daina Patricia Presley-

3,246-GERTRUDE R PRESLEY/ Rebecca A Glass/ Ross C/ Margaret F
Callen/ Ross/ John/ William Callen Sr

(50E)GERTRUDE REBECCA PRESLEY was born January 6, 1911, the
daughter of Rebecca A (Glass) and Percy H Presley. She married
MICHAEL L MASCIA on April 9, 1940.

Children

- i Pamela Mascia-b Dec 31, 1941
- ii Trudy Belle Mascia-b May 3, 1944

3,247-ELAINE GLASS/ Folsom L/ Ross C/ Margaret F Callen/ Ross/
John/ William Callen Sr

(50E)ELAINE GLASS was born November 27, 1921, the daughter of
Folsom L and Lillie (Kern) Glass. She married EWELL CLARK.

Only Child

i Ann Penton Clark-b Dec 29, 1949

3,248-FLORETTA GLASS/ Folsom L/ Ross C/ Margaret F Callen/ Ross/
John/ William Callen Sr

(50E)FLORETTA GLASS was born November 24, 1926 the daughter of
Folsom L and Lillie (Kern) Glass. She married NEIL CLARK.

Children (both married with 1 child)

i Melissa Bryan Clark-b Feb 19, 1954

ii Neil Penton Clark-b Mar 20, 1955

3,249-CLIFFORD M COOK/ Eva E Glass/ Ross C/ Margaret F Callen/
Ross/ John/ William Callen Sr

(50E)CLIFFORD MARGUERITE COOK was born August 10, 1919, the
daughter of Eva E (Glass) and Clifford C Cook. She married JULIUS
H SPANN.

Only Child

i Leighton Spann- Feb 9, 1952

3,250-BIRDIE L GLASS/ Clarence/ William J F/ Margaret F Callen/
Ross/ John/ William Callen Sr

(50D)BIRDIE LORAIN GLASS was born January 14, 1914, the daughter
of Clarence and Ray (Etter) Glass. On May 30, 1942 she married W.C.
"BLACKIE" NICKLAS. Blackie was born February 12, 1913. Blackie
died in April 1983, "Bird L" died September 10, 1985; both are
buried in Lone Oak, Texas.

3,251-DOROTHY D GLASS/ Charles R/ William J F/ Margaret F Callen/
Ross/ John/ William Callen Sr

(50D)DOROTHY DALE GLASS was born November 26, 1914 in Emory,
Texas. On July 18, 1948 in Conroe, Texas she married FRED DAVIS
RALPH who was born June 15, 1911. Dorothy died February 20, 1978.

3,252-MARY A GLASS/ Charles R/ William J F/ Margaret F Callen/
Ross/ John/ William Callen Sr

(50D)MARY ALICE GLASS was born December 3, 1920 in Emory, Texas.
On March 24, 1941 she married JAMES PINKNEY JOHNSON, who was born
April 5, 1919 and died August 23, 1978.

Children

3,330 i James David Johnson-b Aug 31, 1944

3,331 ii Martha Lynn Johnson-b Jan 29, 1948

3,253-CHARLES N GLASS/ Charles R/ William J F/ Margaret F Callen/
Ross/ John/ William Callen Sr

(50D)CHARLES NORWOOD GLASS was born February 13, 1923. On August 3, 1946 he married RUBY MARGARET HOLLINGSWORTH who was born February 7, 1927. Ruby died April 26, 1985. On October 26, 1985 Charles married ELLEN VIRGINIA BROWN who was born March 17, 1933.

Children of Ruby

3,332 i Carol Margaret Glass-b Jul 21, 1949
3,333 ii Zyle Rush Glass-b Oct 14, 1951
3,334 iii Linda Ann Glass-b Jun 9, 1956
3,335 iv Nancy Ellen Glass-b Sept 23, 1957
3,336 v Rue Ann Glass-b Jan 16, 1959

3,254-LINDA L GLASS/ Charles R/ William J F/ Margaret F Callen/
Ross/ John/ William Callen Sr

(50D)LINDA LOU GLASS was born March 8, 1930. She married CAMPBELL VICTUA WOODMAN who was born September 23, 1929. Campbell died July 15, 1978.

3,255-MARY J NICELY/ Mattie L Glass/ William J F/ Margaret F
Callen/ Ross/ John/ William Callen Sr

(50D)MARY JANE NICELY was born July 27, 1917. On August 27, 1946 she married DAVID RANDOLPH "BOB" SALMON who was born September 2, 1910. Bob died November 25, 1982.

3,256-BILLIE B CHAMBERS/ Velma S Glass/ William J F/ Margaret F
Callen/ Ross/ John/ William Callen Sr

(50D)BILLIE BOB CHAMBERS was born April 14, 1917 in Emory, Texas. On December 28, 1940 he married DAISY DEAN ANTHONY who was born November 25, 192___. Billie died December 7, 1968 and Daisy remarried, living in Houston in 1986.

Children

3,337 i Charles Michael Chambers-b Dec 9, 1943
3,338 ii Brian Allen "Pat" Chambers-b Feb 7, 1946
3,339 iii Gary Gene Chambers-b Apr 27, 1953
3,340 iv Molly Ann Chambers-b May 27, 1956

3,257-JOE C CHAMBERS/ Velma S Glass/ William J F/ Margaret F
Callen/ Ross/ John/ William Callen Sr

(50D)JOE CHARLES CHAMBERS was born January 30, 1922. On May 2, 1943 he married NELLIE MAE BALLARD who was born February 6, 1924.

Children

3,341 i Barbara Gay Chambers-b Feb 5, 1944
3,342 ii Dianne Elizabeth Chambers-b Dec 29, 1946
3,343 iii Mark Chambers-b Jul 23, 1953

3,258-REBECCA C GLASS/ Wicker I/ William J F/ Margaret F Callen/
Ross/ John/ William Callen Sr

(50D)REBECCA CAROLYN GLASS was born February 6, 1921. On December 20, 1945 she married WILLIAM MICHAEL WARREN who was born July 5, 1917. Carolyn has helped with the information and research in this book.

Children

	3,344	i	William Michael Warren, Jr-b Jun 8, 1947
	3,345	ii	Charles Wicker Warren-b Nov 9, 1948
	3,346	iii	John Wells Warren-b Oct 4, 1952
twin	3,347	iv	James Perrin Warren-b Jul 2, 1954
twin	3,348	v	Joseph Robert Warren-b Jul 2, 1954
	3,349	vi	Andrew Louis Warren-b Jan 2, 1961

3,259-JOE L GLASS/ Wicker I/ William J F/ Margaret F Callen/ Ross/
John/ William Callen Sr

(50D)JOE LOUIS GLASS was born August 10, 1928 in Conroe, Texas. On May 27, 1952 he married JONELL SEALE who was born August 30, 1931.

Children

	3,350	i	Rebecca Jane Glass-b Dec 23, 1953
	3,351	ii	Cynthia Lynn Glass-b Dec 20, 1954
	3,352	iii	Joe Louis Glass, Jr-b Mar 22, 1958

3,260-TOMMIE E GLASS/ William R/ William J F/ Margaret F Callen/
Ross/ John/ William Callen Sr

(50D)TOMMIE EARL GLASS - also called CLARENCE ALEXANDER although his birth certificate shows his name to be Tommie Earl. Tommie was born July 20, 1920. He was killed in action in WWII April 9, 1944, and is buried in Leige, Belgium.

3,261-HARRIETT S WOODSON/ Irene E Glass/ William J F/ Margaret F
Callen/ Ross/ John/ William Callen Sr

(50D)HARRIETT SUE WOODSON was born January 28, 1921. On December 20, 1941 she married KELTON BENTON FULTZ, they were divorced in 1947. Sue died October 25, 1985.

Only Child

i	Sue Carol Fultz-b Jul 15, 1946	Conroe Tx
m	JACK PROOS	on Dec 5, 1980

3,262-JAMES M GILMER JR/ James M Sr/ Ada Callen/ Hamilton H/ John
K/ John/ William Callen Sr

(50C)JAMES M GILMER JR was born September 21, 1927, the son of James M and Marie Gilmer. He lived in Tennessee. James was interested in his family history, and has contributed much to this book. He married BEVERLY (Unknown). Jim died on December 26, 1988 of a heart attack.

3,263-JOSEPH B KNIGHT/ Claude K/ Malena Kirkpatrick/ William L/
Nancy Callen/ John/ William Callen Sr

(50A-50H)JOSEPH STURDEVANT KNIGHT was born August 29, 1932 in Selma, Alabama, he is the son of Claude K and Clara Ida (Williams) Knight. On May 5, 1973 he married his second wife FLORENCE ANNE FALKENBERRY who was born June 23, 1948 the daughter of Roswell L and Eleanor F (Rennie) Falkenberry.

Joseph is an Economic Development Consultant and Episcopal Priest, Anne is a librarian. They are presently living in Birmingham, Al.

Children of 1st wife

- 3,353 i Kay Angela Knight-b Jul 26, 1955
- 3,354 ii Vicki Elizabeth Knight-b Aug 31, 1957
- Child of Anne
- iii Joseph Kirkpatrick Knight-b Apr 26, 1975

3,264-HARRIETT M GRIZZLE/ Georgia M Mills/ Dorcus M Hooks/ Julius A/ Dorcas Callen/ John?/ William Callen Sr

(50B)HARRIET MALINDA "LINDA" GRIZZLE was born January 10, 1941 in Lake Creek, Delta Co, Texas. On August 30, 1958 in Corsicana, Texas she married BILLY BUFORD BARNES who was born July 26, 1935 in Corsicana, Texas. Billy has an ancestor named "Thomas Callins", whom we believe might have been Thomas Callen(Callins) son of John Callen.

Linda is a teacher's aide and teaches in a school for retarded children, she also enjoys family research as a hobby and has contributed to the research and information in this book.

Children

- i Craig Alan Barnes-b Mar 25, 1968
- ii Malinda Kay Barnes-b Dec 15, 1969

3,265-ETHEL C MURPHREE/ Willie C Purcell/ Mary E Callen/ Thomas A/ William III/ James/ William Callen Sr

(55A)ETHEL CLAIRE MURPHREE was born December 6, 1902. (51)"She attended Ward-Belmont College, Nashville, Tenn. She is an accomplished pianist." (53A)On June 9, 1927 she married JOSEPH FRANKLIN WALTERS who was born in 1902, (51)he is a pavement contractor. (53b)Joe died in 1984.

Children

- 3,355 i Joseph Franklin Walters Jr-b Jan 18, 1929
- 3,356 ii Mary Gene Walters-b Mar 3, 1931

3,266-RUTH P MURPHREE/ Willie C Purcell/ Mary E Callen/ Thomas A/ William III/ James/ William Callen Sr

(55A)RUTH PURCELL MURPHREE was born July 21, 1905. (53)"She graduated with honors from Randolph-Macon Woman's College at Lynchburg, Va. In her senior year she was editor-in-chief of the

college annual and chairman of the May Day festivities. She has twice won first prize in the Alabama Federation of Music Clubs for the best original piano composition."

(55A)On June 16, 1928 she married EVANS SMITH DORSEY who was born in 1906. Evans died in 1965, Ruth died in 1974. They had no children.

3,267-ALLIE C MURPHREE/ Willie C Purcell/ Mary E Callen/ Thomas A/ William III/ James/ William Callen Sr

(55A)ALLIE CARROLL MURPHREE was born December 31, 1907. (53)"She was named for her aunt, Mrs Allie Carroll, a beloved benefactress of the Baptist church in Alabama. Allie Carroll Murphree attended Mills Kindergarten, New York, City, and the Woman's College (Huntingdon College) of Alabama. She is a violinist and has marked talent for aesthetic and interpretative dancing."

(55A)On November 7, 1937 she married ROBERT HAMILTON JONES who was born in 1912. Robert died in 1965. Allie married 2nd in 1968 to SID JACKSON who was born in 1901.

3,268-MILDRED C ABERNATHY/ Selma Purcell/ Mary E Callen/ Thomas A/ William III/ James/ William Callen Sr

(55A)MILDRED CALLEN ABERNATHY was born September 21, 1898. (53)"She graduated at Randolph-Macon Woman's College, Lynchburg, Va, with Phi Beta Kappa honors. She also studied at Harvard University. She has taught for a number of years quite successfully at the famous Tubman High School in Augusta, Ga."

(55B)On August 10, 1925 she married MONTGOMERY RHIND RIDGELY who was born in 1879. Montgomery died in 1969, Mildred died in 1983. They had no children.

3,269-JOHN D ABERNATHY/ Selma Purcell/ Mary E Callen/ Thomas A/ William III/ Jame/ William Callen Sr

(55A)JOHN DANIEL ABERNATHY, JR. was born October 24, 1904. (53)"He attended the University of Georgia..." (55A)On December 11, 1935 he married ELSIE KATHERINE SANDER who was born in 1911. John died in 1968.

Children

	3,357	i	John Daniel Abernathy III-b	May 2, 1937
twin	3,358	ii	Eugene Sander Abernathy-b	July 2, 1940
twin		iii	Thomas Purcell Abernathy-b	July 2, 1940
			m LAURA LEE FARIS	divorced 1974

3,270-JOHN F COLLINS/ Ruby E Purcell/ Mary E Callen/ Thomas A/ William III/ James/ William Callen Sr

(55A)JOHN FLOYD COLLINS, JR. was born July 16, 1897. (53)"He graduated from Emory University, magna cum laude, in 1924. He has marked literary ability. He holds a government position in Washington."

(55A)On March 30, 1935 he married OLYVE COSTNER who was born in 1904. John died in 1961, Olyve died in 1977.

Children

- i John Floyd Collins III-b May 1, 1939
- ii Eleanor Collins-b 1942

3,271-MEREDITH P COLLINS/ Ruby E Purcell/ Mary E Callen/ Thomas A/ William III/ James/ William Callen Sr

(55A)MEREDITH PURCELL COLLINS was born July 30, 1899. (53)"He attended the Southern University, Greensboro, Ala. He saw service overseas with the A.E.F, during the World War. Now he is engaged in the newspaper business at Birmingham, Ala."

(55A)On July 11, 1940 he married ANNIE MAE McWHIRTER who was born in 1903. (55C)Meredith died in 1986.

Only Child

- 3,359 i Averil Collins-b 1942

3,272-MILTON M COLLINS/ Ruby E Purcell/ Mary E Callen/ Thomas A/ William III/ James/ William Callen Sr

(55A)MILTON MASSEY COLLINS was born March 1, 1901. (53)"He graduated with highest honors at Alabama Polytechnic Institute, Auburn, Ala, in June, 1924. He is an electrical engineer."

(55A)On July 7, 1927he married ANASTASIA POWERS who was born in 1903. Anastasia died in 1967. Milton married again in 1970 to MARTHA BAPTIST DessASSURE who was born in 1909. Milton died in 1974.

Children of Anastasia

- 3,360 i Robert Milton Collins-b Sept 20, 1929
- 3,361 ii Patricia Powers Collins-b Oct 19, 1933

3,273-WILLIAM B COLLINS/ Ruby E Purcell/ Mary E Callen/ Thomas A/ William III/ James/ William Callen Sr

(55A)WILLIAM BRUCE COLLINS was born December 28, 1911. (53)"In June, 1935, he graduated from Alabama Polytechnic Institute with highest honors. He is in the employ of the Alabama Power Company at Eufaula, Ala."

(55A)On August 7, 1936 he married MILDRED ELIZABETH CADE. William died in 1948.

Children

- 3,362 i Mildred Elizabeth Collins-b June 29, 1939
- 3,363 ii Sarah Margaret Collins-b 1947

3,274-THELMA B PURCELL/ Thomas M/ Mary E Callen/ Thomas A/ William III/ James/ William Callen Sr

(55A)THELMA BERNICE PURCELL was born May 3, 1912. (53)"In June 1933 she graduated from the University of Georgia." (55A)On June 18, 1935 she married WYCKLIFFE AUSTIN KNOX who was born in 1909. (53)"Mr. Knox is engaged in the building and lumber business and is Mayor of Thomson."

(55B)Wyckliffe died in 1976. Bernice married 2nd in 1981 to DENVER WALLACE SWANSON.

Children

3,364 i Harriett Ethel Knox-b July 3, 1938
3,365 ii Wyckliffe Austin Knox, Jr-b Nov 1, 1940

3,275-THOMAS M PURCELL JR/ Thomas M/ Mary E Callen/ Thomas A/ William III/ James/ William Callen Sr

(55A)THOMAS MALCOLM PURCELL, JR was born May 9, 1915. (53)"He has attended the University of Georgia and taught awhile at Empire, Ga. He has done splendid work and is highly regarded by those who are associated with him. He received his A.B. in Journalism, University of Georgia, 1940, and is now in the Naval Reserves (1941)".

He married JOYCE BISHOP who was born in 1942, they are divorced.

Children

i Thomas Malcolm Purcell III-b 1964
ii Susan Victoria Purcell-b 1965
iii John Callen Purcell-b 1966
iv James Davis Purcell-b 1968
v Rachel Ann Purcell-b 1969
vi Rebecca Myrtle Purcell-b 1973

3,276-WILLIAM W R PURCELL/ Clare/ Mary E Callen/ Thomas A/ William III/ James/ William Callen Sr

(55C)WILLIAM WOOD ROWE "WOODY" PURCELL was born December 19, 1911, the son of Clare and Ida (West) Purcell. He married 1st in 1937 to CAROLINE RANDALL GRAY. Caroline was born in 1916, she died in 1975. "Woody" married again in 1977 to MARTHA ISABELL WILLIS who was born in 1911.

Isabelle wrote a posthumous resume concerning Woody's education, hobbies, and accomplishments - here are a few of her notes:

"Woody held a Bachelor of Science in Electrical Engineering from the University of Alabama. He did his graduate studies in science and mathematics at the University of Alabama in 1934. He also attended the U.S. Army Command and General Staff College, and Armed Forces Staff College. He was a member of the Society of American Military Engineers and retired as Colonel, U.S. Army on July 1, 1966.

"He was a charter member of the Augusta Genealogical Society; member of Augusta Historical Society; Augusta Opera Association; Augusta Symphony; Active in the First Baptist Church, in Augusta;

Past-President of The Retired Officers Association; member of the Gordon Lakes Golf Club; member of the Officers Club, Ft. Gordon. Ga.

"He made a tremendous contribution to Cancer research as a volunteer to the National Cancer Institute in Bethesda, Md. for the "Antibody Monoclonal Procedure", which is still in the "research stage". He was there from Sept 23, 1987 through Oct 3rd. He died October 27, 1987 in St. Mary's Hospital, Augusta, Ga., and is buried in Westover Memorial Park, Augusta, Ga."

Children of Caroline

- 3,366 i Carol Ann Purcell-b Mar 19, 1939
3,367 ii William Wood Rowe Purcell, Jr-b Sept 20, 1942

obituary of WM WOOD ROWE PURCELL
(Augusta Chronicle, October 1987)



"WILLIAM WOOD ROWE "Woody" PURCELL [aged] 75... died October 27, 1987 at St. Joseph's Hospital, Augusta Ga. Funeral services were held at First Baptist Church... Burial was at Westover Memorial Park Cem Augusta, Ga... with full Military Honors. Military Pallbearers.. Firing Squad for twenty-one gun salute.

"Col (retired) PURCELL was born in Madison, Ala the son of Bishop & Mrs Clare Purcell December 19, 1911.

"He served thirty-three years in the United States Army as a Career Officer, Corps of Combat Engineers. He was the first Commanding Officer of the 138th Battalion of Combat Engineers when it was organized at Ft. Jackson, South Carolina in 1941. The Battalion left America with the 4th Division for Europe where he served his country during World War II in England, Germany, France, Denmark and other European Countries, then returned to the Pentagon, serving under the Chief of

COL WM WOOD ROWE PURCELL

Engineers, U.S. Army on two different occasions. He was Liaison Officer to the Canadian Army, an "Occupying Officer" on Okinawa and also in Pusan, Korea. He retired as Post Center Engineer at Fort Gordon, Augusta, Ga. in 1966 where he continued to reside.

"He received the National Defense Service Medal w/OLC [with Oak Leaf Cluster], Armed Forces Reserve Medal, Army Commendation Medal w/OLC, Legion of Merit Award, General Staff certification for service with Canadian Army and Citation for Services from the General Chief of U.S. Army Engineers, Victory Medal; European-African-Middle Eastern Theater Medal with 2 Bronze Stars for Rhineland and Central Europe Campaigns, American Theatre Medal and American Defense Service Medal.

"COL. PURCELL graduated and did post-graduate work at the University of Alabama. He was Pi Kappa Phi, Omicron Delta Kappa and Tau Beta Pi. He was honored for being "most helpful to his fellowman" with the Sullivan Award and graduated with highest honors.

"He attended and was active in First Baptist Church, Augusta, Ga. He was a past-president of the Retired Military Officers Association, Charter member of Augusta Genealogical Society and Augusta Historical Society.

"He is survived by his wife Isabell W Purcell, who resides at their present home, a son W.R. Purcell, Jr., College Station, Tx, a daughter Mrs. T.E. (Carol) Stevens, Hudson, Ohio and a step-daughter Mrs. Van (Gladys Ann) Simpson of Augusta, a brother John Purcell of Trussville, Ala, and a sister Mrs. Alexander (Claire) Purcell of Elkin, N.C. He also leaves eight grandchildren, three great grandchildren and a number of nieces and nephews. He was formerly married to Caroline Gray who preceded him in death."

3,277-JOHN R PURCELL/ Clare/ Mary E Callen/ Thomas A/ William III/ James/ William Callen Sr

(55A)JOHN ROBERT PURCELL was born July 2, 1915. (53)"He attended the Birmingham-Southern College, and is now employed by the Goodyear Rubber Company at Gadsden, Ala."

(55A)On April 20, 1935 he married LOIS ETHEL WAITS who was born in 1912.

Children

	i Ethel Ida Purcell-b Nov 15, 1936
	m in 1963 DONALD BLANTON MORRIS no children
3,368	ii Joan Alice Purcell-b 1941
twin	iii John Robert Purcell, Jr-b 1943 Bachelor
twin	iv Prestley Waits Purcell-b 1943 d 1943
3,369	v Douglas Clare Purcell-b 1946
3,370	vi James Michael Purcell-b 1948

3,278-IDA C PURCELL/ Clare/ Mary E Callen/ Thomas A/ William III/
James/ William Callen Sr

(55A)IDA CLAIRE PURCELL was born December 5, 1921. (53)"In June, 1938, she graduated from the Gadsden High School. Recently (1941?) she was chosed to represent the State of Alabama in the Good Citizen Conference at Washington, D.C. with all expenses paid by the Federated Woman's Clubs of Alabama. She is attending at this time Agness Scott College at Decatur, Ga. For the first semester in her freshman year, she received distinction on everything."

In 1945 she married ALEXANDER MARTIN SMITH II who was born in 1918.

Children

- i Clare Purcell Smith-b 1950
m in 1981 WALTER GIBBS BAUM
- 3,371 ii Ray Harvison Smith-b 1952
- iii Martha Marshall Smith-b 1954

3,279-ALLEN D CULVERHOUSE/ Eugen/ William/ Mary Callen/ William III/ James/ William Callen Sr

(55E)ALLEN D CULVERHOUSE was born on May 10, 1911 in Dallas Co, Selma Alabama. He was the son of Eugen and Alice (Dennard) Culverhouse. On December 23, 1932 he married KATIE ROSALIND BAYNE who was born December 15, 1913 in Selma, Alabama. Allen died on June 10, 1967 in Virginia Beach, Virginia.

Children

- i E.A. Culverhouse-b 1934
- ii Betty Jean Culverhouse-b 1936
- iii William Edward Culverhouse-b 1938
- iv Carolyn Louise Culverhouse-1941

3,280-MURIEL M GEORGE/ Arthur/ William S/ James C/ Elizabeth Callen/ James/ William Callen Sr

(50B-55H)MURIEL MARIE GEORGE was born February 6, 1914 in Sasakwa, Seminole Co, Ok. On April 21, 1933 she married CHESTER LEE SMITH.

Child

- i Jerry L Smith- does family research

3,281-GLADYS E HARRISON/ Mary L George/ Hosia H/ James C/ Elizabeth Callen/ James/ William Callen Sr

(55F)GLADYS ELIZABETH HARRISON was born May 14, 1907 in Oklahoma, the daughter of William H and Mary L (George) Harrison. On December 22, 1923 in Fisher Co, Texas she married FRITZ ALFORD ADAIR, who was born October 15, 1900 in Coosa Co. Alabama. Gladys was a housewife and motel owner. Fritz died October 30, 1972, Gladys died November 2, 1979; both are buried in Portales, Roosevelt Co, New Mexico.

Children

- i Mary Juanita Adair-b Nov 18, 1927 d Jan 19, 1980
3,372 ii Jimmie Onita Adair-b June 27, 1929
iii Gladys Loretta Adair-b Aug 18, 1937 d Feb 8, 1938
iv Fritz Alford Adair Jr-b Dec 13, 1943

3,282-CHARLIE W SLAYTON/ Henry W/ Mary F Williams/ Jamima F
Choate/ Mary Callen/ James/ William Callen Sr

(55D)CHARLIE WINGATE SLAYTON was born on July 5, 1907 in Hughes Springs, Texas. He was the son of Henry W and Susan E (Truitt) Slayton. By occupation he was a carpenter. On July 16, 1931 in Oklahoma he married MARY RUTH FORTENBERRY who was born on October 29, 1907 in Greenwood, Texas. Charlie died on July 31, 1967, Mary died on August 17, 1963; both are buried in Rosston, Texas.

Children

- i Paul L Slayton-b May 10, 1932
3,373 ii Billy W Slayton-b Oct 7, 1935

3,283-ELSIE L PERRY/ Edith L Averyt/ Thomas D/ Francis Martin/ Ann
Callen/ James/ William Callen Sr

(55G)ELSIE LUCILE PERRY was born on May 5, 1923 in Houston, Harris Co, Texas. On December 21, 1945 she married "DAN" DUARD ARNOLD TUCKER. Elsie enjoys family research.

3,284-ALLIE W CALLAN/ Allie W/ George M II/ William D Callen/
George A/ William Jr/ William Callen Sr

(45-51A)ALLIE WILLIS CALLAN JR was born November 24, 1921 in Fort Smith, Arkansas, the son of Allie W and Eunice (Harmon) Callan.

(51B)He graduated from Ft Smith Senior High School where he lettered in track. He graduated from Arkansas Tech in 1940 where he majored in Engineering, and also lettered in track and boxing. He earned a Private Pilot Certificate in Civilian Pilot Training Program.

"On February 16, 1946 he married EMILY SUE HENDRICKS who was born July 13, 1925 in Fort Smith, Arkansas. Emily is a member of the First Baptist Church and sings in the choir. She was a member of the Glee Club in both Junior and Senior High School. She became a telephone operator in 1943 and later promoted to Observer and Supervisor.

"In April of 1942 he joined the U.S. Navy as a Naval Aviation Cadet. He was Commissioned as Ensign USNR and earned Navy wings in December of 1942. "Captain Callan served as a Navy test pilot in the Flight Test Division at the Naval Air Test Center, Patuxent River, Maryland and was one of the early pioneer jet pilots. Later served in 2 fighter squadrons, 1 attack squadron, and 1 observation squadron from 1948 to 1959.

"He commanded All Weather Jet Fighter Squadron 102 from 1959 to 1960. Served in Attack Carrier USS Lexington as Air Operations Officer from 1960-1962. He retired from US Navy in 1968.

"He joined Auburn University as Assistant Professor of Aviation Management in 1968. Became Head of the program in 1973 until retirement as Associate Professor Emeritus in 1986." The Callans presently live on Beaver Lake in north west Arkansas.

Children

- 3,374 i Linda Kathryn Callan-b Sept 11, 1947
- 3,375 ii Patricia Evelyn Callan-b Dec 11, 1949
- 3,376 iii Rebecca Susan Callan-b Oct 16, 1953
- 3,377 iv Janis Leigh Callan-b Oct 10, 1955

3,285-MARY K CALLAN/ Allie W/ George M II/ William D Callen/ George A/ William Jr/ William Callen Sr

(45-51B)MARY KATHERINE CALLAN was born September 18, 1929, the daughter of Allie W and Eunice (Harmon) Callan. (51B)She graduated from high school in 1947 and attended Arkansas Tech at Russellville in 1947-1948.

On February 5, 1949 she married EDGAR LEE "BILL" NIGH who was born in 1927. (51B)"She was involved in cub scouting, girl scouting, school functions, band parents, La Sertoma Club, and church work. She started to work at the Fort Smith Public Library, January 4, 1965. Now is the assistant director.

"Bill was ill for several years with a heart condition. He had worked for Friden Company and then was in business for himself. He died May 2, 1983 from a heart attack.

Children

- 3,378 i William Lee Nigh-b Aug 19, 1951
- 3,379 ii Robert Lynn Nigh-b Jul 9, 1953
- 3,380 iii Elizabeth Ann Nigh-b Apr 1, 1956

3,286-EVERETT D CALLAN II/ Everett D/ George M II/ William D Callen/ George A/ William Jr/ William Callen Sr
(45-51A)EVERETT D CALLAN II was born in 1930, he married MELBA KETTEN.

Children

- i Cindy Callan-
- ii Lisa Callan-
- iii Thea Callan-
- iv Everett D Callan III-
- v Amy Callan-

3,287-NANCY A CALLAN/ Everett D/ George M II/ William D Callen/ George A/ William Jr/ William Callen Sr
(45-51A)NANCY A CALLAN married 1st JAS. COURTNEY and 2nd GORDON BROWN.

Children

3,381 i Crystal Courtney-
3,382 ii Kay Courtney

3,288-JUNA K WARREN/ Megell McCray/ Orlean Callan/ William D Callen/ George A/ William Jr/ William Callen Sr
(45-51A)JUNA K WARREN was born in 1946, she married JOHN HARWELL.

Children

i Lee Harwell-
ii Kay Harwell-

3,289-JUDITH A MCCRAY/ John N/ Orlean Callan/ William D Callen/ George A/ William Jr/ William Callen Sr
(45-51A)JUDITH A MCCRAY was born in 1940. In 1959 she married JACK WILEY who was born in 1933.

Children

i Tracey A Wiley-b 1960
ii Lori A Wiley-b 1961
iii Kathryn E Wiley-b 1967
iv Rebecca C Wiley-b 1972

3,290-LINDA J MCCRAY/ John N/ Orlean Callan/ William D Callen/ George A/ William Jr/ William Callen Sr
(45-51A)LINDA J MCCRAY was born in 1947. In 1968 she married BUCK A RUDD who was born in 1941.

Children

i Kyla R Rudd-b 1975
ii Adam M Rudd-b 1979

3,291-LEO L CALLEN/ Clinton W/ Henry D/ Socrates P/ Hannibal D/ Thomas/ William Callen Sr?

(60I)LEO LAROICE CALLEN was born September 17, 1933 in Fillmore, Oklahoma. On April 3, 1954 in Durant, OK. he married JOANN HARRISON who was born in Wapanucka, Oklahoma on January 10, 1935. JoAnn is the daughter of J.R. and Ruth B (Hobbie) Harrison. Leo is a farmer-rancher, Joann is a homemaker and secretary.

Children

3,383 i James Clinton Callen-b Feb 4, 1955
3,384 ii Cheryl Ann Callen-b Nov 14, 1958
3,385 iii Sharon Kay Callen-b Sept 3, 1963

3,292-GLENDA J CALLEN/ Clinton W/ Henry D/ Socrates P/ Hannibal D/ Thomas/ William Callen Sr?

(60I)GLENDA JACQUETTA CALLEN was born December 4, 1934, the daughter of Clinton W and Luella (Darbison) Callen. She married DAN LUCAS SULLIVAN. (60A)Dan was born April 17, 1934 in Albany, Oklahoma, the son of Loyd and Burnice (Brewer) Sullivan.

Children

- 3,386 i Alan Dan Sullivan-b Sept 10, 1955
3,387 ii Sherrie Lynn Sullivan-b Apr 12, 1956
twin iii Stacey Ann Sullivan-b Jan 6, 1968
twin iv Cinthia Sullivan-b Apr 13, 1970
v Cristina Sullivan-b Apr 13, 1970
vi Carrie Rachelle Sullivan-b Oct 25, 1971

3,293-JACKIE L CALLEN/ Clinton W/ Henry D/ Socrates P/ Hannibal D/
Thomas/ William Callen Sr?

(60I)JACKIE LYNN CALLEN was born November 14, 1938, the son of Clinton W and Luella (Darbison) Callen. (58)He "married JANIE FAYE DEAN on April 20, 1957. (60A)She was born June 18, 1942 in Durant, OK, the daughter of Dennis and Mary Jane (Tipton) Dean. (60I)Jackie and Janie live on their farm which is the old Callen homeplace."

Children

- 3,388 i Jackie Lynn Callen-b Apr 21, 1958
3,389 ii Steven Glenn Callen-b Sept 20, 1960
iii Tambra Denise Callen-b Feb 20, 1964
m MYRL DILBECK JR
3,390 iv Teresa Jane Callen-b Apr 21, 1970
v Tonja Lea Callen-b Oct 8, 1971

3,294-JUDY MAE CALLEN/ Clinton W/ Henry D/ Socrates P/ Hannibal D/
Thomas/ William Callen Sr?

(60I)JUDY MAE CALLEN was born August 22, 1942, the daughter of Clinton W and Luella (Darbison) Callen. She married "WILLIAM R "BILL" MORROW on October 9, 1959." (60A)Bill was born December 6, 1938 in Tishomingo, Oklahoma, the son of Robert T and Mary Bell (Marsha) Morrow. Bill is an auditor, they live in Edmond, OK.

Children

- i Gary Dale Morrow-b Sept 26, 1960
ii Lea Ann Morrow-b July 24, 1963 Oklahoma City
d May 29, 1979 buried Condon Grove Cemetery
iii Clinton Robert Morrow-b Nov 4, 1971

3,295-RANDEL JOHNSON/ Ona Callen/ Ernest L/ Socrates P/ Hannibal
D/ Thomas/ William Callen Sr?

(58)RANDEL JOHNSON "married DIXIE HIGGINBOTHAM..."

Children

- i Marlon Johnson-
ii Wendy Johnson-
iii Dede Johnson-
iv Nicholas Johnson-

3,296-JOYE J CALLEN/ Lonnie E/ Ernest L/ Socrates P/ Hannibal D/
Thomas/ William Callen Sr?
(58)JOYE JEAN CALLEN "married RALPH RAGAN..."

Children

- i Terry Ragan-
- ii Joni Ragan-

3,297-DALE CALLEN/ Lonnie E/ Ernest L/ Socrates P/ Hannibal D/
Thomas/ William Callen Sr?
(58)DALE CALLEN "married VERONICA KROPP..."

Children

- i Jill Callen-
- ii Dayla Callen-
- iii Whitney Leigh Callen-

3,298-MARGIE CALLEN/ Alvie/ Ernest L/ Socrates P/ Hannibal D/
Thomas/ William Callen Sr?
(58)"MARGIE CALLEN married ROY SHIPP. They had two children...
Later Margie married LLOYD DOTY. They have one son..."

Children

- i Darlene Shipp- m "has two sons"
- ii David Shipp- m
- iii Monty Doty-

3,299-LARRY CALLEN/ Alvie/ Ernest L/ Socrates P/ Hannibal D/
Thomas/ William Callen Sr?
(58)LARRY CALLEN "married MYRA KROPP..."

Children

- i Holly Callen-
- ii Lorri Callen-

3,300-PATSY LAWLEY/ Theresa Callen/ Ernest L/ Socrates P/ Hannibal
D/ Thomas/ William Callen Sr?
(58)PATSY LAWLEY "married BOB NELSON..."

Children

- i Melanie Nelson-
- ii Leslie Nelson-

3,301-GARY LAWLEY/ Theresa Callen/ Ernest L/ Socrates P/ Hannibal
D/ Thomas/ William Callen Sr?
(58)GARY LAWLEY "married PAT THOMPSON..."

Children

- i Gregg Lawley-
- ii Stephanie Lawley-
- iii Christa Lawley-
- iv Jay Lawley-

3,302-JERRY LAWLEY/ Theresa Callen/ Ernest L/ Socrates P/ Hannibal D/ Thomas/ William Callen Sr?

(58)JERRY LAWLEY "married DONNA CALHOUN..."

Only Child

3,391 i Jerry Lynn Lawley, Jr-

3,303-CLAYTON CALLEN JR/ Clayton/ Ernest L/ Socrates P/ Hannibal D/ Thomas/ William Callen Sr?

(58) CLAYTON "CLAY" CALLEN JR "married DORIS ADAMS. They have two sons."

Children

- i Tracey Callen-
- ii Kenny Callen-

3,304-NOVITA CALLEN/ Clayton/ Ernest L/ Socrates P/ Hannibal D/ Thomas/ William Callen Sr?

(58)"NOVITA CALLEN married PAT PATRICK..."

Children

- i Kelly Patrick-
- ii Tiffany Patrick-

3,305-ONECA CALLEN/ Clayton/ Ernest L/ Socrates P/ Hannibal D/ Thomas/ William Callen Sr?

(58)"ONECA CALLEN married JIM SHAW..."

Children

- i Tammy Shaw-
- ii Heidi Shaw-

3,306-DON REED/ Orelia Callen/ Ernest L/ Socrates P/ Hannibal D/ Thomas/ William Callen Sr?

(58)DON REED "married SUE HOUSER..."

Children

- i Kelli Reed-
- ii Kerri Reed-
- iii Jeff Reed-
- iv Kristi Reed-

3,307-WILBUR D CALLEN/ Carl V/ Roscoe J/ Buenos A/ Augustus G/
Thomas/ William Callen Sr?

(60E)WILBUR DEANE CALLEN was born in Jerome, Idaho on September 16, 1933. He married PHYLLIS LOUISE PINARD in Long Beach, California on September 8, 1951. Phyllis was born in Whittier, California on November 13, 1933. Wilbur is a truck driver.

Children

- i Russell Deane Callen-b Nov 24, 1953
- ii Debra Elaine Callen-b Oct 17, 1955
- iii Cheryl Diane Callen-b June 22, 1959
- iv Janice Louise Callen-b Feb 13, 1962

3,308-JERRY R CALLEN, JR/ Jerry R/ Thomas/ Buenos A/ Augustus G/
Thomas/ William Callen Sr?

(60D)JERRY RAY CALLEN, JR. was born in Corona, California on November 18, 1953. On February 21, 1976 he married STACY LYNNE WILLIAMS who was born in Twin Falls, Idaho. Jerry is a farmer, Stacy is a homemaker and mother.

Children

- i Clifford Ray Callen-b Feb 29, 1980
- ii Clint William Callen-b June 14, 1985
- iii Jaime Leigh Callen-b Mar 23, 1988

3,309-SANDRA L CALLEN/ Jerry R Sr/ Thomas/ Buenos A/ Augustus G/
Thomas/ William Callen Sr?

(60D)SANDRA LOUISE CALLEN was born January 11, 1955 in Twin Falls, Idaho. On July 26, 1973 in Logan, Utah she married DENNIS GLEN CAPPS. Dennis was born in Rigby, Idaho on October 24, 1950. Dennis works in hay and grain transportation, Sandra is a homemaker and mother.

Children

- i Anne Marie Capps-b May 3, 1975
- ii Sean Thomas Capps-b Oct 29, 1976
- iii Jenny Lynn Capps-b Aug 6, 1979
- iv Bradley Dennis Capps-b May 6, 1981
- v Todd Christopher Capps-b Sept 4, 1982
- vi Crystal Lee Capps-b Mar 2, 1984

3,310-TIMOTHY J CALLEN/ Jerry R Sr/ Thomas/ Buenos A/ Augustus G/
Thomas/ William Callen Sr?

(60D)TIMOTHY JAMES CALLEN was born in Jerome, Idaho on March 11, 1957. On October 21, 1978 in Jerome, Idaho he married GAYELYNN ARDEN GRIFFIN. Gayelynn was born March 19, 1959 in Twin Falls, Idaho. Timothy is a farmer, Gayelynn is a homemaker and mother.

Children

- i Brooke Arden Callen-b May 5, 1979
- ii Summer Marie Callen-b Nov 30, 1981

- iii Brandi Lynn Callen-b Aug 19, 1983
- iv Candice Aubrey Callen-b Aug 25, 1986
- v Sarah Louise Callen-b Jan 23, 1989

3,311-GREGORY T CALLEN/ Jerry R Sr/ Thomas/ Buenos A/ Augustus G
Thomas/ William Callen Sr?

(60D)GREGORY THOMAS CALLEN was born October 3, 1958 in Jerome,
Idaho. On March 17, 1984 he married LISA MARIE SCHEER who was born
July 3, 1965 in Jerome, Idaho. Gregory does custom farming, Lisa is
a bookkeeper and homemaker.

Children

- i Callie Marie Callen-b Oct 26, 1984
- ii Thomas Jerry Callen-b Jan 24, 1987
- iii Joshua Michael Callen-b Aug 24, 1988

3,312-MELONIE A CALLEN/ Jerry R Sr/ Thomas/ Buenos A/ Augustus G/
Thomas/ William Callen Sr?

(60D)MELONIE ANN CALLEN was born September 20, 1960 in Jerome,
Idaho. On August 27, 1981 in Logan, Utah she married MARK SAMUEL
SWENSON. Mark was born July 26, 1959 in Twin Falls, Idaho. Melonie
is a homemaker and mother, Mark is a business administrator at the
Seattle Academy of Social Sciences.

Children

- i Mark Jared Swenson-b July 4, 1982 Provo, Utah
- ii Jacob Dan Swenson-b May 12, 1984 Twin Falls, Id
- iii James Alen Swenson-b Jan 3, 1989 Washington state

LINE OF WILLIAM CALLEN SR - 8TH GENERATION

3,313-ELIZABETH A EVERSULL/ Beverly H/ Jewell E Kirkpatrick/ John T/ Samuel A/ Elizabeth Callen/ John/ William Callen Sr

(50G)ELIZABETH ANN EVERSULL was born on September 24, 1942, she is the daughter of Beverly H and Lucille (Harris) Eversull. In 1961 Elizabeth married RALPH MEREDITH, by whom she had one son. Ralph died in 1963.

Elizabeth married 2nd in 1966 to BERNARD MEREDITH, by whom she had a daughter. They were divorced and Elizabeth married CHARLES KELLEY on December 12, 1981 in Morgantown, W. Va.

Child of Ralph

i Gregory Meredith-b Feb 4, 1963

Child of Bernard

ii Moira Meredith-b Nov 11, 1968

3,314-RUBY M BROWN/ John S/ Mary A Tinsley/ Frances A Kirkpatrick/ Samuel A/ Elizabeth Callen/ John/ William Callen Sr

(50F)RUBY MAE BROWN was born September 9, 1917 in Natchitoches, Louisiana. She is the daughter of John S and Mary (Funderburk) Brown. On November 12, 1902 in Catahoula Parish, La she married WILLIAM CRAWFORD.

(50A)Ruby studied at Northwestern La. College, L.S.U., N.Y.U., U. of Southern Miss. and has earned her Bachelor and Masters Degrees. She is a retired University Professor. She is a member of the Monroe Garden Club, Fort Miro Book Club, Retired Teachers Assn., United Daughters of the Confederacy, D.A.R., Phi Mu, and Kappa Gamma. She is Baptist in religion.

(50F)William died April 28, 1975 and is buried in Abbeville, La. Ruby married 2nd CLARENCE BALL who was born September 22, 1917.

Only Child

3,392 i Linda Sue Crawford-b Dec 28, 1944

3,315-RUBY L BENNETT/ Sarah F Brown/ Mary A Tinsley/ Frances A Kirkpatrick/ Samuel A/ Elizabeth Callen/ John/ William Callen Sr

(50A)RUBY LEE BENNETT was born in 1924. She is the daughter of Sarah F (Brown) and Floyd Bennett. Ruby was married first to WILFORD A PARKER, she was married second to V.L. PREWITT. She is living in Anacoco, La.

Child (May be partial list)

3,393 i Wanda Parker-

3,316-DOUGLAS L WILLIAMSON/ George L/ Sarah C Tinsley/ Frances Kirkpatrick/ Samuel A/ Elizabeth Callen/ John/ William Callen Sr
(49)"DOUGLAS LEROY WILLIAMSON, son of George and C Belle (Bennett) Williamson, was born February 22, 1916, in Louisiana. He married TRESSIE MAY MUNDAY, daughter of Harvey Lee Munday and Alice Virginia Gentry, and two sons were born. Douglas Williamson [retired as] Assistant Principal and commerce teacher at Simpson High School. He coached the boys basketball team for 27 years before giving it up."

Children

3,394 i Gordon Williamson-b Nov 15, 1941
ii Randal Douglas Williamson-b July 31, 1953

3,317-LUTHER G WILLIAMSON/ George L/ Sarah C Tinsley/ Frances Kirkpatrick/ Samuel A/ Elizabeth Callen/ John/ William Callen Sr
(49)"LUTHER GEORGE WILLIAMSON, son of George and C Belle (Bennett) Williamson, was born April 28, 1920, in Louisiana. He married ALSIE DENNIS, daughter of George Dennis and Letha (Bennett)... and they have one adopted daughter."

Child

i Carol Sue Williamson-

3,318-DORIS K WILLIAMSON/ Rufus S/ Sarah Tinsley/ Frances Kirkpatrick/ Samuel A/ Elizabeth Callen/ John/ William Callen Sr
(50A)DORIS KATHRYN WILLIAMSON was born November 11, 1921 in Vernon Parish, Louisiana. On October 22, 1943 in Port Arthur, Texas, she married LLOYD PRENTICE NELSON. Lloyd was born on May 9, 1921, in Beauregard Parish, La, the son of Jasper Newton and Adaline (Ashworth) Nelson.

Doris has an Associate Degree in Business Administration from Lamar University and worked ten years as a secretary. She is a housewife, and a hospital volunteer, and a member of the D.A.R. (Daughters of the American Revolution). Doris enjoys bridge and genealogy, and has contributed much to the research on the line of William Sr.

Lloyd earned his B.S. degree in Engineering from Texas A&M University and is a retired engineer for Mobil Oil Corporation. He served in the Naval Air Corps in WWII.

Children

3,395 i Randall Lloyd Nelson-b Jan 27, 1950
3,396 ii David William Nelson-b Apr 10, 1952

3,319-RUFUS S WILLIAMSON, JR/ Rufus Sr/ Sarah Tinsley/ Frances Kirkpatrick/ Samuel A/ Elizabeth Callen/ John/ William Callen Sr
(50A-49)RUFUS SAMUEL WILLIAMSON JR called "Bubba" was born November 27, 1923 in Port Arthur, Texas, the son of Rufus S and A Blanche (Dennis) Williamson.

He received a B.S. in Civil Engineering from Texas A&M University. He served in the U.S. Navy from 1942 to 1946, 30 months in the South Pacific. He is retired from the Texas Highway Department in Austin, Texas where he was an Engineer of Design Operations.

He married CAROL McGLOTHLIN in Port Arthur, Tx, on February 17, 1952. They divorced and he married JEANNE PEARSON MAY April 20, 1973. Jeanne had previously been married and had one son, Benjamin.

Rufus is a member of the Ben Hur Shrine Temple, Postmaster of Colorado Lodge No #96 & AM and Austin Scottish Rite. He is a member of the choir of the Memorial Methodist Church in Austin, Tx, and Ben Hur Chanters.

Only Child

i Charles W "Chuck" Williamson-b Aug 25, 1953 Tx

3,320-L FRANCIS WILLIAMSON/ Rufus Sr/ Sarah Tinsley/ Frances A Kirkpatrick/ Samuel A/ Elizabeth Callen/ John/ William Callen Sr
(50A-49)LILLIE FRANCIS WILLIAMSON was born October 26, 1928 in Port Arthur, Texas. On January 31, 1948 she married DONALD BEVERLY LAUVE. Donald was born October 14, 1928 in Nederland, Texas, son of Herbert and Juanita Lauve.

Francis is a retired executive secretary, and is presently a volunteer secretary for a law group. She is also a volunteer at St. Lukes/Texas Heart Institute. She is a member of the Genealogical Research Society of New Orleans and the Fort Bend D.A.R. She enjoys genealogy research and writing historical material. Donald is Texas Vice-president of the Apprenticeship Directors and Director of three area vocational schools.

Children

3,397 i Sherry Lauve-b Oct 8, 1949
ii Melanie Diane Lauve-b Dec 19, 1951 d Dec 1, 1981
3,398 iii Beverly Louise Lauve-b June 29, 1956

3,321-LEROY WILLIAMSON/ Eugene L Williamson/ Sarah C Tinsley/ Frances A Kirkpatrick/ Samuel A/ Elizabeth Callen/ John/ William Callen Sr
(49)"LEROY WILLIAMSON, son of Eugene and Thelma (Hicks) Williamson, was born September 17, 1924. He married ALICE WILLIAMS."

Children

i Michael Williamson-
ii Larkin Williamson-
iii Susan Williamson-

3,322-**RONALD L WILLIAMSON**/ Eugene L Williamson/ Sarah C Tinsley/
Frances A Kirkpatrick/ Samuel A/ Elizabeth Callen/ John/ William
Callen Sr

(49)"**RONALD LOY WILLIAMSON**, son of Eugene and Thelma (Hicks)
Williamson, married **RUTHIE DAVIS**, daughter of Alford C Davis."

Children

- i Danny Williamson-
- ii Omanda Williamson-

3,323-**CHARLOTTE B JACKSON**/ Frances E Williamson/ Sarah C Tinsley/
Frances Kirkpatrick/ Samuel A/ Elizabeth Callen/ John/ William
Callen Sr

(50A-49)**CHARLOTTE BLANCHE JACKSON** was born on July 31, 1918, she
was the daughter of F Effie (Williamson) and J Edgar Jackson. On
April 30, 1937 she married **OLAN ELMO WALDING**. Charlotte died
November 19, 1987, and is buried in Mt Pleasant Cemetery, Simpson,
Louisiana.

Child

- i James Sherwin Walding-b Jan 29, 1939
married **BETTY SHANNON**

3,324-**S CHARLENE WILLIAMSON**/ Charley E/ Sarah C Tinsley/ Frances
Kirkpatrick/ Samuel A/ Elizabeth Callen/ John/ William Callen Sr

(49)**SALLIE CHARLENE WILLIAMSON**, daughter of Charley Edgar
Williamson and Lena Cook, was born August 7, 1931. She married
JERRELL EARNEST BRADFORD on February 2, 1951."

Children

- i Judy Marie Bradford-b Feb 16, 1958
- ii Lee Edward Bradford-b Dec 28, 1959
- iii Troy Lynn Bradford-b Apr 4, 1964

3,325-**ROBERT LEON WILLIAMSON**/ Charley E/ Sarah C Tinsley/ Frances
Kirkpatrick/ Samuel A/ Elizabeth Callen/ John/ William Callen Sr

(49)"**ROBERT LEON WILLIAMSON**, son of Charley Edgar Williamson and
Lena Cook, was born May 4, 1935. He married **MYRTLE MARTIN** on May 4,
1956." He is retired from Chevron in Port Arthur, Tx.

Children

- i Ellyn Ann Williamson-b Mar 14, 1958
- ii Martin Allen Williamson-b Nov 20, 1959
- iii Phillip Wayne Williamson-b Dec 8, 1961
- iv Susan Kay Williamson-b Jun 22, 1963

3,326-**EDGAR H WILLIAMSON**/ Charley E/ Sarah C Tinsley/ Frances
Kirkpatrick/ Samuel A/ Elizabeth Callen/ John/ William Callen Sr

(49)"**EDGAR HAROLD WILLIAMSON**, son of Charley Edgar Williamson and
Lena Cook, was born October 21, 1941. He married **KAREN DREIBELBIS**
on December 10, 1961."

Children

- i Lori Ann Williamson-b Jan 7, 1963
- ii Timothy Williamson-b Sept 26, 1966
- iii Paul Williamson-b May 24, 1968

3,327-BOBBIE F ANTILLEY/ Bertha N/ Sarah C Tinsley/ Frances Kirkpatrick/ Samuel A/ Elizabeth Callen/ John/ William Callen Sr
(49)"BOBBIE FAYE ANTILLEY, daughter of James Franklin Antilley and Bertha Naomi Williamson, was born September 6, 1929. She married WILLIAM HOLLINGER on November 10, 1956."

Children

- i Daniel Lee Hollinger-b Dec 10, 1957
- ii Kenneth Wayne Hollinger-b Oct 30, 1960

3,328-RUDOLPH ANTILLEY/ Bertha N/ Sarah C Tinsley/ Frances Kirkpatrick/ Samuel A/ Elizabeth Callen/ John/ William Callen Sr
(49)"RUDOLPH ANTILLEY, son of James Franklin Antilley and Bertha Naomi Williamson, was born August 26, 1934. He married BETTY CHARLENE WEST on December 30, 1955." Betty is deceased.

Children

- i Deborah Lynn Antilley-b Apr 3, 1957
- ii Jimmy Dain Antilley-b May 6, 1959
- iii Mark Wade Antilley-b Aug 11, 1960

3,329-AUBREY A ANTILLEY/ Bertha N/ Sarah C Tinsley/ Frances Kirkpatrick/ Samuel A/ Elizabeth Callen/ John/ William Callen Sr
(49)"AUBREY ALLEN ANTILLEY, son of James Franklin Antilley and Bertha Naomi Williamson, was born July 10, 1936. He married DELORES CASTILLE in June 1964."

Only Child

- i Gary Allen Antilley-b June 6, 1965

3,330-JAMES D JOHNSON/ Mary A Glass/ Charles R/ William J F/ Margaret F Callen/ Ross/ John/ William Callen Sr
(50D)JAMES DAVID JOHNSON was born on August 31, 1944. On February 9, 1968 he married CHARLOTTE ANN (JACOBS) MORRIS who was born on March 9, 1948.

Children

- S/S Michael Gregg Morris-b May 29, 1963
- S/D Sheila Kay Morris-b Apr 30, 1964
- i Donna Gaye Johnson-b Oct 2, 1968
- ii Olivia Ann Johnson-b Feb 11, 1971

3,331-MARTHA L JOHNSON/ Mary A Glass/ Charles R/ William J F/
Margaret F Callen/ Ross/ John/ William Callen Sr
(50D)MARTHA LYNN JOHNSON was born January 29, 1948. On March 11,
1967 she married JOHN GORDON JONES who was born July 25, 1947.

Children

- i Michael Wayne Jones-b Apr 13, 1969
- ii John Alan Jones-b July 7, 1970

3,332-CAROL M GLASS/ Charles N/ Charles R/ William J F/ Margaret F
Callen/ Ross/ John/ William Callen Sr
(50D)CAROL MARGARET GLASS was born July 29, 1949. On May 21, 1969
she married MARK MURRAY who was born June 9, 1948. Carol was
divorced in November of 1984. On June 22, 1985 Carol married
STEPHEN JOHN PRATT, who was born June 22, 1950,

Children

- i Drew David Murray-b Jul 29, 1971
- ii Megan Lane Murray-b Sep 20, 1975
- iii Keeland Charles Murray-b May 18, 1979

3,333-ZYLE R GLASS/ Charles N/ Charles R/ William J F/ Margaret F
Callen/ Ross/ John/ William Callen Sr
(50D)ZYLE RUSH GLASS was born in Houston, Texas on October 14,
1951. On September 29, 1970 he married JILL WILKERSON who was born
January 7, 1952. They were divorced in 1976.

Only Child

- i Braxton Garret Glass-b Dec 3, 1975

3,334-LINDA A GLASS/ Charles N/ Charles R/ William J F/ Margaret F
Callen/ Ross/ John/ William Callen Sr
(50D)LINDA ANN GLASS was born in Maracaibo, Venezuela on June 9,
1956. On June 21, 1980 she married HENRY LAWRENCE MEGAN III who was
born October 25, 1954.

Children

- i Kristin Kerry Megan-b May 13, 1981
- ii Katherine Lynn Megan-b Oct 5, 1982
- iii Gregory Edward Megan-b Jul 11, 1984

3,335-NANCY E GLASS/ Charles N/ Charles R/ William J F/ Margaret F
Callen/ Ross/ John/ William Callen Sr
(50D)NANCY ELLEN GLASS was born September 23, 1957, the daughter
of Charles N and Ruby (Hollingsworth) Glass. She was born in
Houston, Texas.

3,336-RUE A GLASS/ Charles N/ Charles R/ William J F/ Margaret F Callen/ Ross/ John/ William Callen Sr

(50D)RUE ANN GLASS was born in Maracaibo, Venezuela on January 16, 1959. She is the daughter of Charles N and Ruby (Hollingsworth) Glass.

3,337-CHARLES M CHAMBERS/ Billie B/ Velma S Glass/ William J F/ Margaret F Callen/ Ross/ John/ William Callen Sr

(50D)CHARLES MICHAEL "MIKE" CHAMBERS was born December 9, 1943. On December 10, 1965 he married LUCY MARIE SALMON who was born December 10, 1947. "This marriage was dissolved by divorce, and on December 12, 1970, [Charles] married JUANITA MARIE GALLATIN (born June 27, 1949)."

Child of Lucy

i Julie Kay Chambers-b Apr 5, 1967

Children of Juanita

ii Juanita Michele Chambers-b Apr 28, 1972

iii Carrie Melissa Chambers-b Mar 12, 1974

3,338-BRIAN A CHAMBERS/ Billie B/ Velma S Glass/ William J F/ Margaret F Callen/ Ross/ John/ William Callen Sr

(50D)BRIAN ALLEN CHAMBERS (called Pat) was born February 7, 1946. He married MARJORIE LOUISE GRIFFITH who was born February 25, 1947. Brian died February 6, 1975. Marjorie has remarried and lives in Houston.

Only Child

i Shelly Renee Chambers-b Sept 16, 1968

3,339-GARY G CHAMBERS/ Billie B/ Velma S Glass/ William J F/ Margaret F Callen/ Ross/ John/ William Callen Sr

(50D)GARY GENE CHAMBERS was born April 27, 1953. On August 8, 1972 he married GINNEY LEE WILLS. No children were born of this marriage, which was dissolved by divorce in the spring of 1978. On February 16, 1980 Gary Gene Chambers was married to DEBORAH LYNN SPRIGGS.

Children

i Jessica Elizabeth Chambers-b Mar 21, 1983

ii Justin Allen Chambers-b Jul 2, 1985

3,340-MOLLY A CHAMBERS/ Billie B/ Velma S Glass/ William J F/ Margaret F Callen/ Ross/ John/ William Callen Sr

(50D)MOLLY ANN CHAMBERS was born May 27, 1956. On January 9, 1976 she married RICHARD LYNN COURSEY who was born February 21, 1954.

Children

i Richard Lynn Coursey, Jr-b Dec 15, 1978

ii Daniel Lee Coursey-b Aug 5, 1982

3,341-BARBARA G CHAMBERS/ Joe C/ Velma S Glass/ William J F/
Margaret F Callen/ Ross/ John/ William Callen Sr
(50D)BARBARA GAY CHAMBERS was born February 5, 1944. On August 8,
1962 she married ROBERT CHARLES PALMER. "This marriage was
dissolved by divorce, and on March 6, 1969, Barbara Gay married
THOMAS PETER IRWIN, JR (born November 14, 1939)."

Children

- i Nanette Rae Palmer-b Sept 13, 1963
- ii Stephanie Anne Palmer-b Jan 11, 1965
- iii Kathleen Regina Irwin-b Oct 14, 1970
- iv Melanie Mae Irwin-b Nov 14, 1972

3,342-DIANNE E CHAMBERS/ Joe C/ Velma S Glass/ William J F/
Margaret F Callen/ Ross/ John/ William Callen Sr
(50D)DIANNE ELIZABETH CHAMBERS was born December 29, 1946. On
February 17, 1968 she married GARY LEONARD DONALDSON who was born
June 26, 1941.

Only Child

- i John Paul Donaldson-b Dec 23, 1968

3,343-MARK CHAMBERS/ Joe C/ Velma S Glass/ William J F/ Margaret F
Callen/ Ross/ ohn/ William Callen Sr
(50D)MARK CHAMBERS (no middle name) was born July 23, 1953. On
July 16, 1979 he married MARGARET ELLEN GOODMAN who was born April
12, 1959.

Children

- i Jamie Ellen Chambers-b July 3, 1985
- ii Kristen Sheppard Chambers-b Oct 11, 1987

3,344-WILLIAM M WARREN, JR/ R Carolyn Glass/ Wicker I/ William J
F/ Margaret F Callen/ Ross/ John/ William Callen Sr
(50D)WILLIAM MICHAEL WARREN, JR was born June 8, 1947 in Bryan,
Texas. On June 5, 1968 he married ANN CANDLER McLEOD who was born
July 14, 1947.

Children

- (All born in Birmingham, Alabama)
- i William Powers Warren-b Aug 23, 1970
 - ii Laura Ann Warren-b Aug 6, 1973
 - iii Amy Lynn Warren-b July 26, 1976

3,345-CHARLES W WARREN/ R Carolyn Glass/ Wicker I/ William J F/
Margaret F Callen/ Ross/ John/ William Callen Sr
(50D)CHARLES WICKER WARREN was born November 9, 1948 in Bryan,
Texas. On June 10, 1971 he married MARY KATHRYN LAWRENCE who was
born May 21, 1949.

Children

(All born in Atlanta, Georgia)

- i Bryan Wicker Warren-b Jun 11, 1977
- ii Stephen Thomas Warren-b Aug 26, 1983
- iii Carolyn Elizabeth Warren-b Dec 17, 1987

3,346-JOHN W WARREN/ R Carolyn Glass/ Wicker I/ William J F/
Margaret F Callen/ Ross/ John/ William Callen Sr
(50D)JOHN WELLS WARREN was born October 4, 1952 in Bryan, Texas.
On September 9, 1977 he married LAURA LEIGH WILLIAMSON who was born
June 17, 1955.

Children

- i Jennifer Meadows Warren-b Nov 22, 1979
Montgomery, Al
- ii Margaret Elizabeth Warren-b Jul 21, 1983
Fayette, Al

3,347-JAMES P WARREN/ R Carolyn Glass/ Wicker I/ William J F/
Margaret F Callen/ Ross/ John/ William Callen Sr
(50D)JAMES PERRIN WARREN was born July 2, 1954 (a fraternal twin)
in Bryan, Texas. On October 15, 1983 in DeBilt, Holland, he married
YOLANDA DORHOUT MEES who was born June 24, 1957.

Children-born Lexington, Va

- i Sylvia Emilie Warren-b May 27, 1987
- ii Eline Marlene Warren-b Oct 18, 1988

3,348-JOSEPH R WARREN/ R Carolyn Glass/ Wicker I/ William J F/
Margaret F Callen/ Ross/ John/ William Callen Sr
(50D)JOSEPH ROBERT WARREN was born July 2, 1954 (a fraternal twin)
in Bryan, Texas. On April 20, 1985, in Auburn, Alabama, he married
LEAH STRICKLAND who was born April 16, 1960.

Only Child

- i Kate Marie Warren-b Jan 5, 1989 Auburn, Alabama

3,349-ANDREW L WARREN/ R Carolyn Glass/ Wicker I/ William J F/
Margaret F Callen/ Ross/ John/ William Callen Sr
(50D)ANDREW LOUIS WARREN was born January 2, 1961 in Auburn,
Alabama. He is the youngest son of Carolyn (Glass) and William M
Warren.

3,350-REBECCA J GLASS/ Joe L/ Wicker I/ William J F/ Margaret F
Callen/ Ross/ John/ William Callen Sr
(50D)REBECCA JANE GLASS was born December 1953. On August 25,
1973 she married TERRY DON RAY who was born November 15, 1951.

Children

- i Courtney Jane Ray-b Sept 21, 1979
- ii Eric Brandon Ray-b Apr 6, 1982

3,351-CYNTHIA L GLASS/ Joe L/ Wicker I/ William J F/ Margaret F Callen/ Ross/ John/ William Callen Sr
(50D)CYNTHIA LYNN GLASS was born December 20, 1954, the daughter of Joe L and Jonell (Seale) Glass. On August 23, 1975 she married ARTHUR PAUL RICH who was born February 26, 1954.

Children

- i Arthur Paul Rich, Jr-b Mar 28, 1980
- ii Kimberley Michelle Rich-b Oct 1, 1983

3,352-JOE L GLASS, JR/ Joe L/ Wicker I/ William J F/ Margaret F Callen/ Ross/ John/ William Callen Sr
(50D)JOE LOUIS GLASS, JR was born March 22, 1958, the son of Joe L and Jonell (Seale) Glass. On July 19, 1986 he married KELLIE JEANNE KIRKPATRICK who was born July 17, 1963.

3,353-KAY A KNIGHT/ Joseph S/ Claude K/ Malena Kirkpatrick/ William L/ Nancy Callen/ John/ William Callen Sr
(50H)KAY ANGELA KNIGHT was born July 26, 1955, the daughter of Joseph S Knight. She married DAVID MARTIN, and 2nd to F. RAY BOLEY.

Children

- i Alexander Knight Martin-
- ii Angela Boley-
- iii Robert Boley-

3,354-VICKI E KNIGHT/ Joseph S/ Claude K/ Malena Kirkpatrick/ William L/ Nancy Callen/ John/ William Callen Sr
(50H)VICKI ELIZABETH KNIGHT was born August 31, 1957. She married JACK CALLEN a distant cousin. Her second husband is MITCH TAYLOR.

Children

- i Emily Callen-
- ii Kathryn Ivy Taylor-

3,355-JOSEPH F WALTERS, JR/ Ethel C Murphree/ Willie C Purcell/ Mary E Callen/ Thomas A/ William III/ James/ William Callen Sr
(55B)JOSEPH FRANKLIN WALTERS, JR was born in 1929, the son of Ethel C (Murphree) and Joeseph F Walters, Sr. In 1956 he married ALICE BERRY who was born in 1935.

Children

- 3,399 i Elizabeth Murphree Walters-b 1947
- 3,400 ii Ellen Claire Walters-b 1959
- iii Joseph Franklin Walters III-b 1963

3,356-MARY G WALTERS/ Ethel C Murphree/ Willie C Purcell/ Mary E Callen/ Thomas A/ William III/ James/ William Callen Sr
(55B)MARY GENE WALTERS was born in 1931, the daughter of Ethel C (Murphree) and Joseph F Walters Sr. In 1951 she married ROBERT E EZELL who was born in 1929, they were divorced in 1977.

Children

3,401 i Barbara Gene Ezell-b 1952
3,402 ii Norma Joe Ezell-

3,357-JOHN D ABERNATHY III/ John D/ Selma Purcell/ Mary E Callen/ Thomas A/ William III/ James/ William Callen Sr
(55B)JOHN DANIEL ABERNATHY III was born in 1937, the son of John D and Elsie K (Sander) Abernathy. He was first married in 1961 to MARTHA GAY HARVEY who was born in 1940. They were divorced in 1975. John married 2nd in 1976 to ALICE JOANNE PAUL who was born in 1947.

Children

i John Daniel Abernathy IV-b 1966
ii Steven Harvey Abernathy-b 1969

3,358-EUGENE S ABERNATHY/ John D/ Selma Purcell/ Mary E Callen/ Thomas A/ William III/ James/ William Callen Sr
(55B)EUGENE SANDER ABERNATHY was born in 1940, the son of John D and Elsie K (Sander) Abernathy. In 1966 he married LINDA TRITT who was born in 1941.

Children

i Eugene Sander Abernathy, Jr-b 1967
ii William Charles Abernathy-b 1969
iii Andrew Abernathy-b 1971

3,359-AVERIL COLLINS/ Meredith P/ Ruby E Purcell/ Mary E Callen/ Thomas A/ William III/ James/ William Callen Sr
(55B)AVERIL COLLINS was born in 1942, the daughter of Meredith P and Annie M (McWhirter) Collins. She married DONALD W LASHLEY, they are now divorced.

Children

i Peter Stewart Lashley-b 1969
ii Sarah Brooke Lashley-b 1970

3,360-ROBERT M COLLINS/ Milton M/ Ruby E Purcell/ Mary E Callen/ Thomas A/ William III/ James/ William Callen Sr
(55B)ROBERT MILTON COLLINS was born in 1929, the son of Milton M and Anastasia (Powers) Collins. He married 1st to GAIL BRITTAIN who was born in 1938, they were divorced in 1978. Robert married 2nd in 1983 to AN DYER CLANTON who was born in 1943.

Children

- i James Milton Collins-b 1962
- ii Patricia Perkins Collins-b 1964
- iii Robert Purcell Collins-b 1965

3,361-PATRICIA P COLLINS/ Milton M/ Ruby E Purcell/ Mary E Callen/
Thomas A/ William III/ James/ William Callen Sr
(55B)PATRICIA POWERS COLLINS was born in 1933. In 1956 she
married JOHN W DURR who was born in 1931.

Children

- i James Judkins Durr II-b 1966
- ii Lucy Powers Durr-b 1967

3,362-MILDRED E COLLINS/ William B/ Ruby E Purcell/ Mary E Callen/
Thomas A/ William III/ James/ William Callen Sr
(55B)MILDRED ELIZABETH COLLINS was born in 1939, the daughter of
William B and Mildred E (Cade) Collins. She was married the second
time in 1968 to JAMES BRADLEY.

Children

- i William Meredith Bradley-b 1970
- ii Jonathan Dalton Bradley-b 1974

3,363-SARAH M COLLINS/ William B/ Ruby E Purcell/ Mary E Callen/
Thomas A/ William III/ James/ William Callen Sr
(55B)SARAH MARGARET COLLINS was born in 1947. She married TERRY
SCHENZ in 1969.

Children

- i Margaret Elizabeth Schenz-b 1978
- ii Sarah Katherine Schenz-b 1980

3,364-HARRIETT E KNOX/ T Bernice Purcell/ Thomas M/ Mary E Callen/
Thomas A/ William III/ James/ William Callen Sr
(55B)HARRIETT ETHEL KNOX was born in 1938, the daughter of T
Bernice (Purcell) and Wyckliffe A Knox. In 1961 she married SIDNEY
STETSON FLEMING III, they divorced. "Hatsy" married 2nd DAVID PENIX
ca 1986.

Children

- i Stetson Austin Fleming-b 1965
- ii Kevin Knox Fleming-b 1967
- iii Kathleen Byrnece Fleming-b 1972

3,365-WYCKLIFFE A KNOX/ T Bernice Purcell/ Thomas M/ Mary E
Callen/ Thomas A/ William III/ James/ William Callen Sr
(55B)WYCKLIFFE AUSTIN KNOX, JR was born in 1940, the son of T
Bernice (Purcell) and Wyckliffe A Knox. In 1966 he married DOROTHY
SHELL HARDMAN who was born in 1944.

Children

- i Wyckliffe Austin Knox III-b 1969
- ii Dorothy Shell Knox-b 1971
- twin iii John Hardman Knox-b 1976
- twin iv Davis Purcell Knox-b 1976

3,366-CAROL A PURCELL/ William W R/ Clare/ Mary E Callen/ Thomas A/ William III/ James/ William Callen Sr

(55B)CAROL ANN PURCELL was born March 19, 1939, the daughter of Col. "Woody" Purcell and Caroline R (Gray) Purcell. On November 20, 1965 Carol married BRUCE vonR. WILSON who was born August 16, 1928 in Cleveland, Ohio. He was a graduate of Yale University (engineering) Phi Beta Kappa, and he was director of Purchasing for the Standard Products Co of Cleveland. Bruce died 3 years later on September 6, 1968 and is buried in Lakeview Cemetery, Cleveland, Ohio. There were no children of this marriage.



TIM, CAROL, TERRY, GWEN

In 1970 Carol married 2nd to TIMOTHY EVAN STEVENS who was born April 19, 1939 in Akron, Ohio. Tim is the son of Dorothy and Edward Evan Stevens of Mansfield, Oh. Tim is a graduate of Case Institution of Technology (chemical engineering) and is employed by B.F. Goodrich.

Tim and Carol live in Hudson, Ohio. Carol has helped with research and information shared in this book.

Children

- S/S Randall Evan Stevens-b May 2, 1965
- S/D Wendy Kaye Stevens-b Aug 13, 1967
- 3,403 i Terrence Clare Stevens-b Sept 22, 1971
- 3,404 ii Gwen Rankin Stevens-b Oct 20, 1973

3,367-WILLIAM W R PURCELL, JR/ William W R/ Clare/ Mary E Callen/ Thomas A/ William III/ James/ William Callen Sr

(55B)WILLIAM "BILL" WOOD ROWE PURCELL, JR was born September 20, 1942, the son of Col "Woody" Purcell and Caroline R (Gray) Purcell. In 1965 he married ROSEMARY FOWLER who was born in 1943, they were divorced in 1972. He married again on April 5, 1975 to BARBARA MEAD who was born May 20, 1951.

Children of Rosemary

- 3,405 i Stacy June Purcell-b June 28, 1968
- ii Glenn Austin Purcell-b Sept 23, 1970

Children of Barbara

- iii Matthew Mead Purcell-b July 24, 1978
- iv Sarah Burnett Purcell-b Sept 2, 1982



MATTHEW, BARB, BILL, SARAH

3,368-JOAN A PURCELL/ John R/ Clare/ Mary E Callen/ Thomas A/
William III/ James/ William Callen Sr

(55B)JOAN ALICE PURCELL was born in 1941, the daughter of John R
and Lois E (Waits) Purcell. In 1964 she married WILLIAM C MORRIS
who was born in 1926, they were divorced in 1979. In 1981 Joan
remarried JOHN "JACK" HIXON who was born in 1945.

Children

- i John Clinton Morris-b 1965
- ii David Michael Morris-b 1967

3,369-DOUGLAS C PURCELL/ John R/ Clare/ Mary E Callen/ Thomas A/
William III/ James/ William Callen Sr

(55B-55C)DOUGLAS CLARE PURCELL was born in 1946, the son of John R
and Lois E (Waits) Purcell. In 1973 he married ELIZABETH "BETSY"
ANNE DALE who was born in 1951. Doug enjoys family tree research
and when Doug's uncle Col Woody Rowe Purcell died, he left his
genealogy information to Doug, who has shared information for this
book.

Children

- i Amanda Clare Purcell-b Aug 16, 1980 Columbus, Ga
- ii Christopher Douglas Purcell-b May 2, 1985
Birmingham, Al

3,370-JAMES M PURCELL/ John R/ Clare/ Mary E Callen/ Thomas A/
William III/ James/ William Callen Sr

(55B)JAMES MICHAEL PURCELL was born in 1948, the son of John R and
Lois E (Waits) Purcell. In 1974 he married JEANNIE DIANNE
ROTENBERRY who was born in 1954.

Only Child

- i Lesley Dianne Purcell-b 1981

3,371-RAY H SMITH/ Ida C Purcell/ Clare/ Mary E Callen/ Thomas A/
William III/ James/ William Callen Sr

(55B)RAY HARVISON SMITH was born in 1952, the daughter of Ida C
(Purcell) and Alexander M Smith. In 1979 she married DOUGLAS BERRY
who was born in 1952.

Children

- i Hamilton Douglas Berry-b 1984
- ii Claire Purcell Berry-b 1987

3,372-JIMMIE O ADAIR/ Gladys E Harrison/ Mary L George/ Hosia H/
James C/ Elizabeth Callen/ James/ William Callen Sr

(55F)JIMMIE ONITA ADAIR was born June 27, 1929 in Garrison New
Mexico, the daughter of Gladys E (Harrison) and Fritz A Adair. She
first married WILLIAM JOSEPH McDERMOTT JR. They were divorced, he
died April 1, 1968. Jimmie married 2nd to ROY DEAN BURROW they
divorced, Roy died August 21, 1987. Jimmie is a factory worker for

the State Highway Dept in Portales, New Mexico. She has contributed information to this book.

Children

- i Catherine Elizabeth McDermott-b Sept 30, 1947
- ii Patricia Ann McDermott-b Dec 7, 1949
- iii Linda Susan McDermott-b Oct 31, 1953
- iv William Joseph McDermott III-b July 7, 1955
- twin v James Oswald McDermott-b Apr 28, 1962
- twin vi Pamela Jo McDermott-b Apr 28, 1962
- vii Paul Gaylor Burrow-b Aug 11, 1964
- viii Patience Dean Burrow-b 1966 d 1966
- ix Patrick Lynn Burrow-b Apr 12, 1968

3,373-BILLY W SLAYTON/ Charlie W/ Henry W/ Mary F Williams/ Jamima F Choat/ Mary Callen/ James/ William Callen Sr
(55D)BILLY W SLAYTON was born on October 7, 1935 in Decatur, Texas. He is the son of Charlie W and Mary Ruth (Fortenberry) Slayton. On August 1, 1953 in Lubbock, Texas he married NORMA JEAN GARD who was born in Drumright, Oklahoma on August 9, 1933. By occupation Billy is a minister.

Children

- i Ralph Dennis Slayton-b Dec 22, 1955
- ii Londa Renee Slayton-b Sept 14, 1958
- m Mr. BRIDGES

3,374-LINDA K CALLAN/ Allie W/ Allie W/ George M II/ William D Callen/ George A/ William Jr/ William Callen Sr
(45-51B)LINDA KATHRYN CALLAN was born September 11, 1947. She is the daughter of Captain Allie W and Emily S (Hendricks) Callan. Linda married 1st in Hawaii in July of 1966 to RICHARD SHELTON. They were divorced in 1975. She married 2nd in Springfield, Virginia on June 10, 1977 to RONALD L HENDERSHOTT.

Children

- i Dana Christopher Shelton-b Dec 16, 1967
- m DESTINY WILDMAN on Jan 27, 1989
- ii Elizabeth Rebecca Shelton-b Mar 29, 1971
- iii Ronald Lee Hendershott II-b June 5, 1978
- iv Kenneth Willis Hendershott-b May 19, 1980

3,375-PATRICIA E CALLAN/ Allie W/ Allie W/ George M II/ William D Callen/ George A/ William Jr/ William Callen Sr
(45-51B)PATRICIA EVELYN CALLAN was born December 11, 1949, she is the daughter of Captain Allie W and Emily S (Hendricks) Callan. On August 3, 1968 in Montgomery, Alabama, Patricia married MICHAEL BROWN. They were divorced in 1983..

Children

- i Jennifer Suzanne Brown-b Mar 23, 1969
- ii Jeanine Evelyn Brown-b Dec 29, 1970
- iii Michelle Rhodes Brown-b Oct 30, 1974

3,376-REBECCA S CALLAN/ Allie W/ Allie W/ George M II/ William D Callen/ George A/ William Jr/ William Callen Sr
(45-51B)REBECCA SUSAN CALLAN was born October 16, 1953. In August 31, 1975 she married DONALD LARGE.

Children

- i Michael Brandon Large-b Mar 19, 1980
- ii Jessica Michelle Large-b Aug 4, 1986

3,377-JANIS L CALLAN/ Allie W/ Allie W/ George M II/ William D Callen/ George A/ William Jr/ William Callen Sr
(45-51B)JANIS LEIGH CALLAN was born October 10, 1955. On August 28, 1976 in Auburn, Alabama, she married DAVID VESTAL.

Children

- i Jamie Leigh Vestal-b June 28, 1981
- ii David McKee Vestal-b Sept 17, 1987

3,378-WILLIAM L NIGH/ Mary K Callan/ Allie W/ George M II/ William D Callen/ George A/ William Jr/ William Callen Sr
(45-51B)WILLIAM LEE NIGH was born August 19, 1951; he is the son of Mary K (Callan) and Edgar L Nigh. (51B)He graduated from the University of Ark in 1973 with a degree in electronic engineering. He received his Masters degree from the University of Md.

On April 6, 1979 William married REBECCA L BISHOP. They are now divorced; he lives in Ellicott City, Maryland.

Child

- i Lindsey Erin Nigh-b Aug 30, 1982

3,379-ROBERT L NIGH/ Mary K Callan/ Allie W/ George M II/ William D Callen/ George A/ William Jr/ William Callen Sr
(51B)ROBERT LYNN NIGH was born on July 9, 1953, the son of Mary K (Callan) and Edgar L Nigh. He graduated from the Colorado School of Mines. He is currently working on his masters degree, and is working now on defense satellites. On July 9, 1978 he married DEBORAH BRUNNER. They are living in Thornton, Colorado.

3,380-ELIZABETH A NIGH/ Mary K Callan/ Allie W/ George M II/ William D Callen/ George A/ William Jr/ William Callen Sr
(51B)ELIZABETH ANN NIGH was born April 1, 1956, the daughter of Mary K (Callan) and Edgar L Nigh. She graduated from the University of Central Arkansas with a degree in education in 1978. She is now teaching at Ballman Elementary School. On December 28, 1987 she married LILLARD CODY HAYES.

3,381-CRYSTAL COURTNEY/ Nancy A Callan/ Everett D/ George M II/
William D Callen/ George A/ William Jr/ William Callen Sr
(45-51A)CRYSTAL COURTNEY is the daughter of Everett D and Melba
(Ketten) Callan. She married DAN BUNTING.

Children

i Dan Lynn Bunting-
ii Dustan Bunting-

3,382-KAY COURTNEY/ Nancy A Callan/ Everett D/ George M II/
William D Callen/ George A/ William Jr/ William Callen Sr
(45-51A)KAY COURTNEY is the daughter of Everett D and Melba
(Ketten) Callan. She married 1st ROBBEY ROBINSON and 2nd EDDIE
BROWN.

Child

i Courtney Robinson-

3,383-JAMES C CALLEN/ Leo L/ Clinton W/ Henry D/ Socrates P/
Hannibal D/ Thomas/ William Callen Sr?

(60I)JAMES CLINTON CALLEN was born February 4, 1955 in Durant,
Oklahoma. He is the son of Leo and JoAnn (Harrison) Callen. James
married CAROLYN ANN WILLIAMSON in Milburn, Oklahoma. Carolyn was
born in Orlando, Florida on June 15, 1955 and is the daughter of
Harold Lee and Barbara (Hughes) Williamson. James is a welder,
Carolyn is a homemaker.

Children

twin i Jeremy Wade Callen-b Jan 12, 1978 Hobbs, NM
twin ii Heather Nicole Callen-b Nov 10, 1980 Denison, TX
iii Crystal Ann Callen-b Nov 10, 1980
iv Chelsea Brooke Callen-b Sept 22, 1988 Durank, OK

3,384-CHERYL A CALLEN/ Leo L/ Clinton W/ Henry D/ Socrates P/
Hannibal D/ Thomas/ William Callen Sr?

(60I)CHERYL ANN CALLEN was born November 14, 1958 (56A)in Dallas,
Texas. She is the daughter of Leo L and JoAnn (Harrison) Callen.
Cheryl married 1st JAMES ALLEN. She married 2nd to JOHN DAVID
LYMAN, JR. John was born March 20, 1948 in Everett, Washington, the
son of John D and Geneva (Montgomery) Lyman. Cheryl and John were
divorced in 1989.

Children

i Elton James Allen-b Jan 15, 1976
ii Robert Brandon Allen-b Nov 4, 1980
iii Angel Dawn Lyman-b June 8, 1987
iv Meagan Sheree Lyman-b 1988

3,385-SHARON K CALLEN/ Leo L/ Clinton W/ Henry D/ Socrates P/
Hannibal D/ Thomas/ William Callen Sr?

(60I)SHARON KAY CALLEN was born September 3, 1963 in Tishomingo,
Johnston Co, Oklahoma. She is the daughter of Leo L and JoAnn
(Harrison) Callen. Kay married 1st (60A)TRACY W DeHART. She
married 2nd to GEORGE ALPHA FORD in 1983. She is a beautician.

Children

- i Crystal Gail DeHart-b Apr 10, 1972
- ii Amanda Jo Anne DeHart-b Sept 29, 1978
- iii Cody George Ford-b Jan 12, 1984

3,386-ALAN D SULLIVAN/ Glenda Callen/ Clinton W/ Henry D/ Socrates
P/ Hannibal D/ Thomas/ William Callen Sr?

(60I)ALAN DAN "DANNY" SULLIVAN was born September 10, 1955 in
(56A) Dallas, Texas, the son of Glenda (Callen) and Dan Lucas
Sullivan. He married CINDY LOU ROHRBACHER who was born November 25,
1957, in Tiffen, Ohio, the daughter of Selden D and Earleen Y
(deJonge) Rohrbacher. Dan is a trucker.

Children

- i Amy Nicole Sullivan-b Jan 2, 1980
- ii Kara Marie Sullivan-b Feb 13, 1984

3,387-SHERRIE SULLIVAN/ Glenda Callen/ Clinton W/ Henry D/
Socrates P/ Hannibal D/ Thomas/ William Callen Sr?

(60I)SHERRIE LYNN SULLIVAN was born April 12, 1956 in Dallas,
Texas. She is the daughter of Glenda (Callen) and Dan Sullivan. She
married 1st RUSSELL OLSEN, 2nd GARY J HARKRADER who was born
February 6, 1958 in Taubebishouhum, Germany.

Children

- i Leannah Mae Olsen-b Feb 22, 1980
- ii Chase Alan Harkrader-b Jul 25, 1987

3,388-JACKIE L CALLEN/ Jackie L/ Clinton W/ Henry D/ Socrates P/
Hannibal D/ Thomas/ William Callen Sr?

(60A)JACKIE LYNN CALLEN JR was born April 21, 1958 in Ardmore,
Oklahoma. He is the son of Jackie L and Janie Faye (Dean) Callen.
On October 7, 1978 at the Callen homeplace in Milburn, OK he married
MARY ELIZABETH QUALLS. Mary was born February 11, 1960 in Sherman,
Texas, the daughter of T.L. and Pearl J (Moore) Qualls.

Children

- i Echo Deann Callen-b May 7, 1979 Denison, TX
- twin ii Jaren Lynn Callen-b Jan 9, 1985 Okla City, OK
- twin iii Sarah Beth Callen-b Jan 9, 1985

3,389-STEVEN G CALLEN/ Jackie L/ Clinton W/ Henry D/ Socrates P/
Hannibal D/ Thomas/ William Callen Sr?

(60A)STEVEN GLENN CALLEN was born September 20, 1960 in Milburn,
Oklahoma, the son of Jackie L and Janie F (Dean) Callen. On October
25, 1979 at the Callen homeplace in Milburn, OK he married PAMELA
BERNICE RHEA who was born January 27, 1963 in Fort Worth, Texas.
Pamela is the daughter of James Keith and Mary Lee (Johnson) Rhea.

Pamela died April 1986 in Milburn, Ok and is buried in the Bold
Springs Cemetery.

Children

twin 1 Stephanie Lynn Callen-b Feb 13, 1983 Clinton, OK
twin 1i Jennifer Lea Callen-b Feb 13, 1983

3,390-TERESA J CALLEN/ Jackie L/ Clinton W/ Henry D/ Socrates P/
Hannibal D/ Thomas/ William Callen Sr?

(60A)TERESA JANE CALLEN was born April 21, 1970 in California, the
son of Jackie L and Janie F (Dean) Callen. She married WALTER RAY
HUDDLESTON. They were divorced in 1988.

Only Child

1 Beth Ann Huddlestone-b Mar 11, 1988 Durant, OK

3,391-JERRY L LAWLEY JR/ Jerry L/ Theresa Callen/ Ernest L/
Socrates P/ Hannibal D/ Thomas/ William Callen Sr?

(58)"JERRY LYNN LAWLEY JR married DEBRA POWELL..."

Only Child

1 Bradley Lawley-

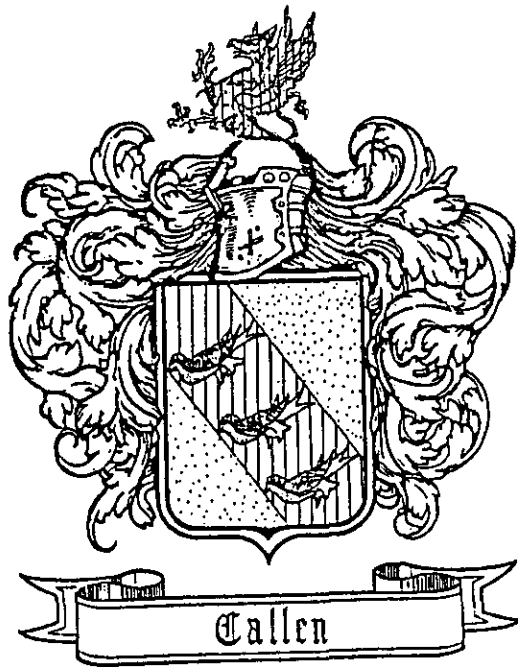

LINE OF WILLIAM CALLEN SR - 9TH GENERATION

3,392-LINDA S CRAWFORD/ Ruby M Brown/ John S/ Mary A Tinsley/ Frances A Kirkpatrick/ Samuel A/ Elizabeth Callen/ John/ William Callen Sr

(50F)LINDA SUE CRAWFORD was born December 28, 1944 in Abbeville, Louisiana. She is the daughter of Ruby (Brown) and William Crawford. On September 2, 1967 in Monroe, Ouachita Parish, Louisiana, Linda married PABLO JUAN MAX GROSS who was born June 10, 1945 in Lima Peru. "After graduation from college Linda and Pablo returned to Lima Peru. Linda lived there 8 years."

Children

- i Mariana Christina Gross-b Feb 27, 1968 La
- ii John Walter William Gross-b Feb 19, 1970 La
- iii Stacy Nicole Gross-b Dec 18, 1974 Lima Peru

3,393-WANDA PARKER/ Ruby L Bennett/ Sarah F Brown/ Mary A Tinsley/ Frances A Kirkpatrick/ Samuel A/ Elizabeth Callen/ John/ William Callen Sr

(50F)WANDA PARKER is the daughter of Ruby L (Bennett) and Wilford Parker. She married R.L. MARTIN.

Children

- i Keith Martin-
- ii Taylor Martin-
- iii Wilford Martin- m LISA MILLER

3,394-GORDON WILLIAMSON/ Douglas L/ George L/ Sarah C Tinsley/ Frances Kirkpatrick/ Samuel A/ Elizabeth Callen/ John/ William Callen Sr

(49)GORDON WILLIAMSON was born November 15 1941, the son of Douglas L and Tressie (Munday) Williamson. He married MAVIS CAROL COOLEY. "Gordon is an accountant."

Children

- i Kevin Wayne Williamson-b Sept 25, 1967
- ii Brent Lane Williamson-b May 30, 1970

3,395-RANDALL L NELSON/ Doris Williamson/ Rufus S/ Sarah Tinsley/ Frances Kirkpatrick/ Samuel A/ Elizabeth Callen/ John/ William Callen Sr

(50A)RANDALL LLOYD NELSON was born January 27, 1950 in Beaumont, Texas. On August 20, 1988, in Houston, Texas he married ELIZABETH ANN WILLOUGHBY. She was born October 17, 1958 in Missouri, daughter of Donald and Marian Willoughby.

Randy has a B.S. degree in Engineering from Vanderbilt University and is a management consultant with Ernst & Young. He has CDP and CSP certifications and is a member of the Lewis Society, Engineering Alumni Council of Vanderbilt, American Petroleum Institute, and the Houston Club. He is a member of St John's Episcopal Church.

3,396-DAVID W NELSON/ Doris Williamson/ Rufus S/ Sarah Tinsley/
Frances Kirkpatrick/ Samuel A/ Elizabeth Callen/ John/ William
Callen Sr

(50A)DAVID WILLIAM NELSON was born April 10, 1952 in Beaumont,
Texas. On November 23, 1983 in Houston, Texas he married CATHY SUE
McCLURE, she was born October 5, 1957 in Oklahoma. Cathy has a
daughter Carlesa McClure.

David attended Texas University and is a graduate of Elkins
Institute and Austin Community College. He is an electronics
engineer employed by the McDonald Observatory in the Research and
Development Department located on the University of Texas campus in
Austin.

Child

i Tracy Evelyn Nelson-b May 11, 1984 Austin, Texas

3,397-SHERRY LAUVE/ Lillie F Williamson/ Rufus Sr/ Sarah Tinsley/
Frances Kirkpatrick/ Samuel A/ Elizabeth Callen/ John/ William
Callen Sr

(50A-49)SHERRY LAUVE was born on October 8, 1949, the daughter of
Donald B and L Francis (Williamson) Lauve. She married STEVE TAYLOR
on June 7, 1969 in Houston, Texas. Sherry has a B.S. degree in
Nursing from Houston Baptist College.

Children

i Matthew Sean Taylor-b Oct 19, 1973
ii Jason Scott Taylor-b Nov 26, 1974
iii Shellee Kathleen Taylor-b Sept 16, 1977
iv Stacy Elizabeth Taylor-b Mar 20, 1979

3,398-BEVERLY L LAUVE/ Lillie F Williamson/ Rufus Sr/ Sarah
Tinsley/ Frances Kirkpatrick/ Samuel A/ Elizabeth Callen/ John/
William Callen Sr

(50A-49)BEVERLY LOUISE LAUVE was born June 29, 1956, she is the
daughter of Donald B and Francis (Williamson) Lauve. She married
DAVID TREMONT in Houston, Texas on August 27, 1977. Beverly has an
associate degree in Sociology and formerly was an accounting
assistant for Tenneco. She is presently a housewife and cub scout
leader. They have a new baby.

Children

(All born in Houston, Texas)
i Brian Michael Tremont-b July 28, 1981
ii Chad Christopher Tremont-b Dec 4, 1984
iii Sarah Celeste Tremont-b Feb 27, 1990

3,399-ELIZABETH M WALTERS/ Joseph F/ Ethel C Murphree/ Willie C Purcell/ Mary E Callen/ Thomas A/ William III/ James/ William Callen Sr

(55B)ELIZABETH MURPHREE WALTERS was born in 1957, the daughter of Joseph F and Alice (Berry) Walters. In 1979 she married RAYMOND PAUL HUDSON who was born in 1957.

Children

- i William Raymond Hudson II-b 1981
- ii Amy Elizabeth Hudson-b 1984

3,400-ELLEN C WALTERS/ Joseph F/ Ethel C Murphree/ Willie C Purcell/ Mary E Callen/ Thomas A/ William III/ James/ William Callen Sr

(55B)ELLEN CLAIRE WALTERS was born in 1959, the 2nd child of Joseph F and Alice (Berry) Walters. In 1978 she married STEVEN ROY SANDERS who was born in 1954.

Only Child

- i Steven Layton Sanders-b 1983

3,401-BARBARA G EZELL/ Mary G Walters/ Ethel C Murphree/ Willie C Purcell/ Mary E Callen/ Thomas A/ William III/ James/ William Callen Sr

(55B)BARBARA GENE EZELL was born in 1952, the daughter of Mary G (Walters) and Robert E Ezell. In 1974 she married CHARLES PAUL BUTLER III who was born in 1952.

Children

- i Amanda Claire Butler-b 1975
- ii Callen Elizabeth Butler-b 1978

3,402-NORMA J EZELL/ Mary G Walters/ Ethel C Murphree/ Willie C Purcell/ Mary E Callen/ Thomas A/ William III/ James/ William Callen Sr

(55B)NORMA JO EZELL was the 2nd daughter of Mary G (Walters) and Robert E Ezell. In 1978 she married HIRAM RAY JORDAN who was born in 1952.

Children

- i Caroline Denise Jordan-b 1980
- ii Christopher Brent Jordan-b 1984

3,403-TERRENCE C STEVENS/ Carol A Purcell/ William W R/ Clare/ Mary E Callen/ Thomas A/ William III/ James/ William Callen Sr

(55B)TERRENCE CLARE STEVENS was born September 22, 1971 in Cleveland, Ohio, the son of Carol (Purcell) and Timothy E Stevens. Terry is currently attending the University of Illinois, studying English and Russian. He is competing on the Illini Varsity Foil Fencing Team.

3,404-GWEN R STEVENS/ Carol A Purcell/ William W R/ Clare/ Mary
E Callen/ Thomas A/ William III/ James/ William Callen Sr
(55B)GWEN RANKIN STEVENS was born October 20, 1973 in Cleveland,
Ohio, she is the daughter of Carol (Purcell) and Timothy E Stevens.
Gwen is in her 5th year of competition with the Bible Quiz Team
through membership in the First Assembly of God church in Akron,
Ohio.

3,405-STACY J PURCELL/ William W R Jr/ William W R Sr/ Clare/ Mary
E Callen/ Thomas A/ William III/ James/ William Callen Sr
(55B)STACY JUNE PURCELL was born June 28, 1968. On December 16,
1989 she married DON CARL TARDY. Her bridal picture is in the
background of the picture of the Stevens' family (see 3,366).

CHARLES CALLEN

We're unsure at this time if this line is related to the other Callen lines in this book. To date we've found no connections or contacts between any of Charles' families with the other lines. However Charles Callen's name is first found in Pennsylvania in York County in 1783.

Tradition handed down from this line says, "There were 3 brothers came from Donegal, Ireland. Their name was O'CALLEN. One went away with the Indians; nothing is known about the second brother;" Charles is the third brother. Here is his family.

4,1-CHARLES CALLEN is first heard of in a deed in York Co, Pennsylvania in 1783. (62)Charles and his wife ALICE (COWGILL) Callen received money from the will of her father Henry Cowgill and his wife Alice (Payne) Cowgill. Charles and Alice apparently went to Virginia because census records show their son Henry Callen was born in Virginia in 1786.

(64A)Charles and Alice appear to have gone to Jefferson Co or Knox Co, Tennessee from Virginia since the second son was born in Tennessee in 1794 according to the 1850 census records.

Charles died on May 20, 1825; Alice died just 7 months later on December 20, 1825, both probably buried in Jefferson Co, Tennessee.

Children

(not necessarily by order of birth)

- 4,2 i Henry Callen-b Nov 30, 1786
 - 4,3 ii Archibald Callen-b ca 1794
 - 4,4 iii Mary "Polly" Callen-
 - 4,5 iv Cassandra (or Clarinda)-
 - 4,6 v Annie Callen-b Mar 22, 1797
 - 4,7 vi Charles Callen-b
 - 4,8 vii Edward Callen-b May 5, 1799
 - ? viii Elizabeth Callen- m MORGAN G MAUPINE May 30, 1822
- ? = indicates probable child - relationship not proven

(Filed in York County, Pennsylvania)

Chas Callen _____
to
Joseph Manifold

March the 22, 1783

Then and at sundry other times Received of JOSEPH MANIFOLD the sum of Twenty seven pounds six Shillings and eight pence it being money left to EAILCE CALLANS by her father HENRY COWGILL, respecting a peace of Land Will'd by HENRY COWGILL to his Daughter ELINOR, She paying to his Daughter EAILCE the Sum of Twenty five pounds I say Receivd by res

signed Charles Callen, Alice Callen

York County

Personally appeared Before me the Subscriber one of the Justices of the Peace for s. County JOHN MANIFOLD and took a Solemn Oath with an uplifted hand, and deposed and saith, That he was personally present and saw the within named CHARLES CALLEN & ALICE CALLEN, Sign with their own hand the within Receipt, And also deliver the said Receipt to the within named JOSEPH MANIFOLD, as their Act and Deed. And further saith that he the said JOHN MANIFOLD heard the said CHARLES CALLEN say divers times, That he had Received the within mentioned sum of Twenty seven Pounds six Shillings and eight pence from the within Mentioned JOSEPH MANIFOLD, this Dept further saith That he heard the said CHARLES CALLEN say divers times that he had Received from the said JOSEPH MANIFOLD his full Share of Legacy as left to him by deceased Father in Law last Will, this Depnt further saith not.

John Manifold

Sworn and Subscribed 30th Nov 1787 Before William Smith

A true Copy taken from & Compared with the Original at York the 7th day of March Anno Domini 1795

_____ - Recorder

LINE OF CHARLES CALLEN - 2ND GENERATION

4,2-HENRY CALLEN/ Charles Callen

(64A)HENRY CALLEN was born on November 30, 1786, (29)probably in Virginia, the son of Charles and Alice (Cowgill) Callen. Henry's nickname was "Diddo". On March 18, 1817 in Jefferson Co, Tennessee he married MARY ELIZABETH DOUGLAS (64C)daughter of Thomas and Kiziah Douglas. Elizabeth was born June 3, 1795. (64A)Henry brought his family by "steamboat up the Mississippi River and settled in Van Buren County, Iowa. In 1848-49 they went on to Appanoose Co. and lived in Taylor Twp."

Elizabeth died May 20, 1853, and "Diddo" died a couple weeks later on June 3 (or 7), 1853; both are buried in the Hays (Coulson) Cemetery in Appanoose Co, Iowa.

Children

- 4,9 i John Spurlock Callen-b Feb 16, 1818
- ii Eliza Ann Callen-b Nov 24, 1819 d Sept 12, 1841
- iii Perry Monroe Callen-b Feb 22, 1822 d Jan 17, 1826
- 4,10 iv Calvin Whiting Callen-b May 13, 1824
- 4,11 v Anderson Douglas Callen-b Nov 11, 1826
- 4,12 vi Emeline Delany Callen-b Oct 23, 1830
- 4,13 vii Adaline Elizabeth Callen-b Dec 3, 1833
- 4,14 viii Albert Henry Callen-b Aug 10, 1837

4,3-ARCHIBALD CALLEN/ Charles Callen

(29)"ARCHIE" CALLEN was born around 1794 in Tennessee according to the 1850 census from Iowa. (63)He married JANE EVANS on December 7, 1820, in Knox Co, Tennessee. They are listed in the 1830 census in Knox Co, Tenn, and in the 1850 census they are shown in Taylor Twp, Appanoose Co, Iowa.

Children

- i Jane Callen-b ca 1821 in Tenn
- ii Calvin? Callen-b ca 1829
- iii William E Callen-b ca 1830
- iv Sarah A.L. Callen-b ca 1833
- v Samuel H Callen-b ca 1834
- vi James P Callen-b ca 1837 in Tenn
- vii Mary A McDonnia??-b ca 1849 in Iowa

4,4-MARY CALLEN/ Charles Callen

(64A-64C)MARY "POLLY" CALLEN was the daughter of Charles and Alice (Cowgill) Callen. On October 4, 1827 she married JOHN MULVANEY, he died May 20, 1853. Polly died before the 1850 census.

4,5-CASSANDRA CALLEN/ Charles Callen

(64A-64C)CASSANDRA (or CLARINDA) CALLEN was the daughter of Charles and Alice (Cowgill) Callen. She married Mr. UNDERWOOD. Cassandra was killed when she was hit by lightning, she died July 10 (or October 7) 1850.

4,6-ANNIE CALLEN/ Charles Callen

(64A-64C)ANNIE CALLEN was born March 22, 1797, the daughter of Charles and Alice (Cowgill) Callen. She married Mr. WAKEFIELD. Annie died June 30, 1887.

4,7-CHARLES CALLEN/ Charles Callen

CHARLES CALLEN served in the (30)War of 1812 as a Private from Capt Bowman's Co in the Tennessee Militia from September 23, 1813 to December 22, 1813. He first married MARGARET INGRAM. His military records show that in 1851 and 1855 he was living in Newton Co, Missouri.

On April 3, 1856 then living in Washington Co, Arkansas Charles married 2nd SETHY BRYAN. Charles died on September 8, 1870 in Lawrence Co, Mo, his widow Sethy was living in Appanoose Co. Moravia, Iowa in 1878.

4,8-EDWARD CALLEN/ Charles Callen

(64B)EDWARD CALLEN was born on May 5, 1799 (29)in Tennessee. (63)On March 11, 1824 in Knox Co, Tenn, he married "PATSY" MARTHA CATES who was born (64B)January 15, 1800. (61)"He was of Scotch-Irish ancestry and she of German... Grandfather Callen was a large and rugged man, and lived to be about seventy years old."

(64B)Edward died December 27, 1871 (64A)and is buried in New Hope Cemetery, in Appanoose Co, Iowa. Martha died May 18, 1881.

Children

- i Martin Callen-
- 4,15 ii Pryor Lee Callen-b Sept 1827
- iii Marshall M Callen-b ca 1827
- 4,16 iv William Preston Callen-b Apr 25, 1830
- v Harriet Callen-b ca 1832 m Mr. McMURRY
- 4,17 vi Caroline Callen-b Feb 28, 1834
- vii Cordelia "Delia" Callen-b ca 1839 m Mr. ANDREWS
- viii John R Callen-b ca 1838 d May 25, 1863 age 25
during Civil War
- ix Tamsay Callen-b ca 1842 Iowa m Mr. GLADFELTER

LINE OF CHARLES CALLEN - 3RD GENERATION

4,9-JOHN S CALLEN/ Henry/ Charles Callen

(64C)JOHN SPURLOCK CALLEN was born February 16, 1818 (29)in Tennessee. He was married on September 12, 1841 to PENOLOPY MOUPINE who was born November 24, 1819. They seem to appear twice in the 1850 census for Iowa - once in the home of his parents in Appanoose Co, second in Van Co, Bonapart Twp. Perhaps they moved during the census year, (it seems unlikely that there were two men named John Callen each with a wife named Penelope, a 6 year old daughter named Elizabeth, and a 1 year old son).

Children

- i Elizabeth Ann Callen-b ca 1844
 - ii Perry Monroe Callen- buried Busby Cem Newtown, Mo
 - iii Anderson E(Emmet?) Callen-b ca 1849
 - iv Na? (female) Callen-b ca 1855
 - v Albert Callen-b ca 1861
 - vi Christine Callen-b ca 1863
 - vii George C Callen-b ca 1867
- (29)Grandson - CHARLEY BAGLEY-b 1879/1880 in Iowa

4,10-CALVIN W CALLEN/ Henry/ Charles Callen

(64C)CALVIN WHITING CALLEN was born May 13, 1824 the son of Henry and Mary Elizabeth (Douglas) Callen. He married ELIZABETH ADELINE MOUPINE who was born June 3, around 1824. Calvin died July 8, 1893 and is buried in the Busby Cemetery near Lucerne Mo.

Children

(not necessarily in order of birth)

- i William "Bill" L Callen-b ca 1847
- 4,18 ii Samuel Henry Callen-b Apr 25, 1849
- iii Sarah Callen-b Feb 26, 1857 d Apr 19, 1936
buried in Busby Cemetery
- 4,19 iv Andrew "Andy" Callen-b Jan 1858
- v Charlie Callen
- 4,20 vi Benjamin "Ben" Albert Callen-b July 9, 1864
- vii Mary Callen- d July 4, 1911
- viii Josephine Callen-b m ZAYRE COTCHEL buried Busby Cem
- ix George Callen-b d Dec 1925 m SUDIE COOKSEY

4,11-ANDERSON D CALLEN/ Henry/ Charles Callen

(64A)ANDERSON DOUGLAS CALLEN was born November 11, 1826 in Tennessee, the son of Henry and Mary Elizabeth (Douglas) Callen. In religion he was a Methodist. On July 21, 1854 he married MARY JANE CHAMBERS who was the daughter of John and Nancy (Norris) Chambers. Mary Jane was born June 21, 1835 in Vermillion Co, Indiana.

Mary Jane died July 15, 1880 just two months after the birth of their youngest daughter. Anderson died on February 24, 1905; both are buried in the Briant Cemetery, Appanoose Co, Iowa.

Children

- 4,21 i John Andrew Callen-b Oct 27, 1855
- 4,22 ii William Henry Callen-b Dec 4, 1857
- 4,23 iii Christopher Sylvester Callen-b July 29, 1861
- 4,24 iv Albert Sherman Callen-b Mar 6, 1864
- 4,25 v Eliza "Lide" Ellen Callen-b Dec 13, 1866
- 4,26 vi Jonathan Edward Callen-b Feb 21, 1869
- 4,27 vii Francis Marion Callen-b Apr 22, 1871
- viii Charles Montgomery Callen-b July 28 1873 d Nov 3 1873
- 4,28 ix Mary Lemantine Callen-b May 10, 1880

4,12-EMELINE D CALLEN/ Henry/ Charles Callen

(64A)EMELINE DELANY CALLEN was born October 23, 1830, the daughter of Henry and Mary E (Douglas) Callen. She married WILLIAM J BRIANT on December 5, 1852. Emeline died June 23, 1912.

4,13-ADALINE E CALLEN/ Henry/ Charles Callen

(64A)ADALINE ELIZABETH CALLEN was born December 3, 1833, the daughter of Henry and Mary E (Douglas) Callen. She married WILLIAM J CHAMBERS on April 31, 1857. Adaline died March 25, 1918 in Exeter, Fillmore Co, Nebraska.

4,14-ALBERT H CALLEN/ Henry/ Charles Callen

(64A)ALBERT HENRY CALLEN was born August 10, 1837. He was a soldier of the Civil War. He enlisted (64E)June 25, 1861 - Re-enlisted and re-mustered May, 1864. (64A)He was killed May 15, 1864 just after re-enlisting in the Civil War in Co. D - 6th Iowa Volunteer Infantry in Resaca Georgia. He is buried in the National Cemetery in Chattanooga, Tennessee (64E)Section L, Grave #293.

4,15-PRYOR L CALLEN/ Edward/ Charles Callen

PRYOR LEE CALLEN, (61)"was born in eastern Tennessee in September, 1827, and in 1853 came from that state to Appanoose County, Iowa, where in 1855 he was married to Miss LEMENTINE AMERICA HAYS, who was born near Nashville, Tennessee in 1833. Pryor L Callen was a pioneer farmer of this part of Iowa, taking up eighty acres of land, and is now the owner of two hundred acres, although he lives in Des Moines."

Children

- 4,29 i Harvey J Callen-b Mar 19, 1856
- ii Preston Alex Callen-
- iii Edward R Callen-b ca 1859
- iv Louella J Callen-b ca 1862 m J.B. KENYON one son
- v John A Logan Callen-b ca 1867
- vi Frank Hays Callen-b ca 1869
- vii Myrtle Callen-"died at the age of three"
- viii George P Callen-b ca 1874
- ix Laura A (Lora?) Callen-b ca 1877 m Mr. SPURGEON

4,16-WILLIAM P CALLEN/ Edward/ Charles Callen

(64B)WILLIAM PRESTON CALLEN was born on April 25, 1830. By occupation he was a farmer. He married MARY ELLEN ARMSTRONG who was born on August 31, 1838. "Preston" died on January 27, 1894; Mary died February 22, 1904, both are buried in New Hope outside of Moravia, Appanoose Co, Iowa.

Children

- 4,30 i Ira Clayton Callen-b ca 1861
ii James Polk Callen
iii Riley Seigh Callen-b ca 1863
iv Joseph Edward Callen-b ca 1865
v Martha Jane Callen-b ca 1868
vi William Callen-b ca 1870 must have died young
vii Etta May Callen-b ca 1872
4,31 viii Irwin Samuel Callen-b July 24, 1874

4,17-CAROLINE CALLEN/ Edward/ Charles Callen

(64B)CAROLINE CALLEN was born February 28, 1834, the daughter of Edward and Patsy (Cates) Callen. She married SAMUEL A HAYS on September 9, 1858. Caroline died October 30, 1919 and is buried in Old Cemetery, Moravia, Appanoose Co, Iowa.

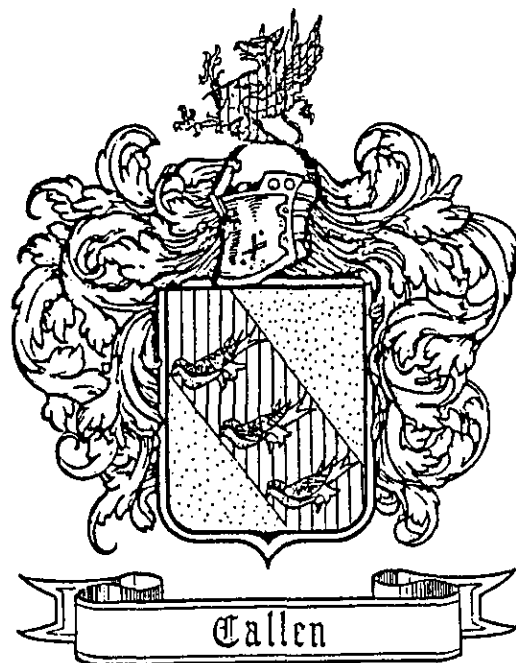

LINE OF CHARLES CALLEN - 4TH GENERATION

4,18-SAMUEL H CALLEN/ Calvin W/ Henry/ Charles Callen
(64C)SAMUEL HENRY CALLEN was born April 25, 1849 the son of Calvin and Elizabeth (Maupine) Callen. (64E)On February 19, 1882 he married CARRIE JANE LINSAY (64C)the daughter of Jacob and Jane Linsay. Carrie was born January 14, 1864.

Carrie died on November 12, 1920, and Samuel died September 18, 1932; both are buried in the Lowery Cemetery, Mercer Co, Mo.

Children

- i Rosa B Callen-b Nov 25 1882 d Dec 15 1892 Lowery Cem
- 4,32 ii Charles Emmett Callen-b July 2, 1884
- 4,33 iii Ethel Gertrude Callen-b Sept 11, 1888
- 4,34 iv Effie Callen-b Apr 18, 1892 d 1981

4,19-ANDREW CALLEN/ Calvin W/ Henry/ Charles Callen
(64C)ANDREW "ANDY" CALLEN was born January 1858, the son of Calvin W and Elizabeth A (Moupine) Callen. Andrew was a farmer. He married MARGARET EDISON. Andrew died in 1941.

Only Child

- 4,35 i Clarence Walter Callen-b Aug 19, 1889

4,20-BENJAMIN A CALLEN/ Calvin W/ Henry/ Charles Callen
(64C)"BEN" BENJAMIN ALBERT CALLEN was born July 9, 1864, in Appanoose Co. Iowa. He was the son of Calvin W and Elizabeth (Maupine) Callen. Ben was a farmer by trade. On September 5, 1888 he married HANNAH ELZADIE HILTON, Elzadi was born July 25, 1873. Ben died August 18, 1939, Elzadie died October 16, 1942; both are buried in the Ravanna Cemetery, Mercer Co, Missouri.

Children

- 4,36 i Myrtle Ida Callen-b Sept 2, 1890
- ii Alvin Emmett Callen-b July 28, 1892
- 4,37 iii Jessie Orville Callen-b June 1, 1895
- 4,38 iv Eldon Rosco Callen-b June 19, 1900
- 4,39 v Edith Grace Callen-b Sept 25, 1902
- 4,40 vi Vincil Cecil Callen-b Feb 21, 1907
- 4,41 vii Audra Gladys Callen-b Jan 24, 1911
- 4,42 viii Alma Deliel Callen-b Dec 24, 1913

4,21-JOHN ANDREW CALLEN/ Anderson D/ Henry/ Charles Callen
(64A)JOHN ANDREW CALLEN was born October 27, 1855 in Taylor Twp, Appanoose Co, Iowa. He married SUSAN JANE ARGO. John died January 1, 1933.

4,22-WILLIAM H CALLEN/ Anderson D/ Henry/ Charles Callen
(64A)"WILLIAM HENRY CALLEN was born in rural Douglas Twp, Appanoose Co, Iowa, December 4, 1857. He was the son of Anderson Douglas Callen and Mary Jane Chambers. He grew to manhood in rural

Douglas and Taylor Twps", by occupation he was a farmer. "He married MARY ISABELLE DERBY on October 3, 1880. After the marriage he probably lived in Franklin Twp., Monroe Co, Iowa. Four children were born to this union. The mother was never well after the birth of the last baby and she died in 1886," she is buried in the Derby Cemetery.

(64A-64G)William then married his second wife on March 15, 1887 in Monroe Co, Iowa. She was REBECCA PHARABY ALBERTSON who was born February 26, 1866 in Highland Twp, Hardin Co Iowa, the daughter of George J and Nancy (Jones) Albertson. William was a Methodist and Rebecca was a Quaker

Rebecca died in April 1938, William died on January 7, 1941; both are buried in the Iconium Cemetery in Appanoose Co, Iowa

Children of Mary Isabella

- 4,43 i John Norris Callen-b ca 1879
 - ii Ethel Callen- m HUGH RICHER lived in Albia, Ia
 - 4,44 iii Clara Callen- m ROSS SPEARS
- Children of Rebecca
- i Orville Loraine Callen-b Jan 4, 1889 d in Arizona
m FERN TURNER on Feb 16, 1910
 - ii Mary Isabelle "Mayme" Callen-b Aug 31, 1890
d Feb 15, 1962 unmarried
 - 4,45 iii Lawrence Elvin Callen-b Oct 14, 1894
 - 4,46 iv Lillian Merle Callen-b Oct 14, 1894
 - v Edith Pearle Callen-b Feb 1897
m EARL WOODCOCK on Oct 30, 1917 6 children
 - 4,47 vi Gilbert J "Jip" Callen-b May 15, 1899
 - 4,48 vii Viola Gertrude Callen-b July 29, 1901
 - 4,49 viii Vera Minnesota Callen-b Aug 22, 1904
 - twin ix Oran Williams Callen-b Jan 3, 1909 lived Bloomfield, Ia
m 2nd wife FLORENCE BROWN on Apr 2, 1927
 - twin x Audrey Ellen Callen-b Jan 3, 1909 d 1988
m GILBERT WOODCOCK on Dec 1928 lived in Minnesota

4,23-CHRISTOPHER S CALLEN/ Anderson D/ Henry/ Charles Callen
(64A-64G)CHRISTOPHER SYLVESTER "VET" CALLEN was born on July 29, 1861 in Taylor Twp, Appanoose Co, Iowa. He was married on August 29, 1886 to MARY MARGARET COULSON. They had 4 daughters.

4,24-ALBERT S CALLEN/ Anderson D/ Henry/ Charles Callen
(64A-64G)ALBERT "SHERMAN" CALLEN was born on March 6, 1864 in Taylor Twp, Appanoose Co, Iowa. On October 8, 1889 he married ASENATH ANN ALBERTSON. They had 1 son, Fred; and 4 daughters.

4,25-ELIZA ELLEN CALLEN/ Anderson D/ Henry/ Charles Callen
(64A-64G)ELIZA ELLEN CALLEN called "Lide" was born December 13, 1866 in Douglas Twp, Appanoose Co, Iowa. She married SAMUEL LEVI COULSEN.

4,26-JONATHAN E CALLEN/ Anderson D/ Henry/ Charles Callen
(64A-64G)JONATHAN EDWARD CALLEN was born February 21, 1869 in Douglas Twp, Appanoose Co, Iowa. (64G)He was a carpenter in the mines in Iowa. On May 29, 1893 he married CYNTHIA C BROWN who was born on November 7, 1872. Jonathan died February 15, 1937, Cynthia died April 11, 1962 and is buried in Moravia, Iowa.

Children

- i Zellman Clay Callen-b Feb 23, 1896
- ii George Leslie Callen-b May 27, 1898
- iii Elsie Mae Callen-b Feb 9, 1904
- 4,50 iv John Leroy Callen-b March 8, 1906
- v Osa Gay Callen-b Feb 17, 1910

4,27-FRANCIS M CALLEN/ Anderson D/ Henry/ Charles Callen
(64A-64G)FRANCIS MARION CALLEN was born April 22, 1871 in Douglas Twp, Appanoose Co, Iowa. He married LILLIAN MYRA HOWRY on March 28, 1893. Francis died January 1, 1943.

4,28-MARY L CALLEN/ Anderson D/ Henry/ Charles Callen
(64A-64G)MARY LEMANTINE CALLEN was born May 10, 1880 in Douglas Twp, Appanoose Co, Iowa. Her mother died when Mary was just 2 months old. Mary married on January 29, 1916 to CHARLES STONE ROCK. She died on April 5, 1964 in McCool Jct, Nebraska.

4,29-HARVEY J CALLEN/ Pryor L/ Edward/ Charles Callen
(61)"HARVEY J CALLEN, one of the prominent grain dealers of Southeastern Nebraska, has been in business in South Auburn, Nemaha county, for a number of years, and is one of the well known citizens of that place. Besides being concerned in many of the business interests of the town, he has taken a due part in social, political and religious activities, and is in all things a public-spirited citizen who may be depended upon for influence and aid in promoting the progress and development of his town and community...

"Harvey J Callen was born in Appanoose County, Iowa, March 19, 1856. Being the oldest of the family he had to work from an early age, although he obtained good schooling in the public schools. He left home, farm, and Iowa in 1879 and came to Hamilton Co, Nebraska, where for two years he was engaged in the farm implement business at Aurora. He later came to South Auburn, and the firm of H.J. Callen and Company has two elevators in this city and is doing an extensive business in handling grain... Mr. Callen is also a stockholder in the new fine brick hotel, called Avenue Hotel, in Auburn, and besides his own comfortable home on Maxwell Street owns considerable other city property.

"On Christmas day of 1880 Mr. Callen married Miss ELLEN HIATT, who was one of his schoolmates in Iowa, and is a daughter of Oren A Hiatt ... Mr. Callen affiliates with the Ancient Order of United Workmen and the Modern Woodmen, and is a member of the Methodist Episcopal church, of which he has been trustee for nine years. He

votes the Republican ticket, but has never aspired to office. He is a good citizen, and he and his family are held in the highest esteem wherever known."

Children

- i Irene Glen Callen- "died at the age of nine years"
- ii Ernest Ray Callen- "died at the age of eighteen"
- iii Fay Callen- "a girl of thirteen"

4,30-IRA C CALLEN/ William P/ Edward/ Charles Callen

(64B)IRA CLAYTON CALLEN was born in Moravia, Iowa on August 9, 1860. On March 20, 1884 in Moravia, he married MARTHA ANNABELLE (Unknown) who was born July 16, 1861. He was a farmer. Ira died on September 9, 1943, Martha died December 21, 1935, both are buried in Moravia, Iowa.

Children

- 4,51 twin i James Riley Callen-b May 13, 1885
- twin ii Mina Ree Callen-b Nov 15, 1887 m Mr. DOWD
- twin iii Inabee Callen-b Nov 15, 1887 m Mr. MILLER
- iv Hazel Gladys Callen-b July 9, 1901 m Mr. MILLER

4,31-IRWIN S CALLEN/ William P/ Edward/ Charles Callen

(64B)IRWIN SAMUEL CALLEN was born July 24, 1874 in Moravia, Iowa. By occupation he was a farmer. He married IRENA MAE DODD, who was born April 3, 1887. Irwin died May 3, 1952, Irena died February 16, 1961; both are buried in Julesburg, Colorado.

Children

(not necessarily by order of birth)

- i Aletha Merle Callen-
- ii Ivan Lanard Callen-
- 4,52 iii Creath Harold Callen-b Oct 5, 1906
- iv Lloyd Frank Callen-
- v Carl William Callen-

LINE OF CHARLES CALLEN - 5TH GENERATION

4,32-CHARLES E CALLEN/ Samuel H/ Calvin W/ Henry/ Charles Callen
(64E)CHARLES EMMETT CALLEN III was born July 2, 1884. On June 15,
1942 he married VERGIE LOIS PUTMAN, they were married in Unionville,
Missouri. Charles died April 28, 1964 and is buried in the Ravanna
Cemetery in Mercer, Co, Mo. Vergie is living in Gladstone, Mo.

Children

4,53 i Charles Douglas Callen-b Feb 11, 1943

4,33-ETHEL G CALLEN/ Samuel H/ Calvin W/ Henry/ Charles Callen
(64C-64E)ETHEL GERTRUDE CALLEN was born on September 11, 1888. On
August 1, 1907 she married CARL SEDRICK SUMMERS, the marriage being
performed by Dave Collins. Ethel died on October 7, 1984 and is
buried in Lowery Cemetery, Mercer Co, Mo.

Children

i Marion Summers-
ii J.H. Summers-
iii William "Bill" Summers-
iv Opal Summers- married Mr. BALDWIN
v Ethel Lee Summers-
vi Kenneth Summers-

4,34-EFFIE CALLEN/ Samuel H/ Calvin W/ Henry/ Charles Callen
(64C-64E)EFFIE CALLEN was born April 18, 1892. In April 190_ she
married RAY WATTENBARGER who was born in 1888. Ray died in 1940,
Effie died in 1981,

Children

i Marie Wattenbarger- m Mr. BLANCHARD
ii Earl Wattenbarger-
iii Murl Wattenbarger- living in Unionville, Mo
iv Lee Wattenbarger-
v Leona Wattenbarger-
vi Jean Wattenbarger-

4,35-CLARENCE W CALLEN/ Andrew/ Calvin W/ Henry/ Charles Callen
(64C)CLARENCE WALTER CALLEN was born August 14, 1889 in Ravanna,
Missouri. On January 1, 1911 he married MARY CLARINDA FOSTER who
was born March 17, 1895. Clarence died May 15, 1951 and is buried
in Farley Cemetery.

Children

4,54 i Velma Vernice Callen-b Sept 6, 1912
4,55 ii Harold Wesley Callen-b Oct 15, 1913
4,56 iii Richard Eppler Callen-b Dec 1, 1915
4,57 iv Ernest Olen Callen-b Jan 17, 1918

4,36-MYRTLE I CALLEN/ Benjamin A/ Calvin W/ Henry/ Charles Callen
(64C)MYRTLE IDA CALLEN was born September 2, 1890 in Mercer Co,
Missouri. She was the daughter of Benjamin A and Elzadie (Hilton)
Callen. On March 17, 190_, in Ravanna Missouri, Myrtle married
ROBERT DRAPER. Robert was born September 14, 1885 in Powerville,
Putman Co, Mo. Robert died March 16, 1957, Myrtle died January 23,
1961; they are both buried in Forsyth, Montana.

Children

- i Raleigh Edward Draper-b Nov 4, 1907
- ii Leonard Draper-b Jan 5, 1911
- iii Eula Ruth Draper-b Aug 12, 1913
- iv Willard Shelby Draper-b Feb 27, 1915

4,37-JESSIE O CALLEN/ Benjamin A/ Calvin W/ Henry/ Charles Callen
(64C)JESSIE ORVILLE (or ORVIL) CALLEN was born June 1, 1895 in
Mercer Co, Missouri. He married ORPHA ELLIOTT who was born October
14, 1899. Jessie died October 28, 1961 and is buried in Ravanna
Cemetery, Mercer Co, Missouri. Orpha died June 20, 1973 and is
buried in Basie Idaho.

Children

- i Mildred Olita Callen-b June 2, 1920
- ii Carrol Wayne Callen-b Mar 1, 1928

4,38-ELDON R CALLEN/ Benjamin A/ Calvin W/ Henry/ Charles Callen
(64C-64E)ELDON ROSCO CALLEN was born in Mercer Co, Missouri on
June 19, 1900, he was the son of Ben and Elzadi (Hilton) Callen.
Eldon was a farmer as were his father and grandfather. On April 7,
1924 in Princeton, Missouri he married NANCY EVALINE SHEPARD, Nancy
was born in Wayne Co, Iowa on April 16, 1905. Eldon died in Colony,
Kansas December 13, 1932, Nancy died December 20, 1982; both are
buried in Ravanna, Missouri

Children

- 4,58 i Clifford Windell Callen-b June 16, 1925
- ii Cleo Earline Callen- Feb 22, 1929
- iii Violeta Flow Callen-b Sept 13, 1932

4,39-EDITH G CALLEN/ Benjamin A/ Calvin W/ Henry/ Charles Callen
(64C)EDITH GRACE CALLEN was born September 25, 1902, she was the
daughter of Ben and Elzadie (Hilton) Callen. On June 7, 1924 she
married LEE WIDNER. Edith died July 9, 1937 and is buried in
Ravanna Cemetery, Mercer Co, Missouri. There were no children by
this marriage.

4,40-VINCIL C CALLEN/ Benjamin A/ Calvin W/ Henry/ Charles Callen
(64C)VINCIL CECIL CALLEN was born on February 21, 1907 in Mercer,
Mo. He was the son of Ben and Elzadi (Hilton) Callen. Vincil was a
farmer and a real estate salesman. On December 23, 1925 in
Princeton Mo, he married MARY OPAL SHEPHERD. Opal was born July 10,
1906 in Powersville, Mo. Vincil died February 9, 1974 of a stroke

just 12 days before his 67th birthday. Opal is living in Trenton, Mo, she has contributed information to this book.

Children

- 4,59 i Betty Jean Callen-b Mar 6, 1927
- 4,60 ii Kenneth Lee Callen-b Feb 2, 1929
- 4,61 iii Donald Duane Callen-b Jan 26, 1932

4,41-AUDRA G CALLEN/ Benjamin A/ Calvin W/ Henry/ Charles Callen
(64C)AUDRA GLADYS CALLEN was born January 24, 1911. On October 6, 1928 she married LOREN WIDNER who was born February 4, 1903. Loren died June 14, 1986 and is buried in Ravanna Cemetery, Mercer Co, Missouri. Audra is living in Ravanna Co.

Children

- i Earl Dean Widner-b Nov 28, 1929 d Nov 29, 1929
- twin ii Wava Alene Widner-b Jan 24, 1931 d Feb 4, 1931
- twin iii Wanda Lorene Widner-b Jan 24, 1931 d Feb 3, 1931
- iv Peggy Louise Widner-b July 6, 1933
- v Shelby Gene Widner-b June 4, 1941
- vi Janice Sue Widner-b Dec 31, 1944

4,42-ALMA D CALLEN/ Benjamin A/ Calvin W/ Henry/ Charles Callen
(64C)ALMA DELIEL CALLEN was born December 24, 1913, the daughter of Ben and Elzadie (Hilton) Callen. In May 1932 she married FRED HOLMES who was born February 22, 1909. Fred died February 22, 1973 in Melbourne, Florida, he is buried in Forsyth, Montana. Alma married 2nd to TED CUNNINGHAM.

Children

- i Earnest Winton Holmes-b Dec 1, 1932
- ii Janet June Holmes-b Jul 18, 1937
- iii Billy Dean Holmes-b Mar 1, 1945

4,43-JOHN N CALLEN/ William H/ Anderson D/ Henry/ Charles Callen
(64G)JOHN NORRIS CALLEN was born July 1881 in Iconium, Iowa. He was a farmer by trade. On May 16, 1904 in Albia, Iowa he married EVA JANE McCABE who was born November 12, 1884 in Red Oak, Iowa. Eva had been married before to Jesse Derby.

John died in September 1963, Eva died on May 21, 1977; both are buried in Iconium, Iowa.

Children

- S/D Lura May Derby-b June 3, 1901 m Mr. HALTON
- 4,62 i Clyde Francis Callen-b Aug 13, 1904
- 4,63 ii Lloyd Leonard Callen-b Nov 12, 1906
- iii Orris James Callen-b- ca 1910 d Feb 1926
died at age 16 "thrown from a horse (his father had just bought) onto the frozen ground"
- 4,64 iv Marvin Hubert Callen-b May 11, 1924

4,44-CLARA CALLEN/ William H/ Anderson D/ Henry/ Charles Callen
(64G)CLARA CALLEN was the daughter of William H Callen and his first wife Mary I Derby. Ethel married ROSS SPEARS and they lived in Albia, Iowa.

Only Child

i Harry Spears-

4,45-LAWRENCE E CALLEN/ William H/ Anderson D/ Henry/ Charles Callen

(64G)LAWRENCE ELVIN CALLEN was born October 14, 1894, the son of William H and Rebecca P (Albertson) Callen. He married ARTIE CLINE and they lived in Wyoming. Lawrence "was killed by lighting very early in life." They had 2 children.

4,46-LILLIAN M CALLEN/ William H/ Anderson D/ Henry/ Charles Callen

(64G)LILLIAN "MERLE" CALLEN was born October 14, 1894, the daughter of William H and Rebecca (Albertson) Callen. She married RALPH CLINE and lived in Wyoming. Merle died on April 5, 1984 in Cheyene, Wyoming. They had several children

4,47-GILBERT J CALLEN/ William H/ Anderson D/ Henry/ Charles Callen
(64A-64G)GILBERT J "JIP" CALLEN was born May 15, 1899, the son of William H and Rebecca (Albertson) Callen. He married EDITH TOWNSEND. Jip died on June 11, 1966.

Children

- i Richard Callen-
- ii Virginia Callen-
- iii Crystal Callen-
- iv Doris Callen-
- v

4,48-VIOLA G CALLEN/ William H/ Anderson D/ Henry/ Charles Callen
(64A)VIOLA GERTRUDE CALLEN was born July 29, 1901 in Appanoose Co, Iowa. On June 2, 1920 she married LLOYD HUBERT CLARK who was born March 7, 1899 in Monroe Co, Iowa. Lloyd died on December 28, 1986 and is buried in Colorado Junction, Iowa.

Children

- 4,65 i Dorothy Frances Clark-b Apr 19, 1921
- + 5 other children

4,49-VERA M CALLEN/ William H/ Anderson D/ Henry/ Charles Callen
(64G)VERA MINNESOTA CALLEN was born August 22, 1904, the daughter of William H and Rebecca P (Albertson) Callen. She married ELBERT MOORE, they "lived on a farm near Melrose, Iowa." They were the parents of 4 children.

4,50-JOHN L CALLEN/ Jonathan E/ Anderson D/ Henry/ Charles Callen
(64H)JOHN LEROY CALLEN was born March 8, 1906 in Iowa, he was the son of Jonathan E and Cynthia (Brown) Callen. John was a teacher, and "coached a girls basketball team 'way back'". He married WILMA OLIVE WHISLER on April 2, 1927. Wilma was born on February 15, 1906, and she was also a teacher. John died in Moravia, Iowa on November 8, 1958.

Children

i Wilma Joyce Callen-b Oct 3, 1932
4,66 ii Janet Marie Callen-b Mar 13, 1943
4,67 iii John Michael Callen-b Oct 16, 1946

4,51-JAMES R CALLEN/ Ira C/ William P/ Edward/ Charles Callen
(64B)JAMES RILEY CALLEN was born on May 13, 1885 in Moravia, Iowa. He was the son of Ira C and Martha A Callen. On February 22, 1908 in Centerville, Iowa, he married FANNIE BLISS GLICK who was born in Centerville on May 5, 1885. James was a farmer like his father and grandfather. James died on February 7, 1948, Fannie died on March 13, 1973, both are buried in Moravia, Iowa.

Children

i Edrie Garnet Callen-b Jan 20, 1909 m Mr. PHILLIPS
ii Reba Marivee Callen-b Dec 14, 1913 m Mr. PACKARD
iii Ardis Hope Callen-b Nov 6, 1915 m Mr. WALTER
iv Virgie Glee Callen-b Nov 20, 1917 m Mr. DAYTON
4,68 v Dale Randall Callen-b Apr 11, 1925

4,52-CREATH H CALLEN/ Irwin S/ William P/ Edward/ Charles Callen
(64B)CREATH HAROLD CALLEN was born October 5, 1906 in Moravia, Iowa. By occupation he was a Standard Oil Bulb Dealer. On March 23, 1937 he married ETHEL MARGARET WELSH who was born in St. Paul, Nebraska. Ethel is a housewife and bookkeeper. Creath died on January 3, 1955 and is buried in Ogallala, Nebraska. Ethel has married again to MR. HAYS.

Children

i Larry Lee Callen-b Dec 4, 1941
4,69 ii James Blaine Callen-b Nov 23, 1947
iii Max Harold Callen-b May 15, 1950

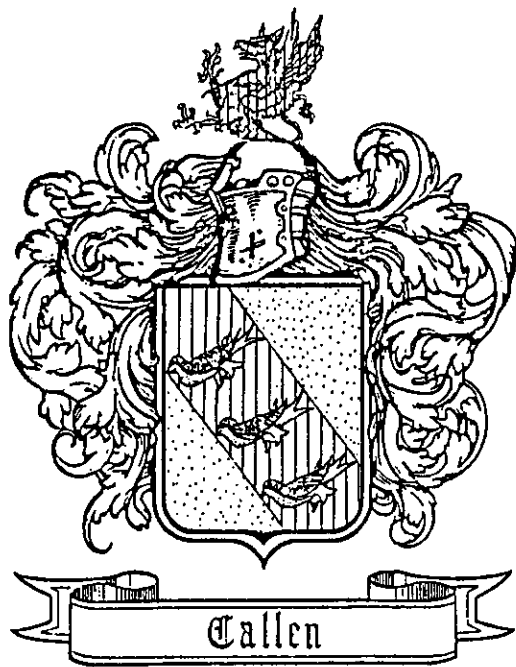

LINE OF CHARLES CALLEN - 6TH GENERATION

4,53-CHARLES D CALLEN/ Charles E/ Samuel H/ Calvin W/ Henry/ Charles Callen

(64E)CHARLES DOUGLAS CALLEN was born on February 11, 1943. On June 9, 1967 he married ALICE JANE BROWNING. They were married by Paul Smith at the Broadway Baptist Church in Kansas City, Missouri. Charles died on January 3, 1983.

Only Child

i Douglas Bradley Callen-b Jan 22, 1968

4,54-VELMA V CALLEN/ Clarence W/ Andrew/ Calvin W/ Henry/ Charles Callen

(64C)VELMA VERNICE CALLEN was born September 6, 1912 in Ravanna, Mercer, Co Missouri. She is the daughter of Clarence W and Clarinda (Foster) Callen. Velma married GEORGE PRESTON PLATTENBURG.

Only Child

i Mary Virginia Plattenburg-

4,55-HAROLD W CALLEN/ Clarence W/ Andrew/ Calvin W/ Henry/ Charles Callen

(64C)HAROLD WESLEY CALLEN was born October 15, 1913, the son of Clarence W and Clarinda (Foster) Callen. Harold married PHILLIS LEE.

Children

i Harold Eugene Callen-b Sept 3, 1937 in Princeton
ii Donnie Lee Callen-b Mar 23, 1939
iii Sandra Sue Callen-b Nov 5, 1943 Rock Island, Ill
iv Steve Callen-b Oct 23, 1948

4,56-RICHARD E CALLEN/ Clarence W/ Andrew/ Calvin W/ Henry/ Charles Callen

(64C)RICHARD EPPLER CALLEN was born December 1, 1915. He married HELEN BLACK.

Children

(all born in Princeton)

i Richard Eugene Callen-b Jan 30, 1937
ii Carol Joyce Callen-b Aug 21, 1940
iii Linda Rea Callen-b Feb 20, 1942

4,57-ERNEST O CALLEN/ Clarence W/ Andrew/ Calvin W/ Henry/ Charles Callen

(64C)ERNEST OLEN CALLEN was born January 17, 1918, the son of Clarence W and Clarinda (Foster) Callen. He married LOTTIE BURK.

Children

i Eldon Neil Callen-b Sept 3, 1938 Madena, Mo
ii Gary B Callen-b June 4, 1943 Rolla, Mo

iii Ernie Lee Callen-b June 9, 1945 Rolla, Mo
iv Ira Dave Callen-b Dec 5, 1946 Rolla, Mo

4,58-CLIFFORD W CALLEN/ Eldon R/ Benjamin A/ Calvin W/ Henry/
Charles Callen

(64I)CLIFFORD WINDELL CALLEN was born in Ravanna, Missouri on June 16, 1925, he is the son of Eldon R and Nancy (Shepard) Callen. Clifford is a farmer, truck driver, and oil company supervisor. His first wife was ANITA MAE HENLEY who was born in Mercer, Missouri on July 1, 1929, they were married in 1948. His second wife is NORMA R ESTES who was born in Flora, Illinois on August 9, 1921, they were married in Trenton, Mo on March 1, 1969. Norma is a medical supervisor.

Children

4,70 i James Windell Callen-b June 5, 1953
4,71 ii Doyle Eugene Callen-b May 29, 1955
4,72 iii Linda Mae Callen-b Mar 14, 1957

4,59-BETTY J CALLEN/ Vincil C/ Benjamin A/ Calvin W/ Henry/
Charles Callen

(64C)BETTY JEAN CALLEN was born on March 6, 1927, the daughter of Vincil and Opal (Shepherd) Callen. Betty married JUDSON LEONARD BAUGHER on May 5, 1944. Judson was born on January 19, 1921.

Children

4,73 i Carrol DeWayne Baugher-b Apr 21, 1947
4,74 ii Gary Eugene Baugher-b Dec 1, 1948

4.60-KENNETH L CALLEN/ Vincil C/ Benjamin A/ Calvin W/ Henry/
Charles Callen

(64C)KENNETH LEE CALLEN was born February 2, 1929, he is the son of Vincil and Opal (Shepherd) Callen. Kenneth married MARGARET RUBY ELLIOTT on February 24, 1959.

Children

4,75 i Kenneth Michael Callen-b Dec 14, 1951
4,76 ii Deborah Jean Callen-b Dec 13, 1953

4,61-DONALD D CALLEN/ Vincil C/ Benjamin A/ Calvin W/ Henry/
Charles Callen

(64C)DONALD DUANE CALLEN was born January 26, 1932, the 3rd child of Vincil and Opal (Shepherd) Callen. Donald married NILA JEAN STOKESBERRY on February 5, 1955. Donald died on April 21, 1988.

Children

4,77 i Scotty Duane Callen-b May 30, 1956
4,78 ii Tammie Jean Callen-b Feb 11, 1958

4,62-CLYDE F CALLEN/ John N/ William H/ Anderson D/ Henry/ Charles Callen

(64G)CLYDE FRANCIS CALLEN was born August 13, 1904. He was the son of John N and Eva (McCabe) Callen. He married first to JOSEPHINE HUEY in March 1927, they divorced and had no children. He married 2nd to HELEN OSTRING.

Only Child

i Kenneth Eugene Callen-b 1946 married JOAN

4,63-LLOYD L CALLEN/ John N/ William H/ Anderson D/ Henry/ Charles Callen

(64F)LLOYD LEONARD CALLEN was born in Melrose, Iowa on November 12, 1906. He is the son of John N and Eva (McCabe) Callen. Lloyd is a farmer as were his father and grandfather. They belong to the Church of Christ.

On June 7, 1926, in Albia, Iowa he married AUDREY BERNADINE AMMONS. Audrey was born on April 22, 1908 in Seymour, Iowa, she is the daughter of Fred D and Fern (Miller) Ammons. They are presently living in Moravia, Iowa, and Audrey has contributed information to this book.

Children

4,79 i Harold Leonard Callen-b Dec 19, 1927 or 28
4,80 ii Evelyn Bernadine Callen-b Apr 26, 1936
4,81 iii David Frederick Callen-b Aug 10, 1938
4,82 iv Eugene John Callen-b May 21, 1941

4,64-MARVIN H CALLEN/ John N/ William H/ Anderson D/ Henry/ Charles Callen

(64F)MARVIN HUBERT CALLEN was the youngest son of John N and Eva (McCabe) Callen. He was born May 11, 1924, "and yes he was a surprise" to his parents, being 14 years younger than his brother Orris. Marvin married JUDY HONSWALT. He is living in Prairy City, Iowa, and has helped supply information on his family line for our book.

4,65-DOROTHY F CLARK/ Viola G Callen/ William H/ Anderson D/ Henry/ Charles Callen

(64A)DOROTHY FRANCES CLARK was born on April 19, 1921 in Monroe County Iowa. She is the daughter of Lloyd H and Viola Gertrude (Callen) Clark. She married HOLLIS LeROY McCONAHAY on Valentines Day February 14, 1941. Dorothy is an accountant. She is also interested in her family history and has contributed her research and time for this book.

Children

i Nancy Elaine McConahay-b April 7, 1942 m Mr. FRANTZ
ii Brian Dwain McConahay-b Dec 2, 1944 d July 29, 1967

4,66-JANET M CALLEN/ John L/ Jonathan E/ Anderson D/ Henry/
Charles Callen

(64H)JANET MARIE CALLEN was born on March 12, 1943 in Racine,
Wisconsin. She is the daughter of John Leroy and Wilma (Whisler)
Callen. Janet is a secretary and is living in Minneapolis.

4,67-JOHN M CALLEN/ John L/ Jonathan E/ Anderson D/ Henry/
Charles Callen

(64H)JOHN MICHAEL CALLEN was born on October 16, 1946, the only
son of John Leroy and Wilma (Whisler) Callen. He is the only living
male descendant of Jonathan Callen to carry the Callen name.

Child

i daughter-b ca 1976

4,68-DALE R CALLEN/ James R/ Ira C/ William P/ Edward/ Charles
Callen

(64B)DALE RANDALL CALLEN was born on April 11, 1925 the son of
James Riley and Fannie (Glick) Callen. In July 1949 in Chariton,
Iowa he married EVELYN LAVONNE DelREERE who was born on September
14, 1925 in Tipperary, Iowa. Evelyn and Dale are both retired, Dale
from Firestone Tire & Rubber Co.

Children

i Craig Randall Callen-b June 12, 1952
ii Bruce Michael Callen-b Mar 25, 1953
iii Sheri Lavonne Callen-b Apr 18, 1957

4,69-JAMES B CALLEN/ Creath H/ Irwin S/ William P/ Edward/ Charles
Callen

(64B)JAMES BLAINE CALLEN was born on November 23, 1947 in
Ogallala, Nebraska. On June 27, 1970 in Grand Island, Nebraska, he
married MARY ELIZABETH VACLAVAK who was born on August 15, 1948
in Grand Island. Both James and Mary are teachers.

Children

i John Preston Callen-b Mar 18, 1977
ii Matthew Reed Callen-b Sept 1, 1983

LINE OF CHARLES CALLEN - 7TH GENERATION

4,70-JAMES W CALLEN/ Clifford W/ Eldon R/ Benjamin A/ Calvin W/
Henry/ Charles Callen

(64I)JAMES WINDELL CALLEN was born June 5, 1953, the son of
Clifford W and Anita M (Henley) Callen. James married DONNIA GRAY.

Children

- i Jason Frederic Callen-b Apr 1, 1975
- ii Jammie Gray Callen-b Apr 6, 1977

4,71-DOYLE E CALLEN/ Clifford W/ Eldon R/ Benjamin A/ Calvin W/
Henry/ Charles Callen

(64I)DOYLE EUGENE CALLEN was born May 29, 1955, the son of
Clifford W and Anita M (Henley) Callen. Doyle's first wife was
HIEDI JOHNSON.

Children

- i Benji Callen-
- S/S Robbie-
- S/D Stephenie-

4,72-LINDA M CALLEN/ Clifford W/ Eldon R/ Benjamin A/ Calvin W/
Henry/ Charles Callen

(64I)LINDA MAE CALLEN was born March 14, 1957, the daughter of
Clifford W and Anita M (Henley) Callen.

Child

- i Ashley Renee-b Aug 23, 1989

4,73-CARROL D BAUGHER/ Betty J Callen/ Vincil C/ Benjamin A/
Calvin W/ Henry/ Charles Callen

(64C)CARROL DEWAYNE BAUGHER was born April 21, 1947, the oldest
child of Betty J (Callen) and Judson L Baugher. His first wife was
MARSHA CHRISMAN. He later married KAROL PIERCE.

Children

- i Alissa Denise Baugher-b Sept 23, 1970
- ii Brent Allen Baugher-b Mar 29, 1974
- twin iii Daniel Clayton Baugher-b Nov 20, 1977
- twin iv Eric Nathan Baugher-b Nov 20, 1977

4,74-GARY E BAUGHER/ Betty J Callen/ Vincil C/ Benjamin A/ Calvin
W/ Henry/ Charles Callen

(64C)GARY EUGENE BAUGHER was born December 1, 1948, the second
child of Betty J (Callen) and Judson L Baugher.

Only Child

- i Shawn Allen Baugher-b Feb 7, 1980

4,75-KENNETH M CALLEN/ Kenneth L/ Vincil C/ Benjamin A/ Calvin W/
Henry/ Charles Callen

(64C)KENNETH MICHAEL CALLEN was born on December 14, 1951, the son
of Kenneth L and Margaret R (Elliott) Callen. Kenneth married
TAMMIE KELSELL.

Child

i Blake Michael Callen-b Feb 24, 1989

4,76-DEBORAH J CALLEN/ Kenneth L/ Vincil C/ Benjamin A/ Calvin W/
Henry/ Charles Callen

(64C)DEBORAH JEAN CALLEN was born on December 13, 1953, the
daughter of Kenneth L and Margaret R (Elliott) Callen. Deborah
married RODNEY MCGOWAN. She remarried to GREG WHITNEY.

Children

i Heather Lee McGowan-b Feb 5, 1972

ii Wesley Tyson Whitney-b July 2, 1977

4,77-SCOTTY D CALLEN/ Donald D/ Vincil C/ Benjamin A/ Calvin W/
Henry/ Charles Callen

(64C)SCOTTY DUANE CALLEN was born May 30, 1956 the son of Donald D
and Nila J (Stokesberry) Callen. In June 1987 he married NANCY
HADDAD.

Child

i Ashley Marie Callen-b Jan 13, 1989

4,78-TAMMIE J CALLEN/ Donald D/ Vincil C/ Benjamin A/ Calvin W/
Henry/ Charles Callen

(64C)TAMMIE JEAN CALLEN was born February 11, 1958, the daughter
of Donald D and Nila j (Stokesberry) Callen. She married DANNY
CAMP, and later married to MIKE MISNER.

Children

i Jacob Daniel Camp-b Oct 11, 1978

ii Mitchell Callen Misner-b Nov 9, 1985

4,79-HAROLD L CALLEN/ Lloyd L/ John N/ William H/ Anderson D/
Henry/ Charles Callen

(64G)HAROLD LEONARD CALLEN was born December 19, 1927. He is the
son of Lloyd L and Audry (Ammons) Callen. He was first married to
BETTY and second to LEE EWALT. "Harold and Lee also raised her
youngest daughter Tami Ewalt."

Child of Betty

i George Harold Callen-

3,80-EVELYN B CALLEN/ Lloyd L/ John N/ William H/ Anderson D/
Henry/ Charles Callen

(64G)EVELYN BERNADINE CALLEN was born on April 10, 1936. She is the daughter of Lloyd L and Audry (Ammons) Callen. Evelyn married EUGENE McCRARY. "Evelyn raised three other children in their home; 2 nephews and a neice - Dan, John, and Joy - grown now with families."

Children

- 4,83 i Gerry McCrary-
 ii Paul McCrary-
 iii Roger McCrary

3,81-DAVID F CALLEN/ Lloyd L/ John N/ William H/ Anderson D/
Henry/ Charles Callen

(64G)DAVID FREDERICK CALLEN was born on August 10, 1938, he is the son of Lloyd L and Audry (Ammons) Callen. David married BEVERLY HEDLREND.

Children

- i Debbie Callen- married GARY HOLLINGSWORTH
 ii Judy Callen- married SHAWN PARCEL
 iii Ron Callen- married MICHELLE
 iv Sherri Callen-

4,82-EUGENE J CALLEN/ Lloyd L/ John N/ William H/ Anderson D/
Henry/ Charles Callen

(64F)EUGENE JOHN CALLEN was born on May 21, 1941 in Melrose, Iowa. He first married NANCY MALLORY, they divorced. On June 12, 1964 in Hamilton, Illinois he remarried THELMA LOUISE BEERBOWER who was born on April 8, 1942 in Lancaster, Missouri. Eugene and Thelma own their own business, and are living in Albia, Iowa.

Child of Nancy

- i John Orval Callen- adopted by Nancy's 2nd husband
 known as John O Doty

Children of Thelma

- 4,84 i Kevin Eugene Callen-b Dec 6, 1964
4,85 ii Scott Keith Callen-b Mar 12, 1966
4,86 iii Thelma Renee Callen-b Oct 5, 1967
 iv Edwin Lloyd Callen-b Jun 23, 1969
 v Julie Lynn Callen-b Oct 3, 1971
 vi Jason Wendell Callen-b Dec 19, 1976

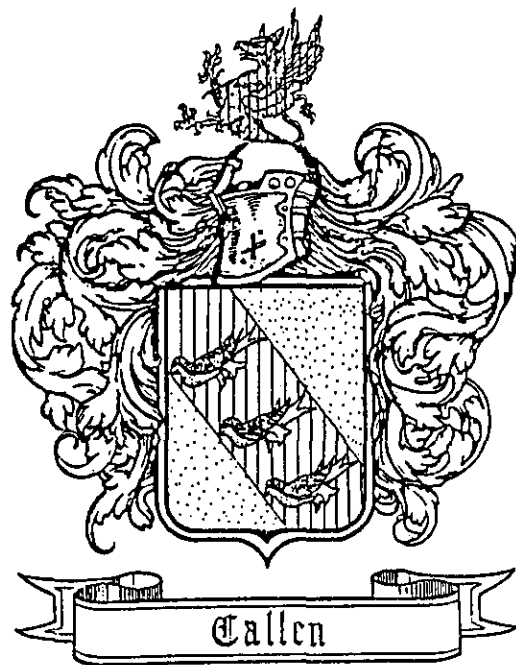

LINE OF CHARLES CALLEN - 8TH GENERATION

4,83-GERRY MCCRARY/ Evelyn B Callen/ Lloyd L/ John N/ William H/
Anderson D/ Henry/ Charles Callen
(64G)GERRY MCCRARY is the son of Evelyn B (Callen) and Eugene
McCrary. He married JENNIFER GREEN.

Children

- i Joel McCrary-
- ii Jessica McCrary-

4,84-KEVIN E CALLEN/ Eugene J/ Lloyd L/ John N/ William H/
Anderson D/ Henry/ Charles Callen
(64F)KEVIN EUGENE CALLEN was born December 6, 1964. He is the son
of Eugene J and Thelma L (Beerbower) Callen. He married JANET. He
served his country in the military for 2 years.

Children

- i Stephanie Callen-
- ii Stacy Callen-

4,85-SCOTT K CALLEN/ Eugene J/ Lloyd L/ John N/ William H/
Anderson D/ Henry/ Charles Callen
(64F)SCOTT KEITH CALLEN was born on March 12, 1966, the son of
Eugene J and Thelma L (Beerbower) Callen. He married TINA. Scott
served 3 years in Germany.

Children

- i Jeremy Callen-
- ii Jennie Jo Callen-

4,86-THELMA R CALLEN/ Eugene J/ Lloyd L/ John N/ William H/
Anderson D/ Henry/ Charles Callen
(64F)THELMA RENEE CALLEN was born October 5, 1967, the daughter of
Eugene J and Thelma L (Beerbower) Callen. She married DENNIS
TOEPFER.

Child

- i Cindy Toepfer-

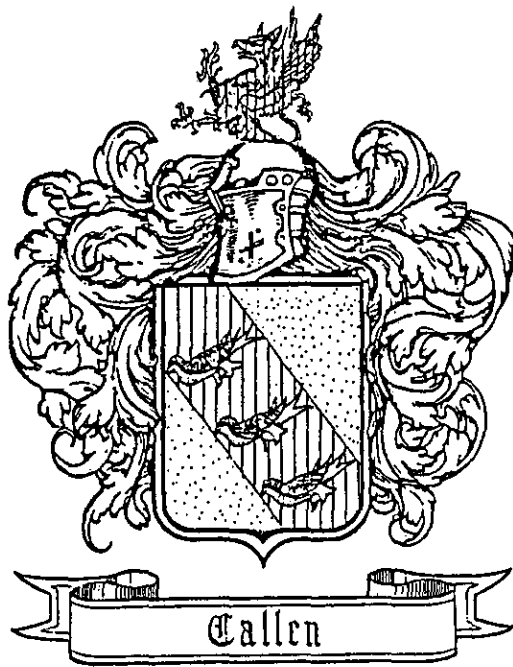

APPENDIX A

1742 -- Lancaster County deeds - B252

This Indenture made the fourth day of March in the year of our Lord One Thousand seven Hundred and forty two between JOHN CALLEN of Pennsborough Township in the County of Lancaster & province of Pennsylvania, Yeoman of the one part & RICHARD PETERS of the City of Philadelphia in the said Province Gentleman of the other part.

WITNESSETH That the said JOHN CALLEN for & in consideration of the sum of Seventy five pounds lawfull money of the said province to him in hand paid & satisfied by the said RICHARD PETERS at or before the Executing and delivery hereof the receipt whereof the said JOHN CALLEN doth hereby acknowledge --thereof & every part thereof doth acquit release & discharge the said RICHARD PETERS his Heirs Executors Administrators & assigns by these presents to the said JOHN CALLEN hath granted bargained sold aliened released and confirmed and by these presents doth grant bargain sell alien release & confirm unto the said RICHARD PETERS his Heirs Assigne All that plantation & tract of land containing Three hundred & sixty-two acres with the usual allowance of six acres percent roads situate and being in Pennsborough Township aforstd on the West Side of Susquehanna River in the sd. County of Lancaster bounded & described as follows erz:

Beginning at a marked Spanish Oak standing the side of Conedogwainet creek and from thence extending by JOHN WATT'S land South eleven degrees East twenty-four perches to a marked Hickory South fifty one Degrees West twenty two perches to a marked black oak South thirteen degrees West ninety seven perches to a marked Hickory & South seventy degrees East thirty nine perches to marked Spanish Oak thence by vacant Land South forty nine degrees West One Hundred & Twenty One perches to a marked Black Oak and South Seventy nine Degrees W Eighty seven perches to a marked Chestnut Oak thence by JAMES ARMSTRONG'S Settlement north fifteen degrees West Two Hundred & Sixty two perches to a marked red Oak standing by the said Creek thence down the same Creek on the several courses thereof about three hundred & Ninety two perches to the place of beginning

Together with all & singular the M_____ Houses? Outhouses? _____ Orchard Improvements and appurtenances whatsoever to the same belonging or in any wise appertaining, and the _____ & remainders Rents? _____ & profits thereof TO HAVE & TO HOLD the said three hundred & sixty two acres of land & premises with the Appurtenances unto the said RICHARD PETERS his Heirs & assigns to the only proper use and behoof of the said RICHARD PETERS his Heirs & assigns forever Under and subject to the yearly Quit rents from henceforth to become due for the same premises to the proprietors of the said province and their Heirs according as reserved & made payable in and by a certain patent granted by the said Proprietors to the said JOHN CALLEN for the said Premises bearing Date the third day of this instant March 1742 as by the said patent Relation? being thereunto had more fully _____ at

large appears Provided always nevertheless

and it is the true intent & meaning of these presents and of the parties hereto That if the said JOHN CALLEN his Extors Admins or Assigns or any of them do and shall well & truly pay or cause to be paid unto the said RICHARD PETERS his Heirs Executors Administrators or Assigns the said Sum of Seventy Five pounds & Interest in manner _____ following at the said City of Philadelphia.

That is to say the sum of Ninteen Pounds Ten Shillings part thereof on the fourth day of March which will be in the year of Our Lord One Thousand Seven hundred forty three;

the Sum of Eighteen Pounds _____ shillings more thereof on the fourth day of March which will be in the year of our Lord One Thousand Seven Hundred & forty four;

the sum of Seventeen Pounds fourteen Shillings more thereof on the fourth day of March which will be in the year of Our Lord One Thousand Seven Hundred and Forty five;

and the sum of Fifteen Pounds Eighteen Shillings the residue thereof on the fourth day of March which will be in the year of our Lord One Thousand Seven Hundred Forty seven

without any deduction or _____ upon account of Taxes or any other matter or thing whatsoever that then & from thence forth this present Indenture and the estate thereby granted shall cease, _____ and be void

AND the said JOHN CALLON for himself his Heirs Executors and Administrators Doth hereby covenant & grant to and with the sd. RICHARD PETERS his Heirs & assigns that if default be made in the payment of that several sume of money at the time & place aforesd of any part of them that then it shall & may be lawful to & for the sd RICHARD PETERS his Heirs and Assigns to bargain sell alien transfer & convey an absolute or indefeazible Estate of Inheritance in fee simple in the lands and tenements? above mentioned and every part or parcel thereof with the appurtenances to any person or persons who will purchase the same under the quit rent then due _____ becomes due to the proprietors afsd and out of the money arising by such sale can satisfy himself not only all & every? the principal sum and sums of money and interest which shall then be due according to the purport _____ of these presents but also all the principal sum which shall then remain unpaid deducting the interest included although the several days of payment according to the Condition aforesd be not then incurred or come? any thing herein contained to the contrary notwithstanding.

Provided also that before any such sale be made of the premises that he the sd. RICHARD PETERS, his Heirs or Assigns shall cause publick notice to be given of Such Sale by affixing on the Courthouse door of Lancaster County aforesd. at least ten days before the time of sale a Writing purporting the intended sale of the same land & premises together with the day hour & place where such Sale is to be made And if any sum or sums of money shall remain in the hands of

him the sd. RICHARD PETERS his Heirs Executors or Administrators after the payment and satisfaction of the sd. principal sum and the interest thereof Together with reasonable Allowance for his or _____ & expenses in & about the premises and for suing Prosecuting obtaining & executing the judgment herein after mentioned that then the _____ money _____ be paid to the said JOHN CALLEN his Heirs or Assigns and to the end that such purchaser or purchasers of the premises may be put into the quiet and peaceable possession thereof it is further covenanted and agreed between the sd. parties hereto that he the said JOHN CALLEN Doth by these presents authorize and impower WILLIAM PETERS or any other of the Attorneys of the Court of Common Pleas of the County of Lancaster aforesd. for the time being to appear for him the said JOHN CALLEN, his Heirs Devisees or Assigns in the Court aforesd. to be held after any Default made in the payment aforesd. or any part thereof and then and there to receive _____ a plea of Trespass _____ Ejectment for the said tenements aforesd.

There to be brought against him the said JOHN CALLEN his Heirs devisees or assigns at the _____ of the _____ of the sd. RICHARD PETERS or his assigns as the Term next after any such Default or at any Time Subsequent and to the Declaration so to be received to _____ or _____ Judgment to be ordered against him the said John Callen his Heirs Devisees or Assigns by _____

AND the sd. John Callen for himself his Heirs Extors & Adnon Doth hereby promise _____ & forever Quit Claim unto the sd RICHARD PETERS his Exectors Admons & Assigns _____ or any of them all & all manner of errors and Error Mis_____, Misentries Defects & Imperfections whatsoever in the _____ of the said Judgment or any _____ or processing thereon or anywise touching or concerning the same.

IN WITNESS whereof the parties to these presents have interchangeably set their hands & seals the sd. fourth day of March Anno Domini Seventeen hundred and forty two

Sealed and Delivered
in the presence of
Tho Croasdale
John Callahan

The Mark of
John // Callen (seal)
alias Collins

BE it remembered that on the third day of June in the year of Our Lord Seventeen Hundred and Forty three the within Written Indenture of Mortgages was produced before me Thomas Cookson Esq one of the Justices of the Peace for the County of Lancaster by John Callahan of the City of Philadelphia who made Oath that he saw JOHN CALLEN (al. Collins) within named sign seal & as his act and Deed Deliver the sd. writing indented too the use within mentioned and that he likewise saw Thomas Croasdale of the said City subscribe his name as a _____ thereunto and at the same Time this Deponent also subscribed his Name as a witness thereto.

In Witness Whereof I the said Thomas Cookson have hereunto set my hand and Seal the day & year above written

Recorded the 7th of June 1743.
Thomas Cookson, _____

(43A)"The mortgage was marked as being satisfied on May 8, 1744; however on the same date JOHN CALLEN executed another mortgage covering the same property for the sum of Two hundred fifteen pounds which appears to be a one year lien. No notes found as to whether or when this lien was satisfied, but on Feb 28, 1754 RICHARD PETERS sold the land, or a portion of it, to a JOHN McCLURE."

1744 -- Lancaster Co deeds B64

This Indenture made the Eight day of May in the Seventeenth year of the Reign of our Sovereign Lord George the Second of Great Britain, King - Anno Domini one thousand Seven hundred and forty four Between JOHN CALLEN (alias Collins) of Pennsborough township in the County of Lancaster Province of Pennsylvania Yeoman of the one Part and RICHARD PETERS of the City of Philadelphia in the s province, Gentleman of the other part

WITNESSETH that the said JOHN CALLEN for and in consideration of the sum of Two Hundred and Fifteen Pounds lawful money of Pennsylvania to him in hand well and truly paid and satisfied by the said RICHARD PETERS the receipt whereof is hereby acknowledged Hath Granted Bargained sold Alien'd Released and Confirmed and by these presents Doth Grand Bargain Sell Alien Release and Confirm unto the sd. RICHARD PETERS (in his actual possession now being by virtue of a bargain & sale to him thereof made for one whole year by indenture bearing date the day next before the day of the date hereof by force of the statute for transferring uses into possession) and to his heirs & assigns all that plantation tract or parcel of land situate and being on the West side of Susquehanna River in the township of Pennsboro aforesaid bounded and described as follows (Viz:)

Beginning at a marked Spanish Oak standing the side of Conedogwainet Creek and from thence extending by JOHN WATT'S land South eleven degrees East twenty-four perches to a marked Hickory South fifty one Degrees West twenty two perches to a marked black oak South thirteen degrees West ninety seven perches to a marked Hickory & South seventy degree East thirty nine perches to marked Spanish Oak thence by vacant Land South forty nine degrees West One Hundred & Twenty One perches to a marked Black Oak and South Seventy nine Degrees West Eighty seven perches to a marked Chestnut Oak thence by JAMES ARMSTRONG'S Settlement north fifteen degrees West Two Hundred & Sixty two perches to marked red Oak standing by the said Creek thence down the same Creek on the several courses thereof about three hundred & Ninety two perches to the place of beginning

allowance of six acres _____ for roads & highwaysof which three hundred and sixty two acres of land was granted and confirmed to the said JOHN CALLEN and his heirs in fee? by patent from the Honorable JOHN PENN, THOMAS PENN and RICHARD PENN Esq. true and absolute proprietary and _____ Chief of the said Province and under the hand of the Honorable George _____ Esq. Lieutenant Governor of the said Province by virtue of Crown powers to him for that purpose granted by the said proprietary and _____ the _____ of our Lord One thousand four hundred and forty two as by the said Patent entered in the Office for Recording of Deeds for the City and County of Philadelphia in Patent Book A. Vol 11, page 166. (relation being thereunto had may more fully appear),

Together with all and singular the improvements rights members and appurtenances whatsoever thereunto belonging or in anywise appertaining and all the estate right title interest property claim and demand of him the sd. JOHN CALLEN of in and to the sd. tract of land and presents hereby granted and re _____ and every part thereof and the _____ sums and remainders rents, Issues and profits thereof and deeds, evidences and writings concerning the same or true copys thereof to be had and made at the proper costs and charges of the sd. RICHARD PETERS his heirs or assigns

TO HAVE AND TO HOLD the said described tract of land hereditaments and premises hereby granted and released (except as in the sd. patent is excepted) with the Appts unto the sd. RICHARD PETERS his heirs & assigns to the only proper use and behoof of the said Richard Peters his heirs and assigns forever under the yearly quit rent henceforth growing due and payable to the chief lord or lords.

If the fee thereof and the sd. JOHN CALLEN and his heirs the said tract of land _____ together with the appurtenances hereby granted unto the said RICHARD PETERS his heirs & assigns against him the sd. JOHN CALLEN & his heirs & against all persons claiming or to claim by from or under him, them or any of them, shall and will Warrant and forever defend by these presents and _____ JOHN CALLEN for himself his heirs Extors & admors doth covenant, promise, grant to and with the sd. RICHARD PETERS his heirs and assigns by these presents that he the sd. JOHN CALLEN & his heirs & all every other person & persons whatsoever having or lawfully claiming any estate right title or interest of, in, or to the presents hereby granted or any part thereof by from or under him, them or any of them shall & will at any time hereafter at the reasonable request cost and charges in the law of the said RICHARD PETERS his heirs and assigns make execut and acknowledge or cause so to all and every such farther & other reasonable acts, deeds and conveyances or assurances in the law watsoever for the further and better assuring and confirming the aforesd. tract of three hundred & sixty two acres of land and premises hereby granted with the appts. unto the sd. Richard Peters, his heirs & assigns asd by him or them or by his or their counsel learnt in the law shall be personally devised, advised or _____ quired

In Witness whereof the sd. partys to these presents have hereunto interchangeably set their hands & seals dated the day & year first above written.

The letter or mark of
John // Callen (seal)
alias Collins

Seal'd & Delivered
in the presence of
Edward Shippon
Joseph Shippon

APPENDIX B
CODDLE CREEK, NORTH CAROLINA - LAND DEEDS

July 1788

This Indenture made the 14th day of May in the year of our lord one thousand seven hundred and eighty eight Between PETER BURNS of Mecklenburg County and State of North Carolina of the one part and WILLIAM CALLEN of state and County aforesd. of the other part

witnesseth for and in consideration of the sum of hundred _____ money in hand paid by the sd. WILLIAM CALLEN at or before the insealing and delivery of these the receipt whereof he doth hereby acknowledge and therefore doth release acquit and discharge the sd. WILLIAM CALLAN his heirs Excrs. Admsr. by these presents he the sd. PETER BURNS have granted bargained sold alliened and confirmed and by these presents doth grant bargain sell allien and confirm unto the sd. WILLIAM CALLAN and his heirs and assigns forever one certain tract or parcel of land situate lying and being in the County and state afforesd. being originally granted to the sd. PETER BURNS by the state of North Carolina by pattent bearing date the 22d. of October 1782 - in record referance thereto may more fully appear lying on the east side of Coddle Creek and is bounded as follows

beginning at a W.O. and hickory on a rocky ridge runing thence No.48 E 101 poles to a B.J. next HUGH CAROTHERS thence with his other entry N 26 W 167 poles to a stake thence S 34 W 120? poles to a W.O. near sd. Creek by the corner of his own field then down Sd. Creek with ROBERT CAMPBELLS land to the beginning

containing by estimation 100___ acres be the same more or less and also one other tract or parcel of Land adjoining the above described tract being originally granted to the afforesd. BURNS by state of North Carolina by pattend bearing date 9th October 1783 as record referance thereto had may more fully and at Large appear and is bounded as follows

beginning at a B.J. _____ corner of the new survey above described runs _____ poles to two W.O. then N 75 E 88 poles to a B.O. next HUGH CAROTHERS thence N 20 W 10 poles to two W.O. sapling on WILLIAM MEANS line near his corner thence with Sd. line N 20 W 46 poles to a B.J. sd. MEANS corner then with his other line So. 72 W 78 poles to a B.J. his other corner then with another line of his S 88 W 709? poles to a large W.O. another corner of his on the W of Meadow branch then S ___ W 12 poles to a water oak at the mouth of sd. _____ branch JAMES MEANS corner then So 55 Et. 26 poles to a stake then No 24 So 450 poles to a stake corner of his other survey then with his own line to the beginning

containing by estamation 100 (or 208) acres be the same more or less and all houses buildings and appurtenances thereto belonging or in any wise appertaining and also all the estate right title in trust

presently claim and demand whatsoever of him the sd. PETER BURNS of in and to the sd. premises and writings touching or in any wise conserving the same

To have and to hold the Land hereby conveyed and all and singular the premises hereby bargained and sold with their and every of their appurtenances unto the sd. WILLIAM CALLAN his heirs and assigns forever to the only proper use and behoof of him the sd. WILLIAM CALLAN and of his heirs and assigns forever and the sd. PETER BURNS for himself his heirs Exrs. Admrs. doth Covenant promise and grant to and with the sd. WILLIAM CALLEN his heirs and assigns by these presents the sd. PETER BURNS at this time as _____ of a good survance and _____ estate of inheritance of and in the promises _____ agreed power to grant and convey the survey _____ sd. WILLIAM CALLAN in manner and form _____ the premises now are and so forever thereof to _____ and the _____ and clear of and from all _____ sale dower right and title of dowers _____ and _____ - whatever made dow _____ Committed or suffered by the sd. PETER BURNS or any other person whatsoever - the land _____ hereafter to become due and payable for and in respect of the promises only _____ fited and fore _____ and that the sd. PETER BURNS and his heirs all and singular the premises hereby bargained and sold with the appurtenances unto the sd. WILLIAM CALLAN his heirs and assigns against him the sd. PETER BURNS and his _____ other person or persons whatever _____ and forever defend by these presents _____ hereof the sd. PETER BURNS hath _____ his hand and seal the day and year first above mentioned

Sealed and Delivered
In presence of

William _____
James Carothers

Peter Burns

her
Elizabeth Burns
mark

This Indenture made the 31st Day of December in the year of our Lord one thousand Seven hundred & Ninety Eight Between WILLIAM CALLEN SENR. of the State of North Carolina & County of Cabarrus of the one part and WILLIAM CALLEN JUNR of the State & County aforesd of the other Part Witnesseth that the Said WILLIAM CALLEN SEN for & in Consideration of the Sum of Ninety Pounds in hand pd by the Said WILLIAM JUNR at or before Sealing & Delivering of these Presents the Receipt whereof he the Said WILLIAM SEN doth hereby acknowledge have Bargained Sold Alienated Enfeoffed & Confirmed and by these Presents Do Grant Bargain Sell Alien Enfeoff & Confirm unto the Said WILLIAM CALLEN JUNR his heirs & assigns a Certin Tract or parcel of Land Containing by Survey one hundred acres be the Same More or Less Lying and Being in the County & State aforesd origanally Granted to PETER BURNS and by Convayance to WILLIAM CALLEN SENR lying on the East Side of Coddle Creek

Begining at a white oke & hicory on a Rockey ridge Runing thence N 48 E 110 pole to a Black Jack next HUGH CAROTHERS thence with his other Entry N 26 W 167 poles to a Stake thence S 34 W 128 poles to a White O. Near Sd. Creek by the Corner of his own field thence Down Said Creek with ROBERT CAMPBELLS Land to the Begining

Together also with all Singular the houses & out houses Edifices and Buildiings thereunto Erected & Built & all Rights Members Priviliges & Members Hereditaments premises & appurtinances unto the Said WILLIAM CALLEN JUNR. his heirs & assigns for Ever To have & to hold the aforementioned and Described Tract of Land Hereditaments & Premises with the apertinances unto the Said WILLIAM CALLEN JUNR. his heirs & assigns and he the Said WILLIAM CALLEN SENR. him & Each of his heirs the Said Tract of Land and Premises against him them or Each of them and against all and Every other Person or Persons whatsoever Now having or Lawfully Claiming to the Same or any part of Percel thereof by from or under him them or any of them unto the said WILLIAM CALLEN JUN. his heirs & assigns Shall and will warrant & for Ever Defend Subject Nevertheless to the payment of the yearly quitrents to become Due thereunto

In Witness whereof the Said WILLIAM CALLEN SENR have hereunto Set his hand and affixed his Seal the day & year above written

Signed Sealed & Delivered
In Presents of us
James Scott
John Scott

his
William Callen - Seal
mark

State of North Carolina
Cabarrus County January Session 1799

Then was the Execution of the within Deed acknowledged in open Court by the granter in order to be registered

Test John Simianer C.C.

Book 4 page 238
Cabarrus Co, N.C.
Nov 30, 1801

State of North Carolina No 223

To all to whome these presents Shall come greeting

Know ye that we for and in consideration of the Sum of fifty Shillings for Every Hundred acres hereby granted paid into our treasury by WILLIAM CALLONS have given and granted and by these presents do give and Grant unto the Said WILLIAM CALLONS a tract of Land containing Ninety acres Lying and Being in the county of Cabarrus on Coddle Creek

Begining at a hickory on the branch of Said creek JAMES RUSSELS corner runs thence with Said RUSSELS line north 23 E 170 poles to a white oak his other corner thence with another line of Sd Russels No 71 E 160 poles to a black oak his other corner thence with another line of his No 26 W 135 poles to a cluster of post? oaks JAMES CAROTHERS corner thence with another line of his N 32 E 114 poles to a black Jack in Sd Carothers line thence north five W 26 poles to a black Jack WILLIAM CALLONS SENRS corner thence with his lines So 45 W 88 poles to two white oaks Sd CALLONS thence with his other line South one hundred and twenty poles to a black jack hisother corner thence his other line So 48 W 101 poles to a white oak & hicory another of his corners thence with his other line So 25 W 220 poles to a black on Coddle Creek Branch thence Down Said creek to the Beginning

Entered the 15th of November 1798 as by the plat hereunto annexed do they appear together with all woods waters mines minerals hereditiments & Appurtenances to the Said land Belonging or appertaining to hold to the Said WILLIAM CALLONS his heirs and assigns forever yeilding and paying to us Such Sums of money yearly or otherwise as our General Assembly from time to time may Direct provided always that the Said Grantee Shall cause this grant to be Registered in the Registers office of our Said county of Cabarrus within twelve months from the Date hereof otherwise the Same Shall be void

In testamony whereof we have caused these our letters to be made patent and our great Seal to be hereunto affixed

Witness B Williams Esq our governor capt general and commander in chief at Releigh the 30th Day of November in the 26th year of our Independence and in the year of our Lord 1801

by command

B Williams

Will White Secretary

Book 4
Cabarrus Co N.C.
March 30, 1803

This Indenture made this thirteenth day of March in the Year of our Lord one thousand Eight hundred and three Between WILLIAM CALLONS of the one part & THOMAS CALLONS of the other part witnesseth that for and in consideration of the Sum of two hundred pounds to him in hand paid by the Sd. THOMAS CALLONS the receipt where of is hereby acknowledged the said WM CALLONS hath given granted Bargained Sold and Confirmed and by these presents doth give grant Bargain Sell and Confirm to the Sd THOMAS CALLONS his heirs and assigns forever all that tract or parcel of Land Containing by Survey one Hundred acres Situate Lying and Being on the East Side of Coddle Creek

Beginning at a B.Jack second corner at a New survey runing thence N 120 poles to 2 W.O then N 45 E 88 pole to B.Jack then N 20 W 18 poles to 2 W.O. saplins MEANSES line near his corner then with Sd Line N 80 W 46 poles to a B.J. sd Meanses corner then with his other line So. 72 W 78 poles to a B.J. thence with his other line So 88 E 184 poles to a large WO on the Wolf Meadow Branch then So 3 W 12 poles to water oak at the mouth of Sd Branch then So 55 E 26 poles to Stake thence North 84 E 150 poles to a Stake a corner of another Survey thence to the Beginning

To have and to hold said tract of Land with all the appurtenances thereunto belonging to him the Said THOMAS CALLONS his heirs and assigns forever and the said WM CALLONS for himself his heirs Excers Admrs & doth covenant promise and agree to & with the Said THOMAS CALLONS his heirs and assigns shall and may forever hereafter peaceably & quietly have hold occupy and Enjoy the Said land without the let or molistation of him the Sd WILLIAM CALLONS his heirs and assigns or any other person or persons whatforever and the Sd WM CALLONS doth oblige himself his heirs & assigns to Warrant & defend to the Said THOMAS CALLONS his heirs & assigns the Said tract of Land from the Lawfull Claim or Claims of all persons whatforever as Witness my hand and Seal the day & Date above Written

Signed Sealed & Delivered
In the presents of
George Campbell, _____
Joseph Rays (or Ross)

William Callon Seal
his mark
her
Ell _____ Campbell Seal
mark

State of North Carolina
Cabarrus County
July session 1803

It is hereby certified that the within Deed was duly proved in open Court by the oath of George Campbell recorded & ordered to be Registered

Test John Simianer C.C.

Book 5
Cabarrus Co., N.C.
April 19, 1805

This Indenture Made the 19th Day of April 1805 Between WM. CALLONS SENR of the County of Cabarrus and State of North Carolina of the one part and WM CALLANDS JUNR. of the County & State aforesaid of the other part

Witnesseth that for & in Consideration of the Sum of 400 Dollars to him in hand paid by the sd. WM. CALLANDS JUNR. at & before the Sealing & Delivery of these Presents the receipt whereof is hereby acknowledged Hath granted Bargained Sold Aliened enfeoffed Convayed & Confirmed ___ & ___ unto the Said WILLIAM CALLANDS JUNR. a parcel or Tract of Land Situate Lying & Being in the County of Cabarrus & on the East Side of Coddle Creek

Begining at a B.J. & corner of a New Survay of the Plantation he Now lives on & runs then N 120 pole to Two white oaks then N 45 E 88 pole to a B.J. Near HUGH CAROTHERS then N 20 W 18 pole to Two W.O. Saplines on WM. MEANSS line Near his Corner thence with Said line N 80 W 46 pole to a B.J. Said MEANSS Corner thence with his other line 72 W 78 pole to a B.J. his other corner thence with another line of his So. 80 W. 180 pole to a Large W.O. another corner of his on the Wolf Meadow branch thence So 3 W 12 pole to a Water O. at the Mouth of sd. branch JAMES MEANSS corner thence So 55 E 26 pole to a Stake thence N 84 E 150 pole to a Stake a corner of his other Survay thence with his own line to the begining

Containing 100 acres To have & to hold the aforesaid piece or parcel of Land with the hereditaments & premises unto him the Said WILLIAM CALLANDS JUNR his heirs & assigns forever &&& which Comprehends all & every of the appurtanances Whatsoever Claiming or Lawfully to Claim

In Witness Whereof the Said WILLIAM CALLANDS SENR to these Presents hath Set hs hand and affixed his Seal the day & year first above written

Signed Sealed & Delivered
In the Presents of
Daniel Dougharty
John Dougharty

his
William Calland
mark

April Session 1805

Then was the Execution of the within Deed acknowledged in open Court by the grantor recorded and ordered to be Registered

Test John Simianer C.C.

Book 10
Cabarrus Co., N.C.
July 25, 1811

This Indenture made this 25th day of July A.D. 1811 & in the Thirty fifth Year our American Independence Between JAMES CALLONS of the state of N Carolina & County of Cabarrus of the one part & JOHN HOUSTON PLUNKET of the state & county aforesd of the other part Witnesseth that for & in consideration of the sum of six dollars per acre current money of the state of N. Carolina in hand paid to him the sd. JAMES CALLONS by his the sd. JOHN H PLUNKET the sd. JAMES CALLENS Hath Bargined & sold & by these presents doth Bargain sell alien & Confirm unto the Sd. JOHN H PLUNKET his Heirs & assigns forever A certain Tract or parcel of land situate in the county of Cabarrus & on the waters of Coddle creek

Begining at a B.O. sd. JAMES CALLENS corner runs thence N 75 W 77 poles to a Hickory grub in the lines of sd Survey runs thence N 99 poles to a B.j then E 22 poles to a B.j. then N 45 E 87 poles to a B.O on the bank of the creek then down the creek as it meanders to a B.O. at the mouth of a Branch then S 16 W 141 poles to a B.j. thence S 65 E 18 poles & 22 links to a B.j. thence S 10 W 55 poles to the begining

Containing by Estimation 69 acres be the same more of less - Being a part of a 205 acre tract granted by State to SAML GARRISON & Conveyed by him to CHARLES CAMPBELL & from the sd. CAMPBELL to the aforesd JAMES CALLENS & from sd. CALLENS to JOHN H PLUNKET as may be seen by the Registers books of sd. County

To have & to hold the aforesd Tract of land Hereditaments & premises hereby granted unto the sd. JOHN H PLUNKET his Heirs & assigns forever with all the rights & priviledges members & appurtenances whatsoever together with the Reversion & reversions remainder & Remainders & profits thereof or the the same in any wise belonging to the only proper use benefit & behoof of him the sd. JOHN H PLUNETT his Heirs & assigns for ever that he will for ever warrant & defend the aforesd Tract of land with all the priviledges thereof unto his the sd. JOHN H PLUNKET his Heirs & assigns for ever against the sd. JAMES CALLENS his Heirs & assigns & all & everyother person or persons laying any lawful claim hereunto in any wise whatsoever

In witness whereof the sd. JAMES CALLENS hath hereunto set his hand & affixed his seal the day & year first above written

Signed Sealed & delivered in the presence of
James S Plunket
Samuel Erwin

James Callens

State of N Carolina
Cabarrus County

April Session 1822

I John Travis clerk of the court of pleas & quarter sessions Do

hereby certify that the execution of the within deed was duly proved
in open court by the oath Sam'l Irwin a Subscribing witness
thereto Recorded & ordered to be Registered

Witness John Travis C.C.

Book 9
Cabarrus Co., N.C.
Nov. 28, 1815

page 69 April Term 1818

State of N. Carolina No 452

Know Ye that we for & in consideration of the sum of Fifty Shillins for every hundred acres hereby granted paid into our treasury by WILLIAM CALLENS - Have given & granted & by these presents do give & grant unto sd. WM. CALLANS a tract of Land containing five & one quarter acres lying & being in the County of Cabarrus on the East side of Coddle creek Joining JAMES RUSSELS SENR. & his own land

Begining at a p.o. & W.o. on the bank of Codle creek JAMES RUSSELS corner runs thence with JAS. RUSSELS line North Eighty two degs. West forty four poles to a p.o. sd. RUSSELS corner thence with sd RUSSELS line North thirty two degs East Eight three poles to a p.o. sd. RUSSELS corner & his own thence with his own line South thirty eight & a half degs. West one hundred and three poles to a Hickory his own corner on the bank of the creek thence down the creek as it meaders to the Begining

Entered 28th of Nov 1815 - As by the plat hereunto anexed doth appear together with all woods waters mines Minerals Hereditaments & appurtenances to the sd. Land belonging or appertaining To hold to sd. WM. CALLENS his Heirs & assigns forever Yielding & paying to us such sums of money yearly or otherwise as our General assembly from time to time may direct provided Always that the sd. Grantee shall cause sd. grant registered in the registers office of our sd. County of Cabarrus within twelve months from the date hereof otherwise the same Shall be void

In Testimony whereof we have caused these our letters patent and our great seal to be thereunto affixed

Witness

Wm Miller Esqr. our Governor Capt. General & Commander in Chelf at Raleigh the 19th day of Sept In the forty first year of our Independance & in the year of our Lord One thousand eight hundred & Seventeen

By Command

Will Miller

Wm Hill Secretary

Book 9
Cabarrus Co, N.C.
Nov 25, 1819

State of N Carolina 386 No 529

Know ye that we for & in consideration of the sum of one hundred Shillings for every hundred acres hereby granted paid into our Treasury by WILLIAM CALLAN'S hath given & granted & by these presents doth give & rant unto the sd. Wm Callans a Tract of Land lying in the county of Cabarrus & on the East side of Coddle creek Joining his own & the Heirs of W.L. ALEXANDER'S

Begining at a Hickory & horn beam on the bank of the creek on his own line runs with his line N 25 E 38 poles to a p.o. & Hickory his own corner of a hundred acre tract thence with a line of sd. tract n 0 W 24 poles to a W.O. on the bank of sd. creek thence down the creek as it meanders with ALEXANDERS line to the begining

Entered 25th of Nov 1819

As by plat hereunto annexed doth appear Together with all woods waters mines minerals Hereditaments & appurtenances thereunto belonging or appertaining

To hold to the sd. WM. CALLENS his Heirs & assigns for ever - Yeilding & paying to us such sums of money yearly or otherwise as our Genl Assembly from time to time may direct

Provided alway the sd. grantee shall cause this grant to be Registered in the registers office of our sd. County of Cabarrus within twelve months from the date hereof otherwise the same shall be void

In testimony whereof we have caused our letters to be patt_____ & our great seal to be thereunto affixed

Witness John Branch Esqr our Gov Capt Genl & Commander in chief at Raleigh the 7th day of July in the 45th year of our Independance & in the year of our Lord one thousand eight hundred & twenty

By Command Jno Branch
Will Hill Secretary

This Indenture made this 25th day of July 1811 & in the year of our Independence the Thirty fifth Between JAMES CALLENS of the county of Cabarrus & State of N Carolina of the one part & JOHN H PLUNKET of the aforesd County & State of the other part Witnesseth that the sd. JAMES CALLENS for & in consideration of the sum of six dollars per acre which makes three hundred & Seventy eight dollars to him in hand paid by the sd. JOHN H PLUNKET Executing & delivering of these presents the payment & rect. whereof we have by acknowledge by the sd. JAMES CALLENS & by these present doth give grant Bargin & Sell alien & confirm unto the sd. JOHN H PLUNKET all that tract of land or parcel of Land Situate lying & being on the waters of Coddle creek

Begining at a Hickory & a RO sapling in the line of JOHN H PLUNKET thence with his line S 15 W 54 poles to a pointer a corner in the old survey then with the sd. line S 58 W 87 poles to a R.O the 2nd corner of sd Survey then with the 2nd line of the survey N 38 W 40 poles to a R.O the 3rd corner of the survey then with the 3rd line N 10 E 54 poles to a B.O. the 4th corner of the Survey thence with the 4th line N 65 W 18 poles to a B.J the 5th corner of the Survey then with a line of the old survey N 16 E 57 poles to a stone corner sd. line HUGH ROSS'S corner thence with sd ROSS'S S 67 E 110 poles to the begining

Containing by Estimate 68 acres more or less To have & to hold the sd. Tract of land Hereditaments & premisis to the sd. JOHN H PLUNKET Together with Reversions & Remainders & profits thereof to the same in any wise belonging to the only use benefit & behoof of the sd. JOHN H PLUNKET his Heirs & assigns forever & the sd. JAMES CALLENS doth hereby grant covenant & agree & grant for himself & his Heirs he will for ever warrant & defend the sd. Tract of land with all the privileges therof to him the sd. JOHN H PLUNKET his Heirs & assigns forever against the claim of the sd. JAMES CALLENS his Heirs & assigns & all & every other person or persons laying any lawful claim thereto in any wise whatsoever

In witness whereof the sd. JAMES CALLENS Hath hereunto set his hand & affixed his seal the day & year written

Sealed & delivered in the presence of
James L Plunket
Sam'l Erwin

James Callens

State of N Carolina
Cabarrus County

April Session 1822

I John Travis clerk of the court of pleas & Quarter sessions do hereby certify that the Execution of the within deed was duly proved in open court by the oath of Sam'l Erwin

Recorded & ordered to be Registered

Witness: John Travis C.C.

APPENDIX C
GOOSE CREEK Area, NORTH CAROLINA - LAND DEEDS

1795

This Indenture made June 25, 1795. Between WILLIAM MCKEE
Mecklenburg County in North Carolina of the one part and JOHN
CALLEN of the other part

Witnesseth that Whereas the said WILLIAM MCKEE Esq by virtue _____
Sheriff under the Act of Assembly for _____ regular collecting of
_____ the publick taxes did seize _____ a tract or
parcel _____ on the waters of Goose Creek

Beginning at a P.O. his own old corner _____ then N 37 E 51 poles
to a _____ poles to a Sassafras _____ then N 71 W
70 pole to a P.O. _____ to a pine then S _____ &
then to the beginning

Containing _____ acres be it more or less the sd. WM MCKEE Sheriff
as afforesaid _____ due Advertisement according to law did cause
the sd. parcel of land with all the appurtenances _____ belonging
to be past up at publick sale to the highest bidder _____ 25th day of
June A.D. 1795 at which time & place the said JOHN CALLEN became the
last and highest bidder at the sum _____ Shillings for the said
land with the appurtenances thereunto _____ belonging.

This Indenture therefor Witnesseth that the _____ WILLIAM MCKEE
Sheriff as afforesd. for & in consideration of sum of ten Shillings
to him in hand paid by the sd. JNO CALLEN _____ before the signing &
sealing of these presents the Receipt _____ hereby acknowledged he
the said WM. MCKEE Sheriff hath _____ in sale alein enfeoff
convey & confirm unto the Sd.

John Callen

JOHN CALLEN his heirs & assigns forever all the afforesd land and
_____ taments and emolements? thereunto belonging or _____
appurtaining

To have and to hold to him the sd. JNO his heirs & assigns forever
in as full and ample manner the Sd Sh _____ is _____ possessed? by
Virtue of his office and for sd. WILLIAM MCKEE Sheriff hath hereby
covenant promise to him and at all times hereafter have hold occupy
the sd. premises with all the appertinances thereunto be free and
clear of and from all rememberances had made him the sd. Sheriff or by
his order & that he the said WILLIAM MCKEE will warrant and defend
the same to the said JOHN CALLEN and assigns forever so far as office
of Sheriff will admit and _____.

In Witness whereof the sd. WM MCKEE Sheriff of Mecklinburg hath
hereunto set his hand and affixed his seal the day & year above
written.

Signed Sealed & delivered in presence of

J.R. Darnall

Wm McKee, Sheff.

Mecklenburg County Probate? Court 1810 this Deed was acknowledged &
recorded Teste Issac Alexander Call registered Dec 16, 1810

This Indenture made March 17th 1810 Between HENRY PRICE of Mecklenburg in North Carolina of the one part and JOHN CALLIN of the same place of the other. Witnesseth that for & in the consideration of the sum of 390 Dollars in hand paid by said JOHN CALLIN to the Sd. HENRY PRICE the rect whereof is hereby acknowledged the s'd HENRY PRICE hath sold & by these presents doth sell convey & deliver & confirm unto the said JOHN CALLIN a certain piece or parcel of land on the waters of Goose Creek as follows:

Beginning at a R.O. thence S 50 W 47 poles to a B.O. then N 40 W 100 poles to a P.O. thence _____ poles to a R.O. then N 37 E 51 _____ small R.O. Then N 24 E 82 poles to a Sassafras then N 4 W 46 poles to a P.O. then N 51 E 52 poles to a B.O. then S 37 E 52 _____ B.O. the old line then with said line S 37 W 25 poles to a pine in Sd. line then S 45 E 106 to a large pine JAMES BLAIN cor _____ then with his line S 29 W 170 poles to a _____ said BLAINS Corner and then N 47 W 14 poles to the beginning

by survey 200 acres be the same more or less

To have & to hold the above specified land & premises with all the improvements, houses, orchards woods waters mines & minerals _____ same belonging or in any wise appertaining to the _____ use & behoof of the sd JOHN CALLIN his heirs & assigns for ever. and the Sd HENRY PRICE doth for him self his heirs Execurs & Adminrs Covenant & agree to & with the sd JOHN CALLEN to _____ & to defend the above 200 acres of land against the lawful claim of any person whatsoever now claiming or for ever hereafter lawfully to claim _____

In witness whereof the Sd HENRY PRICE have hereunto set my hand & seal the day & year _____

Signed Sealed & delivered in presence of

Robert Allen

Mecklenburg County, July Court 1810. This deed was proven & recorded
Tester Isaac Alexander

Registered Aug. 28, 1810

December 30, 1822
State of North Carolina No 2543

Know Ye, That we, for and in consideration of the sum of Ten Dollars for every hundred acres hereby granted, paid into our Treasury by JOHN CALLEN have given and granted, and by these presents do give and grant unto the said JOHN CALLEN a Tract of Land containing twenty Acres lying and being in the county of Mecklenburg on the waters of Goose Creek

Beginning at a stake the ending corner of his own old Survey and runs South thirteen East forty pole to a post Oak by the Road DAVID MOORE corner then with two of his lines North seventy East twenty eight pole to a post Oak then North eighty four East forty eight pole to a post Oak Moore corner then with his line South forty five East Eighteen pole to a post Oak by a hollow then North forty East twelve pole to a Dogwood on his own line, then with said line North thirty four West forty pole to a post Oak by the Road his own old corner, then with the line of the MCKEE Survey to the Beginning

Entered the 30th of December 1822

as by the Plat hereunto annexed doth appear, together all Woods, Waters, Mines, Minerals, Hereditaments and Appurtenances, to the said Land belonging or appertaining:

To hold to the said JOHN CALLEN his heirs and assigns forever; Yeilding and paying to us such sums of money, yearly or otherwise, as our General Assembly from time to time may direct:

Provided Always, That the said Grantee shall cause this Grant to be registered in the Register's Office of our said county of Mecklenburg within twelve months from the date hereof, otherwise the same shall be void.

In testimony whereof, we have caused these our Letters to be made Patent, and our Great Seal to be hereunto afixed.

Witness, Gabriel Holmes, Esquire, our Governor, Captain General and Commander in Chief, at Raleigh, the 30th day of November in the 49th year of our Independence, and in the year of our Lord one thousand eight hundred and twenty four.

By command,

Wm Hill Secretary

Gab Holmes

December 30, 1822
State of North Carolina No 2544

Know ye, That we, for and in consideration of the sum of ten Dollars for every hundred acres hereby granted, paid into our Treasury by JOHN CALLEN have given and granted, and by these presents do give and grant unto the said JOHN CALLEN a Tract of Land containing ninety Acres lying and being in the county of Mecklenburg on the waters of Goose Creek

Beginning at a pine his own corner and runs with two of his own lines North forty seven East thirty six pole to a post Oak, then South seventy one East seventy pole to a post Oak his own and DAVID KERR corner and runs with KERR line North thirty four West one hundred and twenty two pole to a post Oak KERR corner then South sixty one West seventy six pole to a post Oak by the Dutch Road then with said Road South forty one West one hundred and two pole to a post Oak by said Road David _____ corner then with his line South fourteen East one hundred and two pole to a black Oak Moore corner on his own line, then with his own line to the Beginning

Entered 30th of December 1822

as by Plat hereunto annexed doth appear, together with all Woods, Waters, Mines, Minerals, Hereditaments and Appurtenances, to the said Land belonging or appertaining:

To hold to the said JOHN CALLEN his heirs and assigns forever: Yielding and paying to us such sums of money, yearly or otherwise, as our General Assembly from time to time may direct: Provided Always, That the said Grantee shall cause this Grant to be registered in the Register's Office of our said county of Mecklenburg within twelve months from the date hereof, otherwise the same shall be void.

In testimony whereof, we have caused these our Letters to be made Patent, and our Great Seal to be hereunto affixed.

Witness, Cabl Holmes Esquire, our Governor, Captain General and Commander in Chief, at Raleigh, the 30th day of November in the 49th year of our Independence, and in the year of our Lord one thousand eight hundred and twenty four.

By Command

Wm Hill Secretary

Gab Holmes

APPENDIX D
misc NORTH CAROLINA - LAND DEEDS

Book 2
Cabarrus Co, N.C.
Aug 1, 1795

This Indenture Made the first day of August in the Year of our Lord one thousand Seven hundred and Ninety five Between WM CALLENS and EIANER his Wife of the State of North Carolina & County of Cabarrus of the one part and JAMES BURNS of the County and State aforesaid of the other part Witnesseth that for and in Consideration of the Sum of Sixty pounds Currant Money of the aforesd State to the Said WILLIAM CALLENS in hand paid By the Said James Burns at and Before the ensealng and Delvering of these presents the receipt and payment Whereof is hereby acknowledged Hath granted Bargained Sold aliened enfeoffed Convayed and Confirmed and by these presents doth Grant Bargain Sell alien enfeoff Conway and Confirm unto the Said JAMES BURNS his heirs and assigns forever a Tract of Land Containing one hundred acres Lying & Being in the County of Cabarrus on the Waters of Rockey River

Begining at a pine JAMES WHITES Corner of a New Survay runing thence with Said Whites Line North 46 East 108 pole to Two White oaks his other Corner thence with his other Line North Eleven East Seventy five pole to a Black oak an other Corner of his thence with another line of Said Whites North 73 East thirty pole to a Stake on Said Line thence North 55 pole to a Black Jack thence North & West Seventy pole to a Stake on Scotts Branch thence South fifty Seven West one hundred poles to a hickory thence South forty Six West Sixty pole to a White oak Said Scotts old Corner thence North Said line South Ten West forty Two pole to a Stake his old Corner thence to the Beginning as by the original plan may appear

Containing the above Mentioned Number of acres Be the Same More or Less and also with all and singular the Houses and outhouses edifices and Buildings thereunto Erected & Built and all right and advantages hereditaments & premises with the appurtenances unto the Said JAMES BURNS his heirs and assigns for to have and to hold the aforementioned Bounded & Described Tract of Land Hereditaments and premises with the appurtenances unto the said JAMES BURNS his heirs and assigns and he the Said WILLIAM CALLENS him and each of his heirs the Said Tract of Land and premises against him them or Each of them and against all and every of them or any other person or Persons whatsoever Now haveing any Lawful Claim to the Same or any part thereof by from or under him them or any of them to the Said JAMES BURNS his heirs and assigns Shall and will warrent and forever Defend Subject Nevertheless to the payment of the yearly Quitrents to Become Due thereon

In Witness Whereof the Said WILLIAM CALLENS and ELEONER his wife have hereunto Set their hands and affixed their Seals the day and year first above Written

Signed Sealed and Delivered

Wm Callens - seal

State of North Carolina

Cabarrus County

April Term 1797

His hereby Certified that the within Deed was duly proved in open Court by the oath of William Scott recorded and ordered to be registered

Test John Simianer C.C.

Book 5
Page 159
Cabarrus Co, N.C. 1801

State of North Carolina
To all to whom these Presents shall come Greeting

Know ye that we for & in consideration of the sum of fifty Shillings for Every hundred acres hereby granted Paid into our treasury by THOMAS CALLONS have given & granted & by these presents do give & grant unto the Said THOMAS CALLONS a tract of land, containing thirty acres lying & Being in the County of Cabarrus on the North East Side of the Mulberry Branch

Beginning at a stake on the banks of Sd. Branch & HUGH PERKINS corner & runs with WILLIAM HARRIS's line N 29 E 50 pole to two Post Okes THOS. HARRIS's other Corner then with another line of Sd Harris's N 47 West 70 pole to a B.J his other corner thence N 28 West 45 pole to a Stake in ALEXANDER ALLONS line thence with Sd line South 55 West to a hickory Sd. Allons & Perkins other corner thence to the Beginning

Entered January 2, 1801 to hold to the Said THOMAS CALLONS his heirs and assigns forever.

In Testimony Whereof we have caused these our Letters to be Made Patent by our Great Seal to be hereunto affixed

Witness Benjamin Williams Esq. our Governor Captain General & Commander in Chief at Raleigh the 25th day of Sept. in the 26th year of our Independence & in the Year of our Lord 1801 by Command.

Will White Secretary

B. Williams

Book 9
Cabarrus Co., N.C.
January 14, 1809

Page 127 July Term 1818

This Indenture Made this 14th day of January & in ye Year of our Lord one thousand eight Hundred & nine Between JOHN CALLEN of the County of McLenburg & State of N Carolina of the one part & JAMES DICKSON of the County of Cabarrus & State aforesd. of the other part Witnesseth that for & in Consideration of the sum of Four hundred & Ninety five Dollars to him in hand paid the rect. whereof is hereby acknowledged the sd. JOHN CALLENS Hath given granted Bargined & Sold & by these presents doth give grant Bargin & Sell unto him the sd. JAMES DICKSON & his assigns for ever a certain piece or parcel Land lying in the County of Cabarrus on the North Side of Rocky river formerly the property of JOHN MITCHES being Subdivided from his old tract by a deed of Conveyance from him to JOHN CALLENS December the 6th 1798

Begining at a hickory near the Bank of sd. River thence N 26 E 128 poles to a B.O Sapling thence N 53 W 50 poles to a B.j in the fork of the ridge road thence S 50 west 14 poles to a p.o thence S 48 W 72 pole to a Hickory grub thence S 24 W 36 poles to a Hickory on the bank of the river thence down the river as it meanders to the begining

Containing Sixty acres as by the Platt hereunto annexed doth appear

To have & to hold the aforesd. piece of land with all the appertenances privileges & Improvements to the land belonging or in any wise appertaining to the sd. JAMES DICKSON his Heirs & assigns forever & the sd. JOHN CALLENS doth Covenant & agree to & with the sd. JAMES DICKSON that his Heirs & assigns shall Occupy possess & Enjoy the aforesd granted Land & premissis without the ___ or molestation of any person or persons whatever & clear from all manner of Incumberance whatever & the sd. JOHN CALLENS doth for himself his Heirs Exec. Adms. Covenant & agree to & with the sd. DICKSON his Heirs & assigns for to warrant & defend the aforesd land & premises to him the sd JAMES DICKSON his heirs & assigns forever against the claims of any person now claiming or hereafter to claim

In Witness whereof he the sd. JOHN CALLENS hath hereunto set his hand & affixed his seal the day & year above written

Signed Sealed & delivered
In the presence of
John Allen
Robt White
I McLellan -(or J. McLellan)
David Long

John Callen

within deed by JAS A CALLENS to JOHN PHIFER & as full Satisfaction has been made to me by JAS A CALLENS & further consideration of ten dollars to one in hand paid by the sd. JOHN PHIFER the rect wherof is hereby fully ackd. I do hereby in consideration of sd. sum of ten dollars & other good consideration from JAMES A CALLENS Bargain sell alien & confirm unto JOHN PHIFER all my right Interest & title of & in the land contained within the described bounds to have & to hold the same to the proper use & behoof of the sd. JOHN PHIFER his Heirs & assign against myself & all claiming under me so far & as long as my Interest the sd. land extends

Witness my hand & Seal this 12th Oct 1829

— Alexander

her
Sarah Callens
mark

State of N Carolina
Cabarrus County

Oct. Sess 1829

I JAS G SPEARS Clerk of the court of Pleas & Quarter Sess. for sd. county Do hereby certify that the Execution of deed & relinquishment were both proven in open court by the oath of MO'S ALEXANDER recorded & ordered to be registered

Jas G Spears Clk

Book 11
Cabarrus Co, N.C.

October 12, 1829

This Indenture made the 12th day of Oct In the year of our Lord one thousand eight hundred & twenty nine Between JAMES A CALLENS of the county of Cabarrus & State of N. Carolina of the one part & JOHN PHIFER of the county & State aforesd. of the other part Witnesseth that the sd JAS. A CALLENS for & in consideration of the sum of Six hundred & five dollars to him in hand paid by the sd. JOHN PHIFER the rect. whereof the sd. JAS. A CALLENS doth hereby acknowledge Hath given granted bargined & Sold aleined & Confirmed & by these presents doth give grant bargain & Sell alien convey & Confirm unto JOHN PHIFER his Heirs & assigns all that Tract of land Situate in the county & State aforesd.

Begining at a B.j. old corner near the fence runs with WM R FARRS land N 88 W 60 pole a Hickory on FARRS line corner then with PHIFERS land N 10 E 25 pole a P.O. then N 82 E 224 pole a P.O. PHIFER corner Joining SCOTTS land then S 25 E 13 pole an Ash then S 62 W 44 pole a B.j. thence S 20 E 20 pole a Stake on old line a corner of the 4th lot then N 70 W 128 pole a B.j. then S 33 W 5 pole the begining

Containing 60 1/2 acres - Also the woods ways waters water courses & all & every the appurtenances thereunto belonging or in any wise appertaining & the reversion & reversions remainder & remainders _____ unto Issues & profits of the aforesd. land & premesis & every part thereof & all the Estate right title claim property & demand whatsoever of the sd. JAMES A CALLENS of in & to the land & premises hereby granted

To have & to hold the aforesd land & premises with the appurtenances unto the sd. JOHN PHIFER his Heirs & assigns to the proper use & behoof of the sd. JOHN PHIFER his Heirs & assigns forever & the sd. JAMES A CALLENS for himself & his Heirs the aforesd. land & premesis & every part thereof against him & his Heirs & against the claim or claims of all & every other person or persons whatsoever to the sd. JOHN PHIFER his Heirs & assigns shall & will forever warrant & defend by these presents

In testimony whereof the sd. JAS A CALLENS hath hereunto set his hand & affixed his seal the day & year first above written

Sealed & delivered Thos G Martins
in the presence of Mo's Alexander (Moses)
Robt Ferguson

James A Callens

State of N Carolina
Cabarrus County

As several acres of any Dower right in the lands of WM CALLENS decd. is contained within the Boundries the land conveyed in the

BIBLIOGRAPHY

PENNSYLVANIA RESOURCES

- 1 "Commemorative Biographical Record of Central Pennsylvania" Vol II by J.H. Beers & Co Chicago 1898
- 2 Cumberland County, Penna court house records (land records, tax lists, etc)
- 3 Bedford County, Penna court house records (land records, tax lists, etc)
- 4 Westmoreland County, Pa court house records (land records, tax records, wills, etc)
- 5 Pennsylvania Archives
- 6 Pennsylvania death certificates
- 7 "History of Allegheny County, Pennsylvania" Vol 1 Chicago, Ill A. Warner & Co, Publ 1889
- 8 "Frontier Forts of Pennsylvania" Vol II 2nd Edited by Thomas Lynch Montgomery Litt. D Harrisburg Pa - William Stanly Ray - State Printer 1961
- 9 "History of Armstrong County, Pennsylvania" by Robert Walter Smith, Esq Chicago: Waterman, Watkins & Co. 1883
- 10 "Biographical & Historical Cyclopedia of Indiana and Armstrong Counties, Penna" by Samuel T Wiley
- 11 Armstrong County, Pa court house records (wills, land records, marriage records, etc)
- 12 Armstrong County, Penna. - cemetery inscriptions
- 13 "History of Clarion County, Pennsylvania" by A.J. Davis Syracuse N.Y. published by D. Mason & Co. 1887
- 14 Callensburg Centennial book
- 15 "History of Callensburg and Vicinity" read by Rev. O.A. Elliott on Christmas Evening, A.D. 1874 - copied from a 7 part newspaper article - the name of the newspaper and date of the articles are unknown taken from "Callensburg a Small Community" compiled by Arnold Kepple
- 16 Clarion County, Penna - cemetery inscriptions
- 17 Clarion Co, Pa- court house records

- 18 "Jefferson County Pennsylvania Her Pioneers and People" Vol II Chicago J.H. Beers & Company 1917
- 19 "Pioneer History of Jefferson County, Pa" McKnight Lippincott 1898
- 20 Jefferson County court house records
- 21 Jefferson Co, Pa - cemetery records
- 22 Newspaper article from "Jeffersonian Democrat" Thurs. Nov 3, 1983
- 23 "History of Butler County" pg 257-8
- 24 "History of Butler County" pg 862
- 25 Butler Co, Pa -newspaper clippings, obituaries
- 26 Butler Co, Pa - court house records
- 27 Butler Co Pa - cemetery records
- 28 Hugh Callen Sr?? family Bible - in family possession.

GENERAL RESOURCES

- 29 U.S. census records
- 30 U.S. Military & pension records
- 31 RLDS Index

LINE OF PATRICK CALLEN

PATRICK/ ELEANOR

- 32 Research by Candice Livengood

PATRICK/ HUGH SR/ THOMAS

- 33A Research by Edna (Callen) McNellis
- B Information supplied by Hazel (Callen) Buccigrossi(d)
- C Information supplied by Lloyd T Callen; Thompson Callen; Walter E Callen
- D Information supplied by Paul E Callen
- E Information supplied by Dorothy (Callen) Townsend(d); Tillie Nale, Della Berlin
- F Information supplied by Betty and Joe Callen
- G Information supplied by Jeff Callen and Arthur B Callen
- H Information supplied by Paul Stahlman
- I Information supplied by William A Callen

PATRICK/ HUGH SR/ SAMUEL

- 34A Information supplied by Dr Harry E Callen, Jr
- B Information supplied by Mrs Donald R Callen Sr
- C Information supplied by Charles Freeman Callen
- E Information supplied by Joseph Worthington Callen(d)

PATRICK/ HUGH SR/ WATSON

- 35A Research by Win Ballenger(d)
- B Research by Peggy Allen
- C Research by Velma (Callen) Herod
- D Personal family remeberances passed through the family as told by Watson, to John Harvey, to George Walter to Peggy Allen
- E Article "Alumnus' Ancestors Founded, Pa Town" by DPC
- F Information supplied by Craig Callen
- G Information supplied by Barry Callen
- H Information supplied by Mike Callen
- I Information supplied by Samuel Watson Callen Jr
- J Information supplied by Marshall K Callen
- K Information supplied by John L Callen
- L Information supplied by John Bird
- M Information supplied by Kathy (Callen) Peterson
- N Information supplied by Fred C Callen; Victor A Callen
- O Information supplied by Tony Vern Callen

PATRICK/ HUGH SR/ JAMES

- 36A Information supplied by Blanche (Bashline) Silves(d)
- B Information supplied by James R Callen

PATRICK/ DAVID

- 37A Research by Bessie (Callen) Leal
- B Research by Claude P Callen(d)
- C Information supplied by Wilbur Dean Callen
- D Information supplied by Delbert "Bob" Callen
- E Information supplied by John Elliot Callen
- F Information supplied by Melinda Marlax

LINE OF SAMUEL CALLEN

- 38 Missouri - cemetery inscriptions
- 39 Andrew Co, Missouri - court house records
- 40 McBryar Family History
- 41 Cemetery index from Poke Run Cemetery, Apollo, Pa
- 42 Brownville story
- 43A Research by Dorothy (Callen) Laird
- B Research by Gladys Callen
- C Research by Francis(d) and Georgia R Callen
- D Information supplied by Mae (Callen) Poszywak

- 43E Information supplied by Beulah (Campbell) Callen
- F Information supplied by Catherine (Ludke) Callen
- G Information supplied by Paul Callen
- H Information supplied by Edward Dickey Callen
- I Information supplied by Valerie K Callen
- J Information supplied by Wilbur Dean Callen

LINE OF WILLIAM CALLEN SR

- 44 "History of Henry Co, Alabama" by Mrs M. Scott
- 45 Huff-Callan family history book
- 46 "The Callen Connection" by Rodney H Kirkpatrick
- 47 "The Kennedy Line" by Rodney Kirkpatrick
- 48 "Three Generations of Valentine Kirkpatrick" by W Doug Kirkpatrick
- 49 "Pioneers West of Appalachia" 1976 Jane Parker McManus

WILLIAM/ JOHN

- 50A Research by Doris Nelson
- B Research by Linda Barnes
- C Research by James M Gilmer, Jr(d)
- D Research by Carolyn (Glass) Warren
- E Research by Margaret Strauss
- F Information supplied by Ruby Ball
- G Information supplied by Beverly Eversull
- H Information supplied by Anne F Knight
- I Information supplied by Billy H Parker
- J Information supplied by Pearl Kirkpatrick Henderson

WILLIAM/ WILLIAM JR

- 51A Research by Carmack Waterhouse
- B Information supplied by Mary K (Callan) Nigh
- 52 "History of Yell County" Arkansas by Wayne Banks

WILLIAM/ JAMES

- 53 "Lumber River Scots and Their Descendants" The McLeans, Purcells, McIntyres, Torreys, Gilchrists 1942
- 54 "History of Methodism in Alabama and West Florida" by Marion Elian Lazernby 1960
- 55A Research by Col Wood Roe Purcell(d)
- B Information supplied by Carol (Purcell) Stevens
- C Information supplied by Douglas Clare Purcell
- D Information supplied by Norma Slayton
- E Information supplied by Mrs. E.A. Culverhouse
- F Information supplied by Jimmie Onita Adair

- 55G Information supplied by Mrs. Elsie P Tucker
- H Information supplied by Jerry Smith

WILLIAM/ THOMAS

- 56 Mecklenburg Co, N.C. courthouse records
- 57 Cabarrus Co, N.C. courthouse records
- 58 "Johnston County History" Oklahoma 1855-1979
- 59 "History of Johnston County, Oklahoma" compiled by Johnston County History Book Committee 1988
- 60A Research by William Morrow
 - B "Callen Family History" by Bob Graham 1981
 - C Information supplied by Ned Given
 - D Information supplied by Jerry Ray Callen
 - E Information supplied by Wilbur Dean Callen
 - F Information supplied by Roscoe M Callen
 - G Information supplied by Lamoin C; Wanda; Wilma; and Norma Callen
 - H Information supplied by Casto M Callen
 - I Information supplied by Leo L Callen

LINE OF CHARLES CALLEN

- 61 "A Biographical and Genealogical History of Southeastern Nebraska" Vol I The Lewis Publishing Company 1904
- 62 York Co, Penna courthouse records
- 63 Knox Co, Tennessee marriage records
- 64A Information supplied by Dorothy F (Clark) McConahay
 - B Information supplied by James Blaine Callen
 - C Information supplied by Opal Callen
 - D Information supplied by Dale Randall Callen
 - E Information supplied by Vergie (Putnam) Callen
 - F Information supplied by Eugene J Callen
 - G Information supplied by Audry Callen
 - H Information supplied by Janet Marie Callen
 - I Information supplied by Clifford W Callen

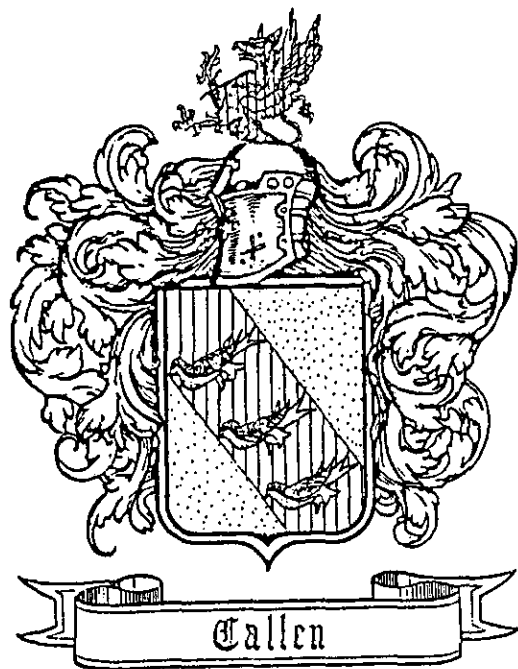

INDEX

Figures Refer to Descendant's Code Number - Not Page

1 = Line of Patrick

2 = Line of Samuel Sr

3 = Line of William Sr

4 = Line of Charles

ABERNATHY, Alice J (PAUL)	3,357	ALLEN, George Michael----	1,156
Andrew-----	3,358	Halley G CALLEN-----	3,109
Elsie (SANDER)-----	3,269	James-----	3,384
Eugene Sander-----	3,358	Kathy Jean REECE-----	1,156
Eugene Sander, Jr-----	3,358	Louise CRYTZER-----	1,95
John Daniel-----	3,180	Lucille M (CALLEN)-----	1,156
John Daniel, Jr-----	3,269	Maurice Isaac-----	1,156
John Daniel III-----	3,357	Peggy-----	1,225
John Daniel IV-----	3,357	Robert Brandon-----	3,384
Laura Lee (FARIS)-----	3,269	Thomas-----	1,232
Linda (TRITT)-----	3,358	ALLISON, Frances (CALLAN) II	3,98
Martha Gay (HARVEY)----	3,357	Martin Dillar-----	1,160
Mildred Callen RIDGEY--	3,268	Nolen-----	3,98
Selma (PURCELL)-----	3,180	Velma A (CALLEN)-----	1,160
Steven Harvey-----	3,357	ALUMS, Callie (CALLEN)---	3,79
Thomas Purcell-----	3,269	George C-----	3,79
William Charles-----	3,358	AMBROS, Mary E CALLEN----	3,59
ABLE, Augusta-----	1,14	AMES, Charles N-----	1,240
Mary A (CALLEN)-----	1,14	Karen Leah-----	1,240
ADAIR, Fritz Alford-----	3,281	Lisa Marie-----	1,240
Fritz Alford Jr-----	3,281	Lori Ann-----	1,240
Gladys E (HARRISON)----	3,281	Mary Catherine (CALLEN)	1,240
Gladys Loretta-----	3,281	Rhonda K-----	1,240
Jimmie Onita-----	3,372	AMICK, Vera P CALLEN-----	3,204
Mary Juanita-----	3,281	AMIS, Stella GLASS-----	3,171
ADAMS, Daina PRESLEY----	3,245	AMMONS, Audrey B CALLEN--	4,63
Doris CALLEN-----	3,303	Fern (MILLER)-----	4,63
Jennie (CALLEN)-----	3,42	Fred D-----	4,63
AGGAS, Almira THOMPSON---	1,58	ANDERSON, Alfred-----	1,173
AHARRAH, Catherine (ELROD)	1,50	Alice Mary COCHRAN-----	1,104
Ella WOLFORD/CALLEN----	1,50	Caroline CALLEN-----	1,250
Margaret L CALLEN-----	1,50	Charles-----	1,173
William-----	1,43	Connie Agnes (PICKENS)-	3,154
AIRHART, Juniata SHAW----	1,210	Edward-----	1,173
AKINS, Brenda Lea CALLEN-	2,64	Gladys (KELLOG)-----	1,173
John Martin-----	1,254	Ida A (BELDING)-----	1,104
Ruth Elaine (CALLEN)---	1,254	John A-----	1,104
ALBERTSON, Asenath (CALLEN)	4,24	Louise Isabelle-----	1,104
George J-----	4,22	Mary (CALLEN)-----	1,58
Nancy (JONES)-----	4,22	Nell-----	3,154
Rebecca Pharaby CALLEN-	4,22	Richard-----	1,173
ALBRIGHT, Hazel (CALLEN)-	1,154	ANDREWS, Cordelia (CALLEN)	4,8
Milton Monroe-----	1,154	ANTHONY, Daisy CHAMBERS--	3,256
Winifred Claire SOUZA--	1,223	ANTILLEY, Aubrey Allen---	3,329
ALEXANDER, Sarah Callen--	3,4	Bertha N (WILLIAMSON)--	3,230
ALLEN, Chery Ann (CALLEN)	3,384	Betty C (WEST)-----	3,328
Ellen (LIVENGOOD)-----	1,232	Bobbie Faye HOLLINGER--	3,327
Elton James-----	3,384	Deborah Lynn-----	3,328
George-----	1,232	Delores (CASTILLE)-----	3,329
		Gary Allen-----	3,329

ANTILLEY, James Franklin- 3,230
 Jimmy Dain----- 3,328
 Mark Wade----- 3,328
 Rudolph----- 3,328
 ARGO, Susan Jane CALLEN-- 4,21
 ARMSTRONG, Mary E CALLEN- 4,16
 ARNOLD, Lillie DENNIS---- 3,226
 ASHMORE, Carry KIRKPATRICK 3,140
 ASHWORTH, Adaline NELSON- 3,318
 ATHERTON, George W----- 2,39
 Mary E (CALLEN)----- 2,39
 AUSTIN, Kimberly Lynn---- 1,220
 Patricia (CALLEN)----- 1,220
 Raymond Scott----- 1,220
 Raymond L----- 1,220
 AVANT, Dorothy CALLEN---- 1,79
 AVERYT, Edith L PERRY---- 3,189
 Francis (MARTIN)----- 3,52
 "Nellie" T (READ)----- 3,92
 Thomas Daniel----- 3,92
 Thomas Henry----- 3,52
 AYERS, Sarah C CALLEN---- 3,22

 BACKENSTOCE, Faye (CALLEN) 1,103
 O.J.----- 1,103
 BAGLEY, Charlie----- 4,9
 BAILEY, Arlene (KRIEBEL)- 1,264
 Deborah S (CALLEN)----- 1,264
 Jeanne E CALLEN----- 2,61
 Lisa Camille----- 1,264
 Melissa Suzzanne----- 1,264
 Paul William----- 1,264
 William Gabriel----- 1,264
 William James Jr----- 1,264
 William James Sr----- 1,264
 BAKER, Curtis H----- 1,192
 Danny Lee----- 1,192
 David Michael----- 1,271
 Dianna Lynn----- 1,192
 Hannah Marie----- 1,271
 Herman Curtis----- 2,44
 Jason Matthew----- 1,271
 Josephine (CALLEN)----- 1,192
 Leslie Eugene----- 2,44
 Mary Patricia (CALLEN)- 1,271
 Phillip Michael----- 1,271
 Sarah Ellen CALLEN----- 2,15
 Vada L (CALLEN)----- 2,44
 BALDWIN, Opal S CALLEN--- 4,33
 BALL, Clarence----- 3,314
 Ruby M BROWN----- 3,314
 BALLARD, Candice SIMMONS- 1,278
 Nellie CHAMBERS----- 3,257
 BALLENGER, David George-- 1,273
 Kate Alise----- 1,189

BALLENGER, Kathleen NUNN- 1,290
 Kara Kristine----- 1,189
 Keith----- 1,289
 Kevin----- 1,291
 Kristine (SMITH)----- 1,189
 Win (SOUZA)----- 1,273
 BALOG, Christine SIMMONS- 1,278
 BARNARD, Betty CALLEN---- 1,205
 BARGANIER, Bishop----- 3,80
 Elizabeth (CALLEN)----- 3,80
 Nancy Hulda WOOD----- 3,67
 BARNES, Billy Buford---- 3,264
 Craig Allan----- 3,264
 Harriet "Linda"(GRIZZLE) 3,264
 Malinda Kay----- 3,264
 BARTON, Christena (CALLEN) 2,57
 George Dewey----- 2,57
 Rebecca Lynn----- 2,57
 BASHLINE, Blanche SILVES- 1,132
 David Hunter----- 1,65
 Mary Eliza Jane(CALLEN) 1,65
 BATES, Louisa T CALLEN--- 1,44
 BAUGHER, Alissa Denise--- 4,73
 Betty J (CALLEN)----- 4,59
 Brent Allen----- 4,73
 Carrol DeWayne----- 4,73
 Daniel Clayton----- 4,73
 Eric Nathan----- 4,73
 Gary Eugene----- 4,74
 Judson Leonard----- 4,59
 Karol (PIERCE)----- 4,73
 Marsha (CHRISMAN)----- 4,73
 Shawn Allen----- 4,74
 BAUM, Clare P (SMITH)--- 3,278
 Walter Gibbs----- 3,278
 BAYNE, Katie CULVERHOUSE- 3,279
 BEAR, Maurine E CALLEN--- 1,157
 BEAVERS, Arthur----- 3,112
 Effie (CALLEN) RUTH---- 3,112
 Joann (CALLAN)----- 3,99
 R.N.----- 3,99
 BEERBOWER, Thelma CALLEN- 4,82
 BELDING, Alice (McLAUGHLIN) 1,108
 Anna Ida----- 1,109
 Augusta FLEMING----- 1,105
 Charles----- 1,109
 Elmer----- 1,46
 Ida A ANDERSON----- 1,104
 June----- 1,108
 Mary Catherine----- 1,107
 Mary Louise----- 1,109
 Mary Luceta (CALLEN)--- 1,46
 Mary Mildred (BROWNING) 1,109
 Nelle Latimer (SHAW)--- 1,107
 Nelle SPURRIER----- 1,106
 Oscar Milton----- 1,108

BELDING, Ralph Walter----	1,109	BIRD, Callen Sterling----	1,89
Sara Raephine-----	1,109	Caroline B COLLINS-----	1,167
Therou Elmer-----	1,107	Clyde Clifton-----	1,92
Thomas-----	1,109	Constance D (BROWN)----	1,167
BELL, Julia GLASS-----	3,158	Dorothy C (CROMLEY)----	1,92
BENNET, Letha DENNIS----	3,317	Edgar Victor-----	1,92
BENNETT, Alfred-----	1,198	Elisha-----	1,37
Armstrong-----	3,225	Eva Bessie (ROSENCRANCE)1,92	
C Belle WILLIAMSON----	3,225	Evelyn J (STUTZMAN)----	1,167
Elsie Marie (MYERS)----	1,198	Francis Asbury-----	1,37
Floyd-----	3,222	George Arlington-----	1,91
Kenneth-----	3,222	Georgia-----	1,91
Marjorie CALLEN-----	1,198	Harry Ray-----	1,93
Martha E (JACKSON)----	3,225	Hubert-----	1,91
Martha (HICKS)-----	3,227	John Francis-----	1,167
Molly Walter CALLEN----	3,57	John William-----	1,167
Ruby Lee PARKER-PREWETT	3,315	Lillian (TEETERS)-----	1,91
R.V. "Andy"-----	3,222	Louis-----	1,91
Sarah "Sally" (BROWN)--	3,222	Mary SEABERT-----	1,37
BENTLEY, Shirley R CALLEN	1,217	Mary L MCKELVEY-HUMPHREYS	1,90
BERKHEAD, Hoyl D-----	3,102	Maude (MOHNEY)-----	1,89
Thelma (CALLAN)-----	3,102	Muriel R HOLBEN-----	1,167
BERLIN Charles R-----	1,200	Neil-----	1,91
Della Y (CALLEN)-----	1,200	Orin Wakefield-----	1,37
Tina Hope PRUNTY-----	1,268	Rebecca (SHARP)-----	1,37
BERRY, Alice WALTERS----	3,355	Sarah Yvonne DOWLING---	1,92
Claire Purcell-----	3,371	Victor Reynolds-----	1,167
Douglas-----	3,371	BISHOP, Jean A CALLEN----	2,56
Hamilton Douglas-----	3,371	Joyce PURCELL-----	3,275
Ray H (SMITH)-----	3,371	Rebecca L NIGH-----	3,378
BERTRAM, Caroline (KIRKPATRICK)	3,216	BIVENS, Dorothy SIMMONS--	1,238
Robert-----	3,216	Eva Mae CALLEN-----	2,43
Robert Patrick-----	3,216	BLACK, Helen CALLEN-----	4,56
Rodney Harris-----	3,216	BLACKWELL, Jennie (TOLBERT)	3,121
BETTS, Minnie M GLASS----	3,172	Mary (KIRKPATRICK)-----	3,61
BETZ, Laura CALLEN-----	1,69	BLANCHARD, Marie (WATTENBARGER)	4,34
BIBBS, Mary E (SLAYTON)--	3,188	BLANKENSHIP, Betty CALLEN	3,210
BIGGERS, Birdie-----	3,103	BOLEY, Angela-----	3,353
Calvin-----	3,103	F Ray-----	3,353
Cass-----	3,103	Kay A (KNIGHT)-----	3,353
Catherine (CALLEN)-----	3,55	Robert-----	3,353
Denver-----	3,103	BOOFER, Dorothy (CALLEN)-	1,249
Ellwood-----	3,103	John David-----	1,249
Frederick-----	3,103	Michael David-----	1,249
George B-----	3,103	BOOK, Hattie THOMPSON----	1,127
Gorda CALLAN-----	3,99-3,196	BORDGES, Andrew Steven---	1,274
James H-----	3,55	Ashley Marie-----	1,274
John-----	3,103	Christina-----	1,274
Maggie-----	3,103	Jason-----	1,274
NORMA-----	3,103	Susan Marie (CALLEN)---	1,274
Willam-----	3,103	BOVARD, Frances CHAMBERS-	2,4
Willie A (HUFF)-----	3,103	BOWDISH, Cornelia (BRUNSON)	1,36
BILL, Mary KIRKPATRICK---	3,27	Elizabeth CALLEN-----	1,118
BIRD, Adah-----	1,93	Philo-----	1,36
Anna Sarah (CALLEN)----	1,37	Sarah Margaret-----	1,36
Bertha J HUMPHREYS-----	1,88	BOWEN, Evelyn Nesbett---	3,142

BOWEN, Inee (HORNADAY)--- 3,142
 W.L.----- 3,142
 BOWERSOX, Joan K CALLEN-- 1,242
 BOYD, Jane----- 1,18
 Margaret----- 1,18
 Mary CALLEN----- 3,21
 Minnie KIRKPATRICK----- 3,136
 Patricia Lee CALLEN----- 3,212
 Robert----- 1,18
 BRADFORD, Charlene (WILLIAMSON) 3,324
 Jerrell Earnest----- 3,324
 Judy Marie----- 3,324
 Lee Edward----- 3,324
 "Sallie" (WILLIAMSON)-- 3,324
 Troy Lynn----- 3,324
 BRADLEY, James----- 3,362
 Jonathan Dalton----- 3,362
 Mildred E (COLLINS)---- 3,362
 William Meredith----- 3,362
 BRANDON, Elliot----- 1,7
 Mary (RAYBURN)----- 1,4
 Sarah (CALLEN)----- 1,7
 BRAY, David H----- 3,100
 Ethel CALLAN----- 3,100
 Lillie (KERSEY)----- 3,100
 BREEDLOVE, Jean----- 2,29
 BREWER, Burnice SULLIVAN- 3,292
 BRIANT, Emeline (CALLEN)- 4,12
 William J----- 4,12
 BRIDENALL, Louise KIRKPATRICK 3,237
 BRIDGES, Londa (SLAYTON)- 3,373
 BRISLIN, Florence CALLEN- 1,152
 BRITTAN, Gail COLLINS---- 3,360
 BROCKWAY, Elizabeth (CALLEN) 1,40
 Wakefield----- 1,40
 BROHAMER, Josephine CALLEN 1,87
 BRONTE, Charlotte CALLEN- 1,116
 BRONSON, Irene I CALLEN-- 1,178
 BROOKS, Jessie B CALLEN-- 1,49
 BROSI, Mary (DICKEY)---- 2,5
 BROTHERS, Esther CALLEN-- 1,169
 BROWN, Almira (CALLEN)--- 1,62
 Constance D BIRD----- 1,167
 Cynthia C CALLEN----- 4,26
 Dalton----- 3,223
 Eddie----- 3,382
 Ellen Virginia GLASS--- 3,253
 Florence CALLEN----- 4,22
 Gordon----- 3,287
 Henry Thornton----- 3,129
 Jeanine----- 3,375
 Jennifer----- 3,375
 John Samuel----- 3,220
 Josinell GILES----- 3,223
 Kay (COURTNEY)----- 3,382
 Lillie (MONK)----- 3,223

BROWN, Mary A (TINSLEY)-- 3,129
 Mary S (FUNDERBURK)---- 3,220
 Melba NEVILLE----- 3,223
 Michael----- 3,375
 Michelle Rhodes----- 3,375
 Nancy A (CALLAN)----- 3,287
 Patricia E (CALLAN)---- 3,375
 Patrick H----- 3,221
 Ruby Mae CRAWFORD-BALL- 3,314
 Sarah Ann (SIMS)----- 3,129
 Sarah BENNETT-JACKSON-- 3,222
 William Thornton----- 3,129
 William Thornton----- 3,223
 William Thornton Jr---- 3,223
 Winsor W----- 1,62
 BROWNING, Alice CALLEN--- 4,53
 Corrine KIRKPATRICK---- 3,235
 Mary Mildred BELDING--- 1,109
 BROSKI, Mary (DICKEY)---- 2,5
 BRUMBAUGH, Blanche CALLEN 1,78
 BRUNNER, Deborah A NIGH-- 3,379
 BRUNSON, Cornelia (BOWDISH) 1,36
 BRYAN, Sethy CALLEN----- 4,7
 BRYANT, Cecelia (CALLEN)- 1,187
 James----- 1,187
 BUCCIGROSSI, August----- 1,131
 Bonnie Jean----- 1,202
 Charles David----- 1,202
 Enrico Charles----- 1,202
 Hazel (CALLEN)----- 1,131
 Jason Alexander----- 1,202
 Lora (St JOHN)----- 1,202
 Rita----- 1,202
 Robert C----- 1,202
 BUCKHORN, Maude Campbell- 2,30
 BUCKNER, Bessie K EVERSULL 3,219
 BURK, Lottie CALLEN----- 4,57
 BURNEY, Katrina G (YORK)- 3,207
 BUNTING, Crystal (COURTNEY) 3,381
 Dan----- 3,381
 Dan Lynn----- 3,381
 Dustan----- 3,381
 BURHAM, Linda K CALLEN--- 2,63
 BURROW, Jimmie O (ADAIR)- 3,372
 Patience Dean----- 3,372
 Patrick Lynn----- 3,372
 Paul Gaylor----- 3,372
 Roy Dean----- 3,372
 BUSCHMAN, A.H.----- 2,18
 Josephine (CALLEN)---- 2,18
 Lewis C.----- 2,18
 Lula May----- 2,18
 BUTLER, Amanda Claire--- 3,401
 Barbara G (EZELL)----- 3,401
 Callen Elizabeth----- 3,401
 Charles Paul III----- 3,401

CADE, Mildred COLLINS---- 3,273
 CAIN, Betty (FLEMMING)--- 1,134
 Donald Muir----- 1,134
 CALBREATH, Mary----- 1,1
 CALDWELL, Colleen(TOWNSEND) 1,197
 CALHOUN, Donna LAWLEY---- 3,302
 James----- 1,144
 Marlene (WOODS)----- 1,144
 CALIN, William----- 3,1
 CALLAHAN, Mary McNELLIS-- 1,146
 CALLAIN, William----- pg 13
 CALLAN, A.W.----- 3,193
 Alfred----- 3,102
 Allie Willis (1894)---- 3,190
 Allie Willis Jr----- 3,284
 Amanda Alice PILQUIST-- 3,94
 Amy----- 3,286
 Aslee (TILLMAN)----- 3,96
 Audie Matilda----- 3,53
 Billie B (LANHAM)----- 3,193
 Caroline Donnis JONES-- 3,95
 Carolyn----- 3,98
 Cindy----- 3,286
 Clemmie Price CLINTON-- 3,98
 Dollma J IRWIN----- 3,99
 Donald P, Dr----- 3,193
 Dorcas "Orlean" McCRAY- 3,101
 Edward (Rev War)----- pg 12
 Elizabeth A INGLING---- 3,193
 Elizabeth ELLISON----- 3,98
 Emily S (HENDRICKS)---- 3,284
 Ester (SNOW)----- 3,193
 Ethel (BRAY)----- 3,100
 Eunice E (HARMAN)----- 3,190
 Everett D----- 3,192
 Everett D II----- 3,286
 Everett D III----- 3,286
 Frances II ALLISON----- 3,98
 Frances Narcis GRAY---- 3,97
 Frances STOVALL----- 3,99
 George Monroe II----- 3,93
 Gorda (BIGGERS)----- 3,99-3,196
 "Gus" Leonard----- 3,102
 Harrison Alexander--- 3,99-3,196
 Hobart Monroe----- 3,191
 Irma----- 3,100
 James (1773-Rev War)--- pg 9
 James Burton----- 3,100
 Janis L VESTAL----- 3,377
 Joann BEAVERS----- 3,99
 Kate (LEEPER)----- 3,93
 Katherine A (KERSEY)--- 3,93
 L.D.----- 3,99
 Lavanche (LEMOYNE)---- 3,102
 Leonard II----- 3,102
 Leonard "Gus"----- 3,102

CALLAN, Linda HENDERSHOTT 3,374
 Lisa----- 3,286
 Margaret MILLER----- 3,102
 Marie----- 3,96
 Mary Katherine NIGH---- 3,285
 Melba (KETTEN)----- 3,286
 Mildred----- 3,96
 Nancy A COURTNEY-BROWN- 3,287
 Nancy (HUFF)----- 3,46
 Nancy (SCHULMAR)----- 3,193
 Neva (HANES)----- 3,191
 Olen----- 3,96
 Orlean McCRAY----- 3,101
 Patrick----- pg 11,12
 Patricia E BROWN----- 3,375
 Pete G----- 3,99
 Rebecca S LARGE----- 3,376
 Ronald W----- 3,193
 Rosa (PIGEON)----- 3,99
 Ruby (CLINTON)----- 3,98
 Thea----- 3,286
 Thelma BERKHEAD----- 3,102
 Vivian (WADSWORTH)---- 3,193
 William----- pg 12
 William Anderson----- 3,96
 Zanthia (LEMOYNE)----- 3,192
 CALLAND, John----- 3,2
 William----- 3,1
 CALLANS, John----- 3,2
 William----- pg 10-3,1
 CALLEN, Ada----- 1,64
 Ada Lorain GILMER----- 3,82
 Ada Lorain STARK----- 3,40
 Ada (McELWAIN)----- 3,48
 Adalaid----- 2,12
 Adaline E CHAMBERS---- 4,13
 Adaline (MOHNEY)----- 1,35
 Adie----- 1,77
 "Agnes" (KERR)----- 3,2
 Alabama----- 3,12
 Albert----- 4,9
 Albert Henry----- 4,14
 Albert Sherman----- 4,24
 Alberta----- 3,109
 Aletha Merle----- 4,31
 Alexander----- pg 11
 Alice A (PILQUIST)---- 3,94
 Alice Brockway----- 1,39
 Alice (COWGILL)----- 4,1
 Alice Jane (BROWNING)-- 4,53
 Alma D HOLMS-CUNNINGHAM 4 42
 Almira BROWN----- 1,62
 Alpheus----- 1,50
 Alva Barrett----- 1,48
 Alvie----- 3,200
 Alvin Cummings----- 1,36

CALLEN, Alvin Cummings III 1,162
 Alvin Emmett----- 4,20
 Amanda----- 2,4
 Amanda CONWAY----- 3,75
 Amanda J RHINES----- 1,38
 Amanda Minerva----- 3,8
 Amarantha (ESPY)----- 1,129
 Amber Laurea----- 1,266
 Americus Napoleon----- 3,21
 Americus Vespusus----- 3,21
 Amy Deloris (TUCKER)--- 3,115
 Amytus PHIELPS----- 1,51
 Anderson Douglas----- 4,11
 Anderson E----- 4,9
 Andreas----- pg 12
 Andrew----- 4,19
 Andrew J----- 3,19
 Andrew White----- 1,16
 Angie (CHANNEY)----- 3,108
 Anita Mae (HENLEY)---- 4,58
 Ann----- 1,1
 Ann Clementine----- 3,7
 Ann (MILLER)----- 2,1
 Anna B (1861)----- 1,22
 Anna Jane----- 1,76
 Anna Juanita (HART)---- 3,199
 Anna Marie----- 2,2
 Anna Marie (KILEY)---- 1,195
 Anna (McGANN)----- 1,117
 Anna MARTIN----- 3,16
 Anna MORRISON----- 3,30
 Anna R "Annie" SHENK--- 2,20
 Anne Elizabeth PRICE--- 1,272
 Annie Hall COLE----- 3,37
 Annie Ester (DODSON)--- 1,75
 Annie (HATE)----- 2,17
 Annie (KING)----- 1,67
 Annie E (MARSHALL)---- 3,38
 Annie (MILLER)----- 2,49
 Annis WAKEFIELD----- 4,6
 Antonio Jose----- 1,250
 April Geni----- 1,244
 Archibald----- 4,3
 Archibald Roane----- 3,81
 Ardis Hope WALTER----- 4,51
 Arlene (COOLEY)----- 1,227
 Arminta Arzula----- 1,71
 Artie (CLINE)----- 4,45
 Arthur Alexander----- 1,82
 Arthur Burl----- 1,190
 Arthur Fleming----- 1,24
 Arthur Fleming----- 1,117
 Arthur H----- 1,60-1,74
 Arthur Lynn----- 1,54
 Arthur Roscoe----- 1,100
 Arzrow----- 3,109

CALLEN, Asenath (ALBERTSON) 4,24
 Ashley Marie----- 4,77
 Ashley Renee----- 1,266
 Ashley Renee----- 4,72
 Audra G WIDNER----- 4,41
 Audrey B (AMMONS)----- 4,63
 Audrey Ellen WOODCOCK-- 4,22
 Augustus----- 3,59
 Augustus Gideon----- 3,22
 Augustus Gideon Jr----- 3,22
 CALLEN, Barbara Ann----- 1,178
 Barbara J (SALLEE)----- 1,185
 Barbara J (VAN ORNUM)--- 3,205
 Barbara Jean (WALTON)--- 1,177
 Barbara LATHROP----- 1,162
 Barbara Lea LaFOND----- 1,241
 Barry Lee----- 1,227
 Beatrice L THEIN----- 1,248
 Benjamin Albert----- 4,20
 Benji----- 4,71
 Bertha (1898)----- 1,63
 Bertha E (THOMPSON)--- 1,58
 Bertha Lorraine SHAW--- 1,135
 Bessie----- 3,42
 Bessie Belle LEAL----- 1,182
 Bessie (GOLSON)----- 3,39
 Bessie (HENRY)----- 1,70
 Beth Elaine----- 1,246
 Beth Margene MILLIKAN-- 1,186
 Betty----- 1,73
 Betty D (BLANKINSHIP)--- 3,210
 Betty NICHOLS----- 1,218
 "Betty" Frances JONES-- 1,129
 Betty Jean BAUGHER----- 4,59
 Betty Lou (SAMPLES)---- 1,190
 Betty Marie (BARNARD)--- 1,205
 "Betty" GILLIGAN----- 1,191
 Beulah F (CAMPBELL)--- 2,30
 Beverly (HEDLRAND)---- 4,81
 Beverly J (MEEKINS)---- 1,245
 Birdie----- 1,32
 Blake Michael----- 4,75
 Blanch F (BRUMBAUGH)--- 1,78
 Blanch STAHLMAN-ROSS--- 1,55
 Blanche Elaine PETERS-- 3,117
 Blanche Irene----- 3,59
 Blanche M (JENKIN)---- 2,28
 Bobbie Donald----- 2,32
 Bonnie (DILLON)----- 1,219
 Bonnie Jean (SALLEE)--- 1,185
 Bonnie Lou----- 1,158
 Brad----- 1,165
 Bradley Raymond----- 2,63
 Brandi Lynn----- 3,310
 Brenda----- 1,178
 Brenda Lea (AKINS)---- 2,64

CALLEN, Brenda Louise---- 1,217
 Brooke Arden----- 3,310
 Bruce Allen----- 1,244
 Bruce Michael----- 4,68
 Buenos Ayers----- 3,59
 Buenos Marion----- 3,59
 Bulah RUBLE----- 1,122
 Bulcena Ida----- 3,21
 Burl Arthur----- 1,123
 Burton Rudolph----- 3,59
 CALLEN, C.J.----- 1,22
 Callie----- 3,54
 Callie ALUMS----- 3,79
 Callie Marie----- 3,311
 Calvin?----- 4,3
 Calvin Whiting----- 4,10
 Candace C DALEEP----- 1,181
 Candice Aubrey----- 3,310
 Carl Vincent----- 3,211
 Carl William----- 4,31
 Carla Mae----- 3,211
 Carnel Lesley----- 3,206
 Carol Ann STEWART----- 1,255
 Carol Janice----- 1,284
 Carol Joyce----- 4,56
 Caroline (ANDERSON)----- 1,250
 Caroline HAYS----- 4,17
 Caroline M MCKOWN----- 2,9
 Caroline O'DENBAUGH----- 1,62
 Carolyn Ann (WILLIAMSON) 3,383
 Caron (TEACHMAN)----- 1,178
 Carrie A KERRY----- 1,36
 Carrie C (NELSON)----- 2,31
 Carrie Jane (LINDSEY)--- 4,18
 Carrol Wayne----- 4,37
 Cassandra UNDERWOOD--- 4,5
 Casto Mervin----- 3,204
 Cater----- 3,42
 Catherine (1800)----- 3,13
 Catherine A BIGGERS----- 3,55
 Catherine E (KERR)----- 1,188
 Catherine (GRIEF)----- 1,22
 Catherine (LUDKE)----- 2,32
 Catherine Marie----- 1,281
 Cecelia BRYANT-SIMMONS- 1,187
 Charles (1783)----- 4,1
 Charles (179?)----- 4,7
 Charles (1872)----- 1,24
 Charles (Cal)----- 2,44
 Charles Brunson----- 1,84
 Charles Douglas----- 4,53
 Charles Emett III----- 4,32
 Charles Freeman----- 1,152
 Charles Herman----- 1,60-1,74
 Charles Hugh----- 1,130
 Charles Josiah----- 1,127

CALLEN, Charles Josiah(1951) 1,259
 Charles Kenneth----- 2,62
 Charles Lee----- 1,246
 Charles Montgomery----- 4,11
 Charles T (1875)----- 1,50
 Charles T (1871)----- 1,64
 Charles Thomas----- 1,64
 Charles W----- 1,22
 Charlie----- 4,10
 Charlotte (BRONTE)----- 1,116
 Charlotte (VanARSDALE)- 1,158
 Chelsea Brooke----- 3,383
 Cheri Lynn DYE----- 1,257
 Cheryl A ALLEN-LYMAN--- 3,384
 Cheryl Diane----- 3,307
 Chester----- 1,96
 Chester G----- 1,52
 Chester Gleavie----- 2,48
 Chestina (SMITH)----- 3,202
 Chris Doyle----- 1,157
 Christa Lee----- 1,221
 Christena Mae BARTON--- 2,57
 Christine----- 4,9
 Christopher----- 3,59
 Christopher Sylvester-- 4,23
 Cicero----- 3,54
 Clara CARGILL----- 3,114
 Clara E----- 2,6
 Clara SPEARS----- 4,44
 Clarence Edward "Jake"- 3,106
 Clarence Walter----- 4,35
 Clarinda UNDERWOOD--- 4,5
 Clarissa STAHLMAN-ROSS- 1,55
 Clarissa L (SMITH)----- 1,31
 Claude Alva----- 3,58
 Claude C----- 1,110
 Clayton----- 3,202
 Clayton Jr----- 3,303
 Cleo Earline----- 4,38
 Cleo Paul----- 1,115
 Cleone Frances----- 1,78
 Clifford----- 1,96
 Clifford Ray----- 3,308
 Clifford Windell----- 4,58
 Clint William----- 3,308
 Clinton Woodrow----- 3,197
 Clyde----- 1,163
 Clyde----- 4,27
 Clyde Bartlett----- 1,86
 Clyde Francis----- 4,62
 Clyde Wayne----- 1,261
 Codi Catherine----- 1,236
 Cody Leslie----- 2,45
 Columbus----- 3,20
 Columbus----- 3,54
 Columbus Adolphus----- 3,21

CALLEN, Conon----- 1,165
 Cora (WENDT)----- 1,114
 Corbin----- 1,165
 Cordelia ANDREWS----- 4,8
 Cordilia (WARD)----- 2,14
 Courtney Gail----- 2,65
 Coy Crat----- 3,111
 Craig Charles----- 1,226
 Craig R----- 1,163
 Craig Randall----- 4,68
 Crat Thomas----- 3,58
 Creath Harold----- 4,52
 Crystal----- 4,47
 Crystal Ann----- 3,383
 Curtis Edward----- 1,67
 Cynthia (BROWN)----- 4,26
 Cynthia June KERNS----- 1,22
 Cynthia Nicole----- 1,269
 CALLEN, Dale----- 2,26
 Dale----- 3,297
 Dale C----- 3,204
 Dale Emerson----- 3,211
 Dale Randall----- 4,68
 Dale Walter----- 1,261
 Dale Walter Jr----- 1,261
 Daniel Lee----- 3,211
 Daniel Roy----- 1,253
 Danny Bob----- 1,184
 Danny D----- 1,235
 Darl Henry----- 1,145
 Darl Henry Jr----- 1,145
 Darlene Bertha JONES--- 1,251
 David----- 1,84
 David----- 1,162
 David (1792)----- 1,8
 David (1803)----- 1,12
 David (1846)----- 1,17
 David Dewitt----- 1,49
 David Dewitt Clinton--- 1,44
 David Frederick----- 4,81
 David Hartley----- 1,52
 David O----- 1,63
 David Patrick----- 1,117
 David R----- 1,14
 Dawn Renee----- 1,246
 Dayla----- 3,297
 Dean----- 1,140
 Deana Sue----- 2,56
 Debbie E----- 1,52
 Debbie HOLLINGSWORTH--- 4,81
 Debbie (McCAFERY)----- 1,236
 Debora Suzanne BAILEY- 1,264
 Deborah A (DUSTIN)----- 1,270
 Deborah Christine----- 1,217
 Deborah McGOWN-WHITNEY- 4,76
 Debra Elaine----- 3,307

CALLEN, Delbert R "Bob"-- 1,184
 Dell----- 1,23
 Della June LILES----- 3,115
 Della Yvonne BERLIN---- 1,200
 Della THOMPSON----- 1,124
 Deloris (SWINEHART)---- 1,285
 DeMaris (EBERHART)---- 1,206
 Dewain M----- 3,204
 Diana Kay----- 1,184
 Diana M (SMITH)----- 3,46
 Diane (LEHMAN)----- 1,246
 Diane Marie----- 1,172
 "Diddo" Henry----- 4,2
 Dolphy Ralph----- 3,117
 Don----- 1,215
 Donald Dewitt----- 1,177
 Donald Duane----- 4,61
 Donald Hugh----- 1,136
 Donald Rickard Jr----- 1,222
 Donald Rickard Sr----- 1,151
 Donella Marie (ELWELL)- 1,261
 Donnia (GRAY)----- 4,70
 Donnie Lee----- 4,55
 Dora----- 3,20
 Dora Etta SNEED----- 3,105
 Dorcas HOOKS----- 3,10
 Doris----- 4,47
 Doris (ADAMS)----- 3,303
 Doris Irene MACKEY----- 1,169
 Doris (JEWELL)----- 1,162
 Doris June TAYSEN----- 2,42
 Doris (KERLE)----- 1,221
 Doris M (THOMPSON)---- 1,260
 Dorothy----- 1,73
 Dorothy B HINMAN-LAIRD- 2,53
 Dorothy Grace BOOFER--- 1,249
 Dorothy Helen (MACKEY)- 1,196
 Dorothy Lee (AVANT)---- 1,79
 Dorothy May TOWNSEND--- 1,197
 Dorothy MCKINLEY----- 1,214
 Dorothy Nora----- 1,83
 Douglas Bradley----- 4,53
 Douglas Eugene----- 1,179
 Doyle Eugene----- 4,71
 CALLEN, Earl----- 1,46
 Earnest Lonnie----- 3,107
 Echo Deann----- 3,388
 Eden Rush----- 2,42
 Edgar----- 3,30
 Edith CARR----- 1,101
 Edith Grace WIDNER----- 4,39
 Edith H (MILLICAN)----- 3,107
 Edith Pearle WOODCOCK-- 4,22
 Edith (TOWNSEND)----- 4,47
 Edna----- 1,84
 Edna (YOUNG)----- 1,79

CALLEN, Edna B McNEIL---- 1,53
 Edna Daisy SWEET----- 1,98
 Edna Jean----- 1,100
 Edna Marie McNELLIS---- 1,247
 Edrie Garnet PHIPPIS-- 4,51
 Edward----- 1,73
 Edward (1737)----- pg 8
 Edward (1766)----- pg 2
 Edward (1799)----- 4,8
 Edward Dickey----- 2,23
 Edward Dickey (1939)--- 2,52
 Edward Dickey Jr----- 2,52
 Edward Ellsworth----- 1,113
 Edward Everett----- 1,83
 Edward Miller----- 2,30
 Edward R----- 4,15
 Edwin Lloyd----- 4,82
 Effie (1860)----- 1,21
 Effie Jane----- 3,21
 Effie Lena----- 3,58
 Effie RUTH-BEAVERS---- 3,112
 Effie WATTENBARGER---- 4,34
 Elana Delores----- 3,210
 Eldon Clifford----- 1,75
 Eldon Neil----- 4,57
 Eldon Rosco----- 4,38
 Eleanor----- 1,130
 Eleanor RAYBURN----- 1,4
 Elisha Jane----- 3,22
 Eliza Ann----- 4,2
 Eliza Ellen COULSEN---- 4,25
 Eliza Jane COTHRAN---- 3,32
 Eliza Jane MCKNIGHT---- 2,13
 Eliza Jane (NICHOLS)- 1,60-1,74
 Eliza Jane (TORRANCE)-- 2,6
 Eliza M----- 2,2
 Eliza W (LAUGHLIN)---- 1,14
 Elizabeth (1811)----- 1,15
 Elizabeth A BROCKWAY--- 1,40
 Elizabeth Ann----- 4,9
 Elizabeth BARGANIER---- 3,80
 Elizabeth (BOWDISH)---- 1,118
 Elizabeth (CULVERHOUSE) 3,18
 Elizabeth (FLEMING)---- 1,32
 Elizabeth (FOSTER)---- 3,7
 Elizabeth GEORGE----- 3,14
 Elizabeth H (KENNEDY)-- 3,11
 Elizabeth K COX----- 3,5
 Elizabeth KIRKPATRICK-- 3,6
 Elizabeth (KISKADDEN)-- 1,10
 Elizabeth (LEATHERS)--- 3,20
 Elizabeth (LITTLES)---- 2,41
 Elizabeth Matilda NALE- 1,199
 Elizabeth (MATTHEWS)--- 3,20
 Elizabeth MAUPINE----- 4,1
 Elizabeth A (MOUPINE)-- 4,10

CALLEN, Elizabeth SHAW--- 3,12
 Elizabeth (TAYLOR)-----pg 10-3,1
 Elizabeth (WALLACE)---- 3,17
 Ella----- 1,15
 Ella (AHARRAH) WOLFORD- 1,50
 Ella WENGER----- 1,63
 Ellen----- 2,43
 Ellen H JACKSON----- 3,41
 Ellen HASKELL----- 1,8
 Ellen (HIATT)----- 4,29
 Elliot Newton----- 1,45
 Ellis Callen----- 3,11
 Elma----- 1,73
 Elmer Ellsworth----- 3,59
 Elmira----- 2,12
 Elmo Hugh----- 1,72
 Elnora D (STOLLER)---- 1,224
 Elsie FISCUS----- 1,51
 Elsie Mae----- 4,26
 Elsie Marie----- 1,127
 Elsie Maud----- 1,96
 Elva (PETERSON)----- 1,141
 Elvira (JOHNSON)----- 3,54
 Elzadie (HILTFN)----- 4,7
 Emeley HUNTER----- 2,1
 Emeline Delany BRIANT-- 4,12
 Emeline S MCKNIGHT---- 2,8
 Emily----- 1,15
 Emily----- 3,354
 Emily V----- 2,6
 Emma S EDGELL-CARD---- 1,47
 "Emma" Cornman----- 1,55
 Emma V (CATES)----- 3,72
 Endil Otis "Peggy" GOFF 2,40
 Ernest Lonnie----- 3,107
 Ernest Olen----- 4,57
 Ernest Ray----- 4,29
 Ernie Lee----- 4,57
 Essie GRISSUM----- 3,113
 Ethel Gertrude SUMMERS- 4,33
 Ethel Margaret (WELSH)- 4,52
 Ethel May CONNER----- 1,137
 Ethel May (RUMBAUGH)--- 1,151
 Ethel RICHER----- 4,22
 Ethna "Belle" THORN---- 1,23
 Etta M WALLACE----- 2,26
 Etta May----- 4,11
 Eugene----- 3,54
 Eugene John----- 4,82
 Eugenia F (HARRIS)---- 3,38
 Eugenia Florence GILMER 3,84
 Eunice C (DOLDOW)----- 1,112
 Eva Elizabeth----- 3,116
 Eva Jane (McCABE)----- 4,43
 Eva McCUTHEON----- 1,63
 Eva S M (DICKEY)----- 2,22

CALLEN, Evelyn B McCRARY- 4,80
 Evelyn F DIMENTRAL----- 2,36
 Evelyn L (DEL REERE)--- 4,68
 Evelyn McKINNEY----- 1,102
 Everet Richard----- 1,128
 CALLEN, Fannie B (GLICK)- 4,51
 Fannie (LOGAN)----- 3,35
 Fay----- 4,29
 Faye WOLF-BACKENSTOCE-- 1,103
 Fern Leah (HICKS)----- 1,155
 Fern Margaret (O'HARROW) 3,117
 Fern (TURNER)----- 4,22
 Flora----- 3,58
 Florence (BROWN)----- 4,22
 Florence Barbara (VOGEL) 1,99
 Florence C (SCHUCHMAN)- 1,85
 Florence Gertrude----- 1,75
 Florence Mae (BRISLIN)- 1,152
 Florence ROBBINS-CHARLTON 1,85
 Fonda Loy SIZEMORE----- 3,206
 Frances----- 1,143
 Frances "Betty" JONES-- 1,127
 Frances E (FORINGER)--- 1,57
 Frances G "Fanny"----- 2,4
 Frances (RUPP)----- 1,58
 Francis Marion----- 4,27
 Francis Melvin----- 1,75
 Frank----- 1,32
 Frank----- 1,73
 Frank Hays----- 4,15
 Frank M----- 1,22
 Franklin Leigh----- 1,169
 Fred Marvin----- 1,54
 Frederick Alvin----- 1,75
 Frederick Charles----- 1,162
 Frederick Earl----- 1,75
 Frederick Torrance----- 2,32
 CALLEN, Gary B----- 4,57
 Gary Glenn----- 1,235
 Gayelynn Arden GRIFFIN- 3,310
 Gayle----- 1,163
 "Genie" (HARRIS)----- 3,38
 George----- 4,10
 George (1785)----- pg 13
 George (1882)----- 1,99
 George (1892)----- 1,77
 George Alexander----- 3,18
 George C----- 4,9
 George Francis----- 2,51
 George Harold----- 4,79
 George Leslie----- 4,26
 George M----- 3,40
 George M (1841)----- 3,18
 George Marian----- 3,49
 George P----- 4,15
 George Raymond----- 2,63

CALLEN, George W----- 3,19
 George Walter----- 1,78
 George Wayne----- 2,32
 Georgia Ann----- 3,41
 Georgia B GANDY----- 3,78
 Georgia GOODLOE----- 2,27
 Georgia Jane DAWSON---- 1,171
 Georgia Rose (KING)---- 2,51
 Germaine (ROARK)----- 1,153
 Gilbert Eldon----- 3,117
 Gilbert J "Jip"----- 4,47
 Gladys LAWSON----- 1,111
 Gladys Agnes (PIEPER)-- 2,47
 Gladys (EARLE)----- 1,163
 Gladys (STOPP)----- 1,140
 Gleave----- 2,29
 Glenda Jacquita SULLIVAN 3,292
 Goldie Almeda (HEPLER)- 1,128
 Grace (FLYNN)----- 1,86
 Grace Kathryn----- 1,85
 Grace TIBBENS----- 1,51
 Gregory Paul----- 1,251
 Gregory Thomas----- 3,311
 Gwendolyn Mardell----- 1,78
 Gwenleen M MARLOVITS--- 1,180
 CALLEN, Hal R----- 3,204
 Halley G (ALLEN)----- 3,109
 Hamilton Harris----- 3,83
 Hamilton Henderson----- 3,38
 Hannah E (HILTON)----- 4,20
 Hannibal Dekalb----- 3,20
 Hannibal Dekalb Jr----- 3,20
 Harold----- 1,140
 Harold Curtis----- 1,80
 Harold Edward----- 1,195
 Harold Eugene----- 4,55
 Harold Leonard----- 4,79
 Harold Page----- 1,81
 Harold Verne----- 1,116
 Harold Wesley----- 4,55
 Harriet (1846)----- 2,12
 Harriet----- 2,3
 Harriet McMURRY----- 4,8
 Harriet C MYERS----- 2,2
 Harris H----- 3,45
 Harrison----- 1,9
 Harry Clyde----- 1,163
 Harry Earl Jr----- 1,153
 Harry Earl Sr----- 1,73
 Harry Kenneth----- 1,221
 Harvey Edwin----- 1,24
 Harvey Gordon----- 1,244
 Harvey J----- 4,29
 Hattie Belle JOHNSON--- 1,112
 Hattie HARRIGER----- 1,50
 Hazel----- 1,79

CALLEN, Hazel Adaline (MOHNEY)	1, 35
Hazel BUCCIGROSSI	1, 131
Hazel Gladys MILLER	4, 30
Hazel Irene ALBRIGHT	1, 154
Hazel J (KINNEY)	1, 181
Heather Nicole	3, 383
Helen (BLACK)	4, 56
Helen (HENRY)	1, 145
Helen (OSTRING)	4, 62
Helen P (HOWARD)	2, 45
Helen (STOLTZ)	1, 140
Helen (TAYLOR)	2, 38
Helen WOODS	1, 144
Hemet C	2, 43
Henrietta (PALMER)	1, 161
Henriette F (JENSEN)	1, 110
Henry	4, 2
Henry DeKalb	3, 106
Henry H	1, 53
Herbert Ralph	1, 44
Hiedi (JOHNSON)	4, 71
Holly	3, 299
Holly Joanne	1, 245
Howard Maybon	1, 130
Howard Wayne	1, 260
Howi (Howard?)	1, 17
Hugh (1808)	2, 4
Hugh (1822)	1, 26
Hugh Elmo	1, 63
Hugh Filbert	2, 15
Hugh Jackson	3, 35
Hugh Jr	1, 16
Hugh Smith	1, 66
Hugh Sr	1, 3
Hugh Torrance	2, 14
Hugh Worthington	1, 32
Hulda Mary (THOMPSON)	1, 127
Hurlbert	1, 64
Hurlbert (1877)	1, 28
CALLEN, Ida (CATES)	1, 77
Ida Belle LOGAN	1, 64
Ida (GOODMAN)	3, 107
Ida (McKAY)	3, 106
Inabee MILLER	4, 30
Iona Barbara FOWLER	1, 97
Isabella J	1, 9
Ira Clayton	4, 30
Ira Dave	4, 57
Irena Mae (DODD)	4, 31
Irene Glen	4, 29
Irene (HOLMES)	3, 108
Irene Inez (BRONSON)	1, 178
Irma M	1, 52
Irwin Samuel	4, 31
Issac Elhannon	3, 22
Ivan Lanard	4, 31

CALLEN, J.W. (1849)	1, 22
Jack	3, 354
Jack Lawrence	1, 242
"Jack" Walton Jr	3, 81
Jackie Lynn (1938)	3, 293
Jackie Lynn (1958)	3, 388
Jackson	1, 25
Jacquilyn (HELD)	2, 60
Jacquilyn (VanORNUM)	3, 205
Jaime Leigh	3, 308
James	1, 2
James	1, 217
James	3, 20
James 1st	pg 12
James (1770)	3, 3
James (1808)	1, 14
James (1913)	3, 58
James Alexander	3, 19
James Arthur	1, 58
James Blaine	4, 69
James Cicero	3, 48
James Clinton	3, 383
James Donald	1, 177
James Duane	1, 256
James Duane II	1, 256
James Duane III	1, 256
James Espy	1, 62
James Fleming	1, 21
James Harry	1, 69
James Hardin	1, 24
James Hugh	1, 54
James L	1, 44
James Leigh	1, 169
James LeRoy "Lee"	1, 129
James M	3, 19
James Milton	1, 96
James P	4, 3
James Polk	4, 16
James Riley	4, 51
James Robert	3, 72
James Russell	1, 205
James Socrates "Crat"	3, 106
James Watson	1, 35
James Windell	4, 70
Jami Elizabeth	1, 256
Jammie Gray	4, 70
Jane	4, 3
Jane (EVANS)	4, 3
Jane C (WEST)	3, 5
Jane E (ELLIOT)	1, 16
Jane Eliza NICKOLS	1, 66
Jane FLOYD	3, 12
Jane (McILROY)	pg 10
Jane H "Jennie" (PAUL)	2, 2
Jane (SHADLE)	1, 17
Jane THOMPSON	2, 1

CALLEN, Janet----- 4,84
 Janet Elvira Cramer---- 1,35
 Janet Louise (SAUL)---- 1,256
 Janet Marie----- 4,66
 Janice Louise----- 3,307
 Janice Sue (GRIFFITH)-- 2,59
 Janie Faye (DEAN)----- 3,293
 Jannett TROSPER----- 3,204
 Jannette CRAMER-HASLEY- 1,36
 Jennie Jo----- 4,85
 Jaren Lynn----- 3,388
 Jason Frederick----- 4,70
 Jason Patrick----- 1,243
 Jason Tanner----- 2,60
 Jason Wendell----- 4,82
 Jay----- 1,141
 Jean (BREEDLOVE)----- 2,32
 Jean Ann (BISHOP)----- 2,56
 Jean Ann (THOMAS)----- 1,258
 Jean Cornelia DORCUS--- 1,36
 Jeana Sue HUBER----- 2,56
 Jeanne E (BAILEY)----- 2,61
 Jeannette M (MURRELL)-- 1,276
 Jeffery Arthur----- 1,243
 Jeneva RODGERS----- 2,22
 Jennie ADAMS----- 3,42
 Jennie (CLARK)----- 1,48
 Jennifer Lea----- 3,389
 Jennifer Renee----- 1,256
 Jeremy----- 4,85
 Jeremy Shawn----- 1,243
 Jeremy Wade----- 3,383
 Jerry Paul----- 1,263
 Jerry Ray Jr----- 3,308
 Jerry Ray Sr----- 3,212
 Jessie Benton (BROOKS)- 1,49
 Jessie Dale----- 2,49
 Jessie James----- 3,109
 Jessie Orville----- 4,37
 Jewell----- 3,111
 Jill----- 3,297
 Jim P----- 3,204
 Joan----- 4,62
 Joan (BOWERSOX)----- 1,242
 Joan Carol (SCHMITZ)--- 1,239
 Joan (DIMMOCK)----- 1,235
 Joann (HARRISON)----- 3,291
 Jody Lee----- 1,217
 Johanna----- 2,2
 John----- 1,5
 John----- 3,20
 John (1733)----- pg 8,9
 John (ca 1765)----- 3,2
 John (1799)----- 1,10
 John (1830)----- 1,27
 John A Logan----- 4,15

CALLEN, John Andrew----- 4,21
 John Carr----- 3,30
 John Dale----- 1,54
 John Elliott----- 1,172
 John "Garry"----- 1,164
 John H----- 1,61
 John H----- 3,77
 John Harvey----- 1,35
 John Jay (1944)----- 1,245
 John Jay (1966)----- 1,215
 John Kerr----- 3,8
 John Leonard Jr----- 1,224
 John Leonard Sr----- 1,155
 John Leroy----- 4,50
 John Ludke----- 2,32
 John Michael----- 1,224
 John Michael----- 4,67
 John Murray----- 1,21
 John Norris----- 4,43
 John Orval----- 4,82
 John Preston----- 4,69
 John Spurlock----- 4,9
 John R----- 4,8
 John Randall----- 1,219
 John Ross----- 3,31
 John William----- 1,126
 Jon Michael----- 1,178
 Jonathan Edward----- 4,26
 Jordan Lee----- 1,252
 Joseph (1768)----- pg 10
 Joseph (1829)----- 1,23
 Joseph Albert----- 1,54
 Joseph Edward----- 4,16
 Joseph Raymond----- 1,270
 Joseph Worthington---- 1,32
 Josephine BAKER-GRABASY 1,192
 Josephine (BROHAMER)--- 1,87
 Josephine BUSCHMAN---- 2,18
 Josephine COTCHEL----- 4,10
 Josephine (HUEY)----- 4,62
 Josephine M (HENDERSON) 1,118
 Josephine M----- 1,87
 Josephine Nelle (MEASE) 1,115
 Joshua Michael----- 3,311
 Josiah J----- 1,28
 Josiah P----- 1,59
 Josie Alva----- 1,111
 Josuah----- 1,250
 Josuah David----- 1,260
 Joy Roberta STRINGHAM-- 3,117
 Joye Jean RAGAN----- 3,296
 Juanita Fern RAY----- 1,85
 Judith N (HARTLEY)---- 2,52
 Judy (HONSWALT)----- 4,64
 Judy Mae MORROW----- 3,294
 Judy OTTO----- 1,162

CALLEN, Judy PARCEL----- 4,81
 Julie Lynn----- 4,82
 Julie M (LOWE)----- 1,133
 Julia Nancy MATHER----- 1,170
 CALLEN, Kamla----- 1,165
 Karla----- 1,242
 Karen Ann----- 1,172
 Kate----- 1,22
 Kateline K----- 1,235
 Kathleen P TODD----- 1,183
 Kathleen Wilma (FORD)--- 1,184
 Katherine E PETERSON--- 1,277
 Kathy Lynn----- 1,172
 Katrina Michelle----- 1,269
 Kelly (EDMISTON)----- 1,178
 Kelly Leanne----- 2,63
 Kenneth----- 1,142
 Kenneth Elmer----- 2,33
 Kenneth Eugene----- 4,62
 Kenneth Lee----- 1,258
 Kenneth "Lee"----- 2,50
 Kenneth Lee (1929)----- 4,60
 Kenneth Michael----- 4,75
 Kenny----- 3,303
 Kent M----- 1,166
 Kevin Eugene----- 4,84
 Kevin Kinney----- 1,236
 Kevin Kinney Jr----- 1,236
 Kimberly Joy RUNYON--- 1,286
 Kris M----- 1,166
 Krista Kay----- 1,235
 Kristen----- 1,242
 CALLEN, Lafayette A----- 3,37
 Lallah Lillian----- 3,116
 Lamoine Coy----- 3,206
 Lance Melvin----- 2,59
 Laramie Lin----- 2,59
 Larry----- 3,299
 Larry Eugene----- 1,252
 Larry Lee----- 4,52
 Larry Wayne----- 1,266
 Latrelle----- 2,32
 Laura Belle SMITH----- 1,59
 Laura (BETZ)----- 1,69
 Laura A SPURGEON----- 4,15
 Lawrence Elvin----- 4,45
 Leah Nicole----- 1,243
 Lee----- 2,25
 Lee (EWALT)----- 4,79
 "Lee" Kenneth Lee----- 2,26
 "Lee" James LeRoy----- 1,129
 Leigh Bates----- 1,96
 Leila V----- 1,52
 Leisha Ann----- 1,252
 Lelia Lois----- 1,24
 Lementine America (HAYS)4,15

CALLEN, Lena (LOWERY)---- 3,200
 Lena Renee----- 2,65
 Leo Laroice----- 3,291
 Leon John----- 1,80
 Leona Volza----- 1,75
 Leroy Monroe----- 3,22
 Leslie (COTTRELL)----- 2,62
 Lester Cornelius----- 3,59
 Lettie----- 1,23
 Lewis W----- 2,6
 Libby----- 1,162
 Lida (Melida Ann)----- 1,25
 Lillian H----- 1,81
 Lillian Merle CLINE---- 4,46
 Lillian Myra (HOWRY)--- 4,27
 Lillie Alice COLE----- 2,23
 Linda Diane RIDLEN----- 1,262
 Linda Jayne----- 1,117
 Linda K (BURHAM)----- 2,63
 Linda Mae----- 4,72
 Linda Marie (MATTERN)-- 1,226
 Linda Rea----- 4,56
 Lindy Ann----- 1,157
 Lisa Kay----- 1,172
 Lisa Marie (SCHEER)---- 3,311
 Lititia Agnes SMITH---- 1,24
 Lizzie C (CULVERHOUSE)- 3,31
 Lloyd Frank----- 4,31
 Lloyd Leo----- 2,38
 Lloyd Leonard----- 4,63
 Lloyd Lonnie----- 1,181
 Lloyd Trudell----- 1,193
 Loa "Maggie" (EMERSON)- 3,116
 Lodusky Pulaski----- 3,5
 Lodusky Pulaski (18___)- 3,22
 Lois Jean----- 1,121
 Lon Edward----- 1,185
 Lonnie Edward----- 3,199
 Lonnie Edward----- 1,185
 Loraine STARK----- 3,27
 Loretta----- 1,73
 Lori Jean----- 1,245
 Lorri----- 3,299
 Lottie (BURK)----- 4,57
 Lottie O (SMITH)----- 1,61
 Louella J KENYON----- 4,15
 Louis Trudell----- 1,246
 Louisa M----- 2,3
 Louisa Theresa (BATES)- 1,44
 Louise Emma SCOTT----- 1,41
 Louise Esther (MURRAY)- 1,142
 Louise RIFENBERRICH--- 1,72
 Luella Mae (DARBISON)-- 3,197
 Lucien Seth----- 1,45
 Lucill Marie ALLEN----- 1,156

CALLEN, Lucille HARRELL-- 3,42
 Lucinda (1837)----- 1,9
 Lucinda (1850)----- 3,18
 Lucreau ----- 1,45
 Lucy----- 1,15
 Lucy (1875)----- 1,36
 Lucy (RIGGS)----- 1,77
 Lucy (WALKER)----- 3,83
 Lulu A CONWAY----- 3,74
 Luther----- 2,17
 Lynda Mary (DAVIS)----- 1,265
 Lynette Jean----- 1,185
 CALLEN, M.J.----- 1,10
 M.M.----- 1,10
 M.S.----- 1,22
 Mabel----- 1,44
 Mabel Annagrace----- 1,96
 Mabel Clara (MULLINS)-- 3,211
 Mabel PETREE----- 1,51
 Mabelle Claire(LAWTHER) 1,126
 Mable MCGINNIS----- 1,125
 Mack Americus----- 3,115
 Mae Magdelene POSZYWAK- 2,35
 Maggie (BOWDISH)----- 1,36
 Malinda----- 1,15
 Malinda J (LANDRETH)--- 2,14
 Margaret----- 1,1
 Margaret (1843)----- 1,21
 Margaret----- 1,73
 Margaret----- 1,72
 Margaret----- 3,46
 Margaret (1851)----- 3,19
 Margaret (AHARRAH)----- 1,50
 Margaret Ann----- 2,37
 Margaret DICKEY----- 2,5
 Margaret DYE----- 1,83
 Margaret (EDISON)----- 4,19
 Margaret Emma (CORNMAN) 1,62
 Margaret GLASS-KIRKPATRICK 3,29
 Margaret (INGRAM)----- 4,7
 Margaret Jane MASTERSON 2,16
 Margaret N McELWAIN---- 3,34
 Margaret R (ELLIOTT)--- 4,60
 Margaret W SHULTZ----- 3,73
 Margaret (WILEY)----- 3,46
 Margie----- 3,298
 Margurete REAVIS----- 3,175
 Marietta----- 2,6
 Marilyn L (MOSHIER)--- 1,166
 Marion----- 3,56
 Marion West----- 3,58
 Marjorie C (BENNETT)--- 1,198
 Marjorie D (GOULD)---- 1,164
 Marjorie METTLER----- 1,216
 Marjorie SHIPP-DOTY--- 3,298
 Marlys (MAGNUS)----- 2,50

CALLEN, Mark N----- 1,51
 Marshall K----- 1,166
 Marshall M----- 4,8
 Martha Annabelle----- 4,30
 Martha E (LAMB)----- 1,54
 Martha Jane----- 4,16
 Martha "Patsy" (CATES)- 4,8
 Martin----- 4,8
 Martin T----- 1,44
 Martin V----- 3,19
 Marvin Hubert----- 4,64
 Mary----- 2,44
 Mary (1775)----- 1,3
 Mary (1911)----- 4,10
 Mary A----- 1,14
 Mary A (1828)----- 1,9
 Mary A (DIDANITO)----- 2,62
 Mary A (GOODENOUGH)---- 1,26
 Mary A McDonnia----- 4,3
 Mary Ann----- 1,21
 Mary Ann----- 1,25
 Mary Ann GILMER----- 3,33
 Mary Ann (JACKSON)---- 1,9
 Mary Ann KIENZT----- 2,58
 Mary Ann (REDIC)----- 1,27
 Mary Anne----- 2,62
 Mary (BOYD)----- 3,21
 Mary Burnet----- 3,5
 Mary C (FOSTER)----- 4,35
 Mary Catherine AMES--- 1,240
 Mary Celeste FREEMAN--- 1,32
 Mary (CHAMBERS)----- 2,4
 Mary CHOATE----- 3,15
 Mary COMPTON----- 1,72
 Mary CULVERHOUSE----- 3,47
 Mary Dakota----- 1,35
 Mary E (1844)----- 2,2
 Mary E (AMBROSE)----- 3,59
 Mary E ANDERSON----- 1,58
 Mary E ATHERTON----- 2,39
 Mary Edna (THOMAS)---- 2,33
 Mary Elea----- 4,11
 Mary Eliza Jane----- 1,65
 Mary Eliza PURCELL---- 3,87
 Mary Elizabeth----- 3,21
 Mary Elizabeth (DOUGLAS) 4,2
 Mary Elizabeth POKORNE- 2,31
 Mary Elizabeth GILLIGAN 1,191
 Mary Elizabeth (QUALLS) 3,388
 Mary Elizabeth (VACLAVAK) 4,69
 Mary Ella CATES----- 3,76
 Mary Ella (PETERS)---- 1,66
 Mary Ellen (ARMSTRONG)- 4,16
 Mary Ellen (COWAN)---- 1,28
 Mary Foster----- 3,7
 Mary GALBRAITH----- 1,6

CALLEN, Mary I (DOWDA)--- 3,58
 Mary Isabella (DERBY)-- 4,22
 Mary Isabella "Mayme"-- 4,22
 Mary Jane (CHAMBERS)--- 4,11
 Mary Jane (GARNER)----- 2,17
 Mary L----- 1,64
 Mary Leila----- 1,32
 Mary Litia----- 1,23
 Mary L ROCK----- 4,28
 Mary Lou (JACKSON)----- 3,42
 Mary Louise----- 1,96
 Mary Luceta BELDING---- 1,46
 Mary M (GRUVER)----- 1,53
 Mary "Melissa" (MARTIN) 3,19
 Mary (MADIGAN)----- 1,165
 Mary Margaret (COULSON) 4,23
 Mary Margaret (WIDEL)-- 1,172
 Mary McGAHEE----- 3,15
 Mary MULVANEY----- 4,4
 Mary Patricia----- 1,271
 Mary Olive----- 1,250
 Mary Opal (SHEPPERD)--- 4,40
 Mary Pearl----- 1,77
 Mary Rebecca HOLLER---- 1,24
 Mary REICHART----- 1,13
 Mary Ruth (DAHLMAN)---- 2,48
 Mary Ruth (MINESKY)---- 1,130
 Mary (SILVES)----- 1,67
 Mary SLACK----- 1,34
 Mary Sophia (ROSE)----- 1,84
 Mary STILES----- 1,51
 Mary (STRATTON)----- 1,32
 Mary (WEIR)----- 1,12
 Mary (WILSON)----- 1,14
 Mary (WYATT)----- 2,15
 Matilda----- 2,1
 Matilda (DAVIS)----- 3,18
 Matilda E NALE----- 1,199
 Matilde RICKER----- 1,39
 Matthew----- 2,2
 Matthew (1846)----- 2,2
 Matthew Reed----- 4,69
 Mattie Lester (ROANE)-- 3,81
 Maude----- 1,44
 Maude May----- 2,15
 Maurine Elizabeth (BEAR) 1,157
 Max Harold----- 4,52
 May M----- 3,54
 Melaine P (MILLER)---- 2,65
 Melida Ann SHAFFER---- 1,26
 Melissa (MARTIN)----- 3,19
 Melissa Nan----- 2,52
 Melonie Ann SWENSON---- 3,312
 Melvin Harvey----- 1,79
 Melvin Kenneth----- 2,59
 Michael----- 1,145

CALLEN, Michael----- 1,228
 Michael Cole----- 2,52
 Michael Stanley----- 1,229
 Michael Stephen----- 1,269
 Michelle----- 4,81
 Mildred A GRAYSON----- 2,31
 Mildred (DENNIS)----- 3,106
 Mildred Louise CAMPBELL 1,204
 Mildred Olita----- 4,37
 Miles D----- 1,22
 Milton Earl----- 1,53
 Mina Ree DOWD----- 4,30
 Minnie----- 3,58
 Minnie Ola----- 3,104
 Molly Walter (BENNETT)- 3,57
 Murray C----- 3,109
 Myra (KROPP)----- 3,299
 Myrtie Ellie----- 1,31
 Myrtle----- 4,15
 Myrtle E (CLAYPOOL)---- 1,244
 Myrtle Ida DRAPER----- 4,36
 CALLEN, Nancy----- 1,15
 Nancy Agnes (KERR)---- 3,2
 Nancy E (NUTTER)----- 1,45
 Nancy E (SHEPARD)----- 4,38
 Nancy H PICKENS-DONALDSON 3,28
 Nancy (HADDAD)----- 4,77
 Nancy Iona (HAMILTON)-- 3,111
 Nancy J (HUFF)----- 3,53
 Nancy Jane----- 1,8
 Nancy KIRKPATRICK----- 3,9
 Nancy Lucinda SMITH---- 3,12
 Nancy M----- 1,17
 Nancy (MALLORY)----- 4,82
 Nancy S HORNBEAK-McELWAIN 3,36
 Nancy Simpson (KENNEDY) 3,8
 Naomi----- 1,73
 Ned Given----- 3,210
 Nellie Almira (DEWEY)-- 1,96
 Nellie Catherine----- 1,96
 Nellie Grace (CLINE)--- 1,72
 Nellie Irene FISCUS---- 1,139
 Nettie CRAMER-HASLEY--- 1,36
 Nila Jean (STOKESBERRY) 4,61
 Nora May THUMM----- 1,36
 Norma Jean WHIPKEY---- 3,209
 Norma R (ESTES)----- 4,58
 Novita PATRICK----- 3,304
 CALLEN, Olive L (GIBSON)- 1,193
 Olivia (STEWART)----- 3,3
 Ollie Booker----- 3,110
 Ollie May (KIRBY)----- 2,25
 Ona JOHNSON----- 3,198
 Oneca SHAW----- 3,305
 Opal----- 4,26
 Opal----- 3,106

CALLEN, Ora Iva----- 3,22
 Ora (SUMMERS)----- 1,100
 Oran Williams----- 4,22
 Orelia REED----- 3,203
 Orpha (ELLIOTT)----- 4,37
 Orris James----- 4,43
 Orvetta (HOLMES)----- 3,106
 Orville Loraine----- 4,22
 Orville Talmadge----- 1,123
 Osa Gay----- 4,26
 Ottillia Anna (GROB)--- 1,83
 Otto Orel----- 1,114
 CALLEN, Page----- 1,81
 Pamela (MANN)----- 1,235
 Pamela B (RHEA)----- 3,389
 Parlee Oregon----- 3,22
 Patricia AUSTIN----- 1,220
 Patricia Jean----- 1,177
 Patricia Lee (BOYD)---- 3,212
 Patrick-----pg 11,12-1,1
 "Patsy" Martha (CATES)- 4,8
 Patty Ann WYGAL----- 1,190
 Paul Cole----- 2,31
 Paul Ellsworth----- 1,198
 Paul Roscoe----- 3,116
 Paula----- 1,129
 Paulette (FULLER)----- 1,235
 Paulette M MUTLEY----- 2,50
 Pauline (JORDAN)----- 1,194
 Pearl Arzula SCHIFFGENS 1,138
 Pearl DUFFER----- 1,72
 Penelopy (MOUPINE)----- 4,9
 Perle (male)----- 1,118
 Perry Monroe----- 4,9
 Perry Monroe (1822)---- 4,2
 Pheobe (RHEA)----- 1,136
 Phillip James----- 1,217
 Phillis (LEE)----- 4,55
 Philo LeRoy----- 1,87
 Phyllis Laura----- 1,142
 Phyllis Louise (PINARD) 3,307
 Pinkney----- 3,19
 "Polly" MULVANEY----- 4,1
 Preston Alex----- 4,15
 Priscilla----- 1,21
 Pryor Lee----- 4,15
 CALLEN, Rachel (TOWNSEND) 2,6
 Ralph Bert----- 3,58
 Ralph E----- 3,204
 Ralph Lauren----- 1,53
 Randy----- 1,242
 Randy Lee----- 1,244
 R Raymond----- 3,42
 Raymond Arthur----- 1,133
 Raymond Francis----- 2,34
 Reba Marivee PACKARD--- 4,51

CALLEN, Rebecca E (GANDY) 3,30
 Rebecca Jane MCKOWN---- 2,10
 Rebecca P (ALBERTSON)-- 4,22
 Rebecca R----- 1,235
 Regina B (FURY)----- 1,117
 Rhonda Whelin (HALL)--- 1,282
 Richard----- 4,47
 Richard Cater----- 3,42
 Richard Eppler----- 4,56
 Richard Eugene----- 4,56
 Richard Henry----- 3,59
 Richard Michael----- 1,221
 Richard Roy----- 1,181
 Rickard Patrick----- 1,222
 Ricky Dale----- 2,65
 Riley----- 3,20
 Riley Seigh----- 4,16
 Robbie----- 4,71
 Robby Lee----- 2,64
 Robert----- 1,219
 Robert Bruce----- 1,219
 Robert C----- 1,158
 Robert H----- 3,17
 Robert H----- 3,7
 Robert Harold----- 1,128
 Robert Lee----- 2,64
 Robert Martin----- 1,206
 Robert Miller----- 2,3
 Robert Ray----- 2,28
 Robert Townsend----- 2,17
 Robert Vance (1906)---- 2,41
 Robert Vance (1952)---- 2,61
 Robert Vincent----- 3,211
 Roberta Louise LaBORDE- 1,201
 Rodney James----- 2,62
 Rolland Charles----- 1,119
 Ron----- 4,81
 Ronnie L----- 3,204
 Rosa A----- 2,6
 Rosa B----- 4,18
 Rosa Dee (WALLACE)---- 1,52
 Rosco----- 1,77
 Roscoe Joseph----- 3,116
 Roscoe Murlin "Rock"--- 3,205
 Rose C (OTT)----- 2,19
 Rose E (MOONEY)----- 1,31
 Rose M (FREDERICK)---- 1,269
 Ross----- 3,7
 Roy Eugene----- 1,123
 Rudolph Plato----- 3,59
 Rudy E----- 1,72
 Russel Eugene----- 1,285
 Russell Deane----- 3,307
 Ruth Elaine AKINS----- 1,254
 Ruth WANGAMAN----- 1,72
 CALLEN, Sadie (FENNEL)--- 1,73

CALLEN, Salley (NICHOLS)- 1,235
 Sallie E----- 3,46
 "Sallie" Sarah (LITTLETON) 3,12
 Samuel (1811)----- 1,15
 Samuel (1818)----- 2,6
 Samuel Edward----- 1,24
 Samuel H----- 4,3
 Samuel Henry----- 4,18
 Samuel Miller----- 2,15
 Samuel P----- 2,2
 Samuel Sr----- 2,1
 Samuel Vance----- 2,25
 Samuel Watson (1887)--- 1,85
 Samuel Watson (1915)--- 1,85
 Samuel Watson Jr----- 1,161
 Sandra Louise CAPPS---- 3,309
 Sandra Sue----- 4,55
 Sarah----- 1,143
 Sarah----- 3,19
 Sarah (1851)----- 2,3
 Sarah (1857)----- 4,10
 Sarah (1874)----- 3,54
 Sarah (ALEXANDER)----- 3,4
 Sarah A.L.----- 4,3
 Sarah Agnes Marie----- 2,62
 Sarah Ann BIRD----- 1,37
 Sarah Ann STEWART----- 3,12
 Sarah Beth----- 3,388
 Sarah Blanch----- 1,54
 Sarah BRANDON----- 1,7
 Sarah C (AYERS)----- 3,22
 Sarah Christian----- 1,265
 Sarah E (1846)----- 1,14
 Sarah E "Sallie"----- 3,46
 Sarah Elizabeth----- 3,22
 Sarah Ellen (BAKER)---- 2,15
 Sarah HAMILTON----- 1,8
 Sarah (HENNEN)----- 1,1
 Sarah I----- 3,19
 Sarah Jane----- 1,25
 Sarah Jane McBRYAR----- 2,7
 Sarah (LITTLETON)----- 3,12
 Sarah Loduskey----- 3,21
 Sarah Louise----- 3,310
 Sarah Margaret (BOWDISH) 1,36
 Sarah (NICKOLS)----- 1,33
 Sarah WIGRIM----- 1,146
 Sarah WILSON----- 1,11
 Sarah WOODS----- 2,1
 Sarepta "Jennie" LACY-- 1,56
 Scott Keith----- 4,85
 Scotty Duane----- 4,77
 Sethy (BRYAN)----- 4,7
 Shaffer Alexander----- 1,128
 Sharon Ann (YARNELL)--- 1,242
 Sharon K DeHART-FORD--- 3,385

CALLEN, Shawn Kenneth---- 2,60
 Sheri Lavonne----- 4,68
 Sherri----- 4,81
 Sherry (REED)----- 2,32
 Shirley A MIKOTA----- 1,275
 Shirley L (ROGERS)----- 2,65
 Shirley Ruth (BENTLEY)- 1,217
 Shirley Ruth YOUNG----- 1,151
 Sidney P----- 2,4
 Simon (1762)----- pg 10
 Simon "Luther"----- 2,19
 Sina (EARLY)----- 1,63
 Sindy----- 1,165
 Socrates Polasky----- 3,57
 Socrates Plato----- 3,58
 Socrates Plato (1856)-- 3,22
 Socratus Plato----- 3,5
 Solomon----- 1,8
 Solomon (1843)----- 3,18
 Stacy----- 4,84
 Stacy Lynne (WILLIAMS)- 3,308
 Stashie (TACKETT)----- 1,123
 Stella (FRANKS)----- 3,110
 Stella May (SQUIRES)--- 1,111
 Stephanie----- 4,84
 Stephanie Lynn----- 3,389
 Stephenie----- 4,71
 Steve----- 4,55
 Steven Glenn----- 3,389
 Steven Michael----- 1,172
 Sudie (COOKSEY)----- 4,10
 Summer Marie----- 3,310
 Susan Jane (ARGO)----- 4,21
 Susan Lynn HALL----- 1,190
 Susan Marie BORDGES--- 1,274
 Susan Rene----- 1,184
 Susanne----- 1,145
 Susanne Marie HARGIS--- 2,30
 Sylvia----- 3,110
 CALLEN, Tandra DILBECK--- 3,293
 Tammie J CAMP-MISNER--- 4,78
 Tammie (KELSELL)----- 4,75
 Tamsay GLADFELTER----- 4,8
 "Tarz" Henry----- 2,38
 Tennessee S.J. LEATHERS 3,5
 Teresa----- 3,201
 Teresa Ann RAUCH----- 1,283
 Teresa J (MEADOWS)----- 1,243
 Teresa Jane HUDDLESTON- 3,390
 Terri (WALLACE)----- 1,245
 Terry Gene----- 3,206
 Thelma Belle----- 1,127
 Thelma L (BEERBOWER)--- 4,82
 Thelma Renee TOEPFER--- 4,86
 Theodore Kenneth----- 1,221
 Theophilus----- 2,11

CALLEN, Theresa LAWLEY--- 3,201
 Thesha Diane----- 3,210
 Thomas----- 1,9
 Thomas----- 1,25
 Thomas (1762)----- 3,5
 Thomas (1781)----- pg 12
 Thomas (1802)----- 3,2
 Thomas (1851)----- 1,43
 Thomas (1901)----- 3,117
 Thomas (1931)----- 1,141
 Thomas A----- 3,46
 Thomas Arnold----- 3,46
 Thomas Bonepart----- 3,5
 Thomas Bonepart (1847)- 3,20
 Thomas Bradley----- 1,219
 Thomas Bruce----- 3,21
 Thomas Edward----- 1,67
 Thomas Edward----- 1,224
 Thomas Eugene----- 1,178
 Thomas J----- 1,51
 Thomas Jefferson----- 1,31
 Thomas Jerry----- 3,311
 Thomas Knight----- 3,108
 Thomas M----- pg 13
 Thomas McAllister----- 3,22
 Thomas Munroe----- 3,39
 Thomas Wayne----- 1,128
 Thompson LeMoyn----- 1,194
 Thorvell----- 3,111
 "Tillie" NALE----- 1,122
 Timothy James----- 3,310
 Timothy Joseph----- 1,221
 Timothy Mark----- 1,265
 Tina----- 4,85
 Todd O'Neil----- 1,227
 Tommie Helm (LEE)----- 3,42
 Tommy----- 3,117
 Tonja Lea----- 3,293
 "Tony" Jose----- 1,250
 Tony Vern----- 1,178
 Tony Vern Jr----- 1,178
 Torrance Luther----- 2,38
 Tracey----- 3,303
 Twyla Odella FLEMMING-- 1,134
 CALLEN, Vada L BAKER----- 2,44
 Valerie K----- 2,66
 Valerie PACK----- 3,208
 Velma A ALLISON-HEROD-- 1,160
 Velma V PLATTENBURG---- 4,54
 Venia----- 3,54
 Venice Vernon----- 2,46
 Vera Minnesota MOORE--- 4,49
 Vera Pauline (AMICK)--- 3,204
 Verda Louemma SEIFERT-- 1,68
 Vergie Lois (PUTMAN)--- 4,32
 Vernelle (DONALDSON)--- 2,42

CALLEN, Vernon Hugh----- 2,60
 Vernon Irving----- 1,179
 Veronica (KROPP)----- 3,297
 Vester Kenneth----- 2,47
 Vicki Charlene----- 1,229
 Vickie E (KNIGHT)----- 3,354
 Vickie (McMASTERS)----- 1,266
 Victor Alan----- 1,229
 Vincil----- 4,40
 Viola Gertrude CLARK--- 4,48
 Violet May----- 1,75
 Violet TURNER----- 1,159
 Violette Flow----- 4,38
 Virgie G DAYTON----- 4,51
 Virginia----- 3,83
 Virginia----- 4,47
 Virginia Lee----- 1,119
 Virginia M (WILLIAMS)-- 1,179
 Virginia May GREENO--- 2,30
 CALLEN, Walter Earl----- 1,196
 Walton Eugene Jr----- 3,81
 Walton Eugene Sr----- 3,81
 Wanda (DAMPIER)----- 2,32
 Wanda Marie YORK----- 3,207
 Watson----- 1,17
 "Wayne"----- 1,126
 Wayne Franklin----- 1,169
 Wesley Americus----- 3,115
 West Columbus----- 3,5
 West Jerome----- 3,22
 Whittington Columbus--- 3,22
 Whitney Leigh----- 3,297
 Wilbur----- 1,96
 Wilbur Dean----- 2,56
 Wilbur Deane----- 3,307
 Wiley----- 3,46
 William (1762)----- pg 8
 William (1821)----- 1,22
 William (1870)----- 4,16
 William III----- 3,12
 William Alpheus----- 1,188
 William Arthur----- 1,239
 William Arthur II----- 1,282
 William C----- 1,143
 William Charles----- 1,157
 William Chambers----- 2,4
 William Dwight----- 3,53
 William E----- 4,3
 William Ellsmore----- 1,70
 William Elmer----- 2,24
 William Frederick----- 1,276
 William George----- 1,250
 William H----- 1,14
 William Henry----- 4,22
 William Jr----- 3,4
 William L----- 4,10

CALLEN, William Preston--	4,16	---	CARGILL, David Jasper----	3,114
William Sr-----	pg 10-3,1		Ervin-----	3,114
William Stuart-----	3,12		Imogene-----	3,114
William T-----	1,57		Joann-----	3,114
William Thomas-----	1,77		Oneta-----	3,114
William Torrance-----	2,32		Thelmet-----	3,114
William W-----	1,52		CARNAHAN, Margaret MILLER	2,1
William Wade-----	1,51		CARR, Edith (CALLEN)-----	1,101
Willie-----	3,20		Robert-----	1,101
Wilma-----	1,60-1,74		CARRUTH, Lucy KIRKPATRICK	3,138
Wilma Dean STEWART-----	3,208		CARTER, Richard-----	3,15
Wilma Joyce-----	4,50		Sarah Mexico (CHOATE)---	3,15
Wilma May MARLAR-----	1,233		CASTILLE, Delores ANTILLEY	3,329
Wilma O (WHISLER)-----	4,50		CATES, Emma V CALLEN-----	3,72
Wyman Joseph-----	2,42		Ida CALLEN-----	3,77
CALLEN, Zellman Clay-----	4,26		Martha CALLEN-----	4,8
Zua C-----	3,59		Mary Ella (CALLEN)-----	3,76
"Zula" OVER-----	1,71		Watson Matthew-----	3,76
CALLENS, James-----	3,3		CATO, Ann WILLIAMSON-----	3,62
John-----	3,2		CHAMBERS, Adaline (CALLEN)	4,13
William Jr-----	3,4		Barbara PALMER-IRWIN---	3,341
William Sr-----	3,1		Billie Bob-----	3,256
CALLIN, James-----	pg 12		Brian A "Pat"-----	3,338
John-----	3,2		Carrie Melissa-----	3,337
CALLINS, Thomas-----	3,264		Charles Benjamin-----	3,170
CALLON, Patrick-----	1,1		Charles Michael-----	3,337
William Jr-----	3,4		Daisy D (ANTHONY)-----	3,256
William Sr-----	3,1		Debora Lynn (SPRIGGS)---	3,339
CALLONS, James-----	3,3		Dianne E DONALDSON-----	3,342
Thomas-----	3,5		Frances (BOVARD)-----	2,4
William-----	3,5		Gary Gene-----	3,339
CAMELIN, William-----	pg 11-3,1		Ginney Lee (WILLS)-----	3,339
CAMP, Danny-----	4,78		Jamie Ellen-----	3,343
Jacob Daniel-----	4,78		Jessica Elizabeth-----	3,339
Tammy Jean (CALLEN)-----	4,78		Joe Charles-----	3,257
CAMPBELL, Alabama CHOATE-	3,15		John-----	4,8
Beulah CALLEN-----	2,30		Juanita M (GALLATIN)---	3,337
Caroline (KIRKPATRICK)-	3,24		Juanita Michele-----	3,337
Elizabeth (CHOATE)-----	3,15		Julie Kay-----	3,337
Howard B-----	3,15		Justin Allen-----	3,339
J.N-----	3,24		Kristen Sheppard-----	3,343
John Franklin-----	2,30		Lucy M (SALMON)-----	3,337
Maude (BUCKHORN)-----	2,30		Margaret E (GOODMAN)---	3,343
Mildred L (CALLEN)-----	1,204		Marjorie L (GRIFFITH)---	3,338
CAPPS, Anne Marie-----	3,309		Mark-----	3,343
Bradley Dennis-----	3,309		Martha Gene-----	3,170
Crystal Lee-----	3,309		Mary CALLEN-----	2,4
Dennis Glen-----	3,309		Mary Jane CALLEN-----	4,11
Jenny Lynn-----	3,309		Molly Ann COURSEY-----	3,340
Sandra Louise (CALLEN)-	3,309		Nancy (NORRIS)-----	4,8
Sean Thomas-----	3,309		Nellie M (BALLARD)-----	3,257
Todd Christopher-----	3,309		Shelly Renee-----	3,338
CARD, Emma S (CALLEN)---	1,47		Velma S (GLASS)-----	3,170
William "Allen"-----	1,47		William J-----	4,13
CARGILL, Carole Lee-----	3,114		William Sr-----	2,4
Clara (CALLEN)-----	3,114		CHANNEY, Angie CALLEN---	3,108

CHAPMAN, Buna WILLIAMSON- 3,232
 CHARLTON, Florence (CALLEN) 1,85
 CHEATHAM, Ida HORNADY---- 3,65
 CHOATE, Alabama (CAMPBELL) 3,15
 Amelia (SAMPLE)----- 3,15
 Elizabeth CAMPBELL----- 3,15
 Jamima F WILLIAMS----- 3,51
 Martha Jane MORRIS----- 3,15
 Mary (CALLEN)----- 3,15
 Mary Ann CUMMINGS----- 3,15
 Sarah Mexico CARTER----- 3,15
 Robert S----- 3,15
 Rufus A----- 3,15
 William Alexander----- 3,15
 William Isom----- 3,15
 CHRISMAN, Marsha BAUGHER- 4,73
 CLANTON, An COLLINS----- 3,360
 CLARK, Ann Penton----- 3,247
 Dorothy F McCONAHAY----- 4,65
 Elaine (GLASS)----- 3,247
 Ewell----- 3,247
 Floretta (GLASS)----- 3,248
 Jennie CALLEN----- 1,48
 LLOYD Hubert----- 4,48
 Melissa Bryan----- 3,248
 Neil----- 3,248
 Neil Penton----- 3,248
 Viola Gertrude (CALLEN) 4,48
 CLAYPOOL, Myrtle CALLEN-- 1,244
 CLINE, Artie CALLEN----- 4,45
 Lillian Merle (CALLEN)- 4,46
 Nellie G CALLEN----- 1,72
 Ralph----- 4,46
 CLINTON, Ruby CALLAN----- 3,98
 COCHRAN, Alice (ANDERSON) 1,104
 Walter----- 1,104
 COLE, Annie Hall CALLEN-- 3,37
 Lillie Alice CALLEN----- 2,23
 Naomi (GREEN)----- 2,30
 Richard----- 2,30
 Will----- 2,30
 COLLINS, An D (CLANTON)-- 3,360
 Anastasia (POWERS)----- 3,272
 Annie (McWHIRTER)----- 3,271
 Averil LASHLEY----- 3,359
 Caroline B (BIRD)----- 1,167
 Donald A----- 1,167
 Eleanor----- 3,270
 Gail (BRITAIN)----- 3,360
 James Milton----- 3,360
 John Floyd----- 3,181
 John Floyd, Jr----- 3,270
 John Floyd III----- 3,270
 Martha B (Des SASSURE)- 3,272
 Meredith Purcell----- 3,271
 Mildred E BRADLEY----- 3,362

COLLINS, Mildred E (CADE) 3,273
 Milton Massey----- 3,272
 Olyve (COSTNER)----- 3,270
 Patricia Perkins----- 3,360
 Patricia Powers DURR--- 3,361
 Sarah Margaret SCHENZ-- 3,363
 Robert Milton----- 3,360
 Robert Purcell----- 3,360
 Ruby Estelle (PURCELL)- 3,181
 William Bruce----- 3,273
 COMLEY, Dorothy C BIRD--- 1,92
 COMPTON, Ella DARBISON--- 3,197
 Mary (CALLEN)----- 1,72
 CONNER, Ethel M (CALLEN)- 1,137
 Harry James----- 1,137
 CONWAY, Amanda (CALLEN)-- 3,75
 Andrew J----- 3,74
 Lulu (CALLEN)----- 3,74
 W. Ivy----- 3,75
 COOK, Clifford C----- 3,164
 Clifford M SPANN----- 3,249
 Eva Eulala (GLASS)----- 3,164
 Lena WILLIAMSON----- 3,229
 COOKSY, Sudie CALLEN----- 4,10
 COOLEY, Arlene----- 1,137
 Mavis C WILLIAMSON----- 3,394
 COPELAND, Anne SHAW----- 1,211
 CORNMAN, M Emma CALLEN--- 1,62
 CORRIE, Brett----- 1,234
 Judith E (MARLOVITS)--- 1,234
 Lisa----- 1,234
 Wayne----- 1,234
 COSTNER, Olyve COLLINS--- 3,270
 COTCHEL, Josephine (CALLEN) 4,10
 Zayre----- 4,10
 COTHRAN, Edward Pinkney-- 3,32
 Eliza Jane (CALLEN)--- 3,32
 COTTRELL, Leslie CALLEN-- 2,62
 COULSON, Eliza E (CALLEN) 4,25
 Mary Margaret CALLEN--- 4,23
 Samuel Levi----- 4,25
 COURSEY, Daniel Lee----- 3,340
 Molly A (CHAMBERS)----- 3,340
 Richard Lynn----- 3,340
 Richard Lynn, Jr----- 3,340
 COURTNEY, Crystal----- 3,381
 Jas.----- 3,287
 Kay----- 3,382
 Nancy A (CALLAN)----- 3,287
 COVINGTON, April----- 1,280
 Bill----- 1,280
 Catheleen----- 1,280
 Christopher----- 1,280
 Dale----- 1,280
 Dale Jean (SIMMONS)--- 1,280
 James Robert----- 1,280

COVINGTON, Jim----- 1,280
 Mary----- 1,280
 COWAN, Mary Ellen CALLEN- 1,28
 COWGILL, Alice CALLEN---- 4,1
 Alice (PAYNE)----- 4,1
 Henry----- 4,1
 COX, Elizabeth K (CALLEN) 3,5
 CRAMER, Jannette (CALLEN) 1,36
 John----- 1,36
 CRANE, Betty Sue (GLASS)- 3,241
 George C----- 3,241
 Julia----- 3,241
 CRANFORD, John W----- 3,134
 Nannie I (KIRKPATRICK)- 3,134
 Sarah KIRKPATRICK----- 3,120
 CRAWFORD, Eula (WILLIAMSON) 3,231
 Linda Sue GROSS----- 3,392
 Lenore (STEELE)----- 1,43
 Milton S----- 3,231
 Ruby Mae (BROWN)----- 3,314
 William----- 3,314
 CREIGHTON, Felix----- 3,162
 Georgia L (GLASS)----- 3,162
 CRONE, Susie KIRKPATRICK- 3,213
 CROOM, Buck----- 3,94
 Murel (PILQUIST)----- 3,94
 CRYTZER, Adelaïd R----- 1,168
 Florence SWEENEY----- 1,95
 Harmen----- 1,95
 Harry----- 1,95
 Harry Wood----- 1,95
 Ida (STEELE)----- 1,95
 Louise (ALLEN)----- 1,95
 Marcella----- 1,95
 Mary----- 1,95
 Richard----- 1,95
 Rosa D (WOOD)----- 1,95
 Virginia KALLENBORN---- 1,95
 William----- 1,95
 CULBERHOUSE, Mary McELWAIN 3,34
 CULVERHOUSE, Adele----- 3,88
 Allen D----- 3,279
 Alice E (DENNARD)----- 3,185
 Betty Jean----- 3,279
 Carolyn Louise----- 3,279
 E.A.----- 3,279
 Edward Gamble----- 3,185
 Elizabeth (FAHNESTOCK)- 3,88
 Elizabeth T CALLEN---- 3,19
 Eugen Callen----- 3,185
 Frances Eugenia----- 3,185
 Franklin----- 3,47
 Georgia----- 3,47
 Gertrude Elizabeth----- 3,88
 Grace----- 3,185
 Harry Hardee----- 3,88

CULVERHOUSE, John----- 3,47
 Katie R (BAYNE)----- 3,279
 Lizzie C CALLEN----- 3,31
 Lizzie T----- 3,47
 Mary Anne----- 3,47
 Thomas----- 3,47
 William----- 3,47
 William Callen----- 3,88
 William Edward----- 3,279
 CUMMINGS, Mary A (CHOATE) 3,15
 Thomas----- 3,15
 CUNNINGHAM, Alma (CALLEN) 4,42
 Ted----- 4,42

 DADY/DEADY, Ellen READ--- 3,92
 DAHLMAN, Mary R CALLEN--- 2,48
 DALE, Betsy A PURCELL---- 3,369
 DALEEP, Candace (CALLEN)- 1,181
 Michael----- 1,181
 DAMPIER, Wanda CALLEN--- 2,32
 DARBISON, Ella (COMPTON)- 3,197
 Henry----- 3,197
 Luella M CALLEN-TUSSY-- 3,197
 DAVIDSON, Gwen KIRKPATRICK 3,140
 Hugh----- 3,65
 Lucille (HORNADY)----- 3,65
 Margaret STAHLMAN----- 1,120
 DAVIS, Alford C----- 3,322
 Cecil----- 1,265
 Katie L TOLBERT----- 3,121
 Leonard W----- 3,24
 Lynda Mary CALLEN----- 1,265
 Matilda CALLEN----- 3,18
 Myrtle Mae PURCELL---- 3,182
 Ruthie WILLIAMSON----- 3,322
 Sarah E KIRKPATRICK---- 3,24
 DAWSON, Georgia (CALLEN)- 1,171
 Robert----- 1,171
 DAYTON, Virgie (CALLEN)-- 4,51
 DEADY/DADY, Ellen READ--- 3,92
 DEAN, Dennis----- 3,293
 Janie F CALLEN----- 3,293
 Martha (PERDUE)----- 3,60
 Mary Jane (TIPTON)----- 3,293
 Tabitha----- 3,118
 DeHART, Amanda Joe Anne-- 3,385
 Crystal Gall----- 3,385
 Sharon K (CALLEN)----- 3,385
 Tracy W----- 3,385
 Del REERE, Evelyn CALLEN- 4,68
 DENNARD, Alice CULVERHOUSE 3,185
 DENNIS, Ada Blanche WILLIAMSON 3,226
 Alsie WILLIAMSON----- 3,317
 George----- 3,317
 Letha (BENNETT)----- 3,317

DENNIS, Lillie V (ARNOLD) 3,226
 Mary M WILLIAMSON----- 3,131
 Mildred CALLEN----- 3,106
 William David----- 3,226
 DERBY, Eva (McCABE)----- 4,43
 Jessie----- 4,43
 Lura May HALTON----- 4,43
 Mary I CALLEN----- 4,22
 DessASSURE, Martha COLLINS 3,272
 DEWEY, Nellie A CALLEN--- 1,96
 DICKEY, David M----- 2,5
 Eliza J----- 2,5
 Elizabeth McBRYAR----- 2,7
 Emeline----- 2,5
 Eva Star M CALLEN----- 2,24
 DICKSON, Sarah O CALLEN-- 3,12
 DICKSY, James M----- 2,5
 John Andrew----- 2,24
 John M----- 2,5-2,23
 John T----- 2,5
 Mamy M (POWLEY)----- 2,24
 Margaret (CALLEN)----- 2,5-2,23
 Mary D BROSKI----- 2,5
 Rebecca P----- 2,5
 William----- 2,5
 DIDANITO, Mary A CALLEN-- 2,62
 DILBECK, Myrl Jr----- 3,293
 Tandra D (CALLEN)----- 3,293
 DILLON, Bonnie CALLEN---- 1,219
 DIMENTRAL, Charles Gilbert 2,36
 Dianna Lynn----- 2,55
 Evelyn (CALLEN)----- 2,36
 Ixchel Star----- 2,54
 DIMMOCK, Joan CALLEN---- 1,235
 DIXON, Eliza W (LAUGHLIN) 1,14
 James A----- 1,14
 John L----- 1,14
 Nancy J----- 1,14
 William----- 1,14
 DODD, Irena Mae CALLEN--- 4,31
 DODSON, Annie E CALLEN--- 1,75
 DOLBOW, Eunice C CALLEN-- 1,113
 DONALDSON, Dianne (CHAMBERS) 3,342
 Gary Leonard----- 3,342
 John Paul----- 3,342
 Nancy H (CALLEN)----- 3,28
 Vernelle D CALLEN----- 2,42
 William----- 3,28
 DOOL, Maude REYNOLDS---- 1,167
 DORCUS, Gen Frank----- 1,36
 Jean Cornelia (CALLEN)- 1,36
 DORSEY, Evans Smith----- 3,266
 Ruth Purcell (MURPHREE) 3,266
 DOTY, John Orval----- 4,82
 Lloyd----- 3,298
 Margie (CALLEN)----- 3,298

DOTY, Monty----- 3,298
 DOUGLAS, Kiziah----- 4,2
 Mary Elizabeth CALLEN-- 4,2
 Thomas----- 4,2
 DOVE, Luther B----- 3,125
 Minnie M (KIRKPATRICK)- 3,125
 Murray M----- 3,125
 DOWD, Mina Ree (CALLEN)-- 4,30
 DOWDA, Mary Idella CALLEN 3,58
 DOWLING, Sarah Y (BIRD)-- 1,92
 Wallace J----- 1,92
 DOWNING, Annie PICKENS--- 3,153
 DRAKE, Clarkie PURCELL--- 3,87
 DRAPER, Eula Ruth----- 4,36
 Leonard----- 4,36
 Myrtle Ira (CALLEN)---- 4,36
 Raleigh Edward----- 4,36
 Robert----- 4,36
 Willard Shelby----- 4,36
 DREIBELBIS, Karen WILLIAMSON 3,326
 DUBLIN, Thelma W SHAW---- 1,208
 DUFFER, Pearl (CALLEN)--- 1,72
 DUFFY/DUFFEY Margaret FOSTER 3,7
 DUNCAN, Lucinda (CALLEN)- 1,9
 DUNHAM, Lucille (STAHLMAN) 1,120
 DURR, James Judkins----- 3,361
 John W----- 3,361
 Lucy Powers----- 3,361
 Patricia P (COLLINS)--- 3,361
 DUSTIN, Deborah A CALLEN- 1,270
 DYE, Amy Lynn----- 1,257
 Cheri Lynn (CALLEN)---- 1,257
 Lyle Dean----- 1,257
 Margaret (CALLEN)----- 1,83
 EAKER, Carla----- 1,148
 Charles----- 1,148
 Charles "Johnnie"----- 1,148
 Clara (OVER)----- 1,148
 Rene----- 1,148
 Thomas----- 1,148
 EARLE, Gladys CALLEN---- 1,163
 EARLY, Sina CALLEN----- 1,63
 EBERHART, DeMaris CALLEN- 1,206
 EDGELL, Emma (CALLEN)---- 1,47
 Joseph----- 1,47
 EDINGTON, Carrie GEORGE-- 3,186
 Edith (MILLIGAN)----- 3,186
 James F----- 3,186
 EDISON, Margaret CALLEN-- 4,19
 EDMISTON, Kelly CALLEN--- 1,178
 ELLIOT, Jane E CALLEN---- 1,16
 ELLIOTT, Margaret CALLEN- 4,60
 Orpha CALLEN----- 4,37
 ELLISON, Elizabeth (CALLAN) 3,98

ELWELL, Donella CALLEN--- 1,261
 EMERSON, Loa M CALLEN---- 3,116
 EMERY, Grace GIBSON----- 1,193
 ESPY, Amarantha CALLEN--- 1,129
 ESTES, Norma R CALLEN---- 4,58
 ETTER, Ray GLASS----- 3,166
 EVANS, Jane CALLEN----- 4,3
 EVERSULL, Barnie Haden--- 3,127
 Bessie Kathleen (BUCKNER) 3,219
 Beverly Haden----- 3,219
 Elizabeth MEREDITH-KELLEY 3,313
 Jewell E (KIRKPATRICK)- 3,127
 Kathleen (BUCKNER)----- 3,130
 Lucille (HARRIS)----- 3,219
 Ruthann A (O'QUIN)----- 3,127
 Virgie Lee JARRETT----- 3,218
 William F----- 3,127
 William F----- 3,86
 EWALT, Lee CALLEN----- 4,79
 Tami----- 4,79
 EZELL, Barbara G BUTLER-- 3,401
 Mary Gene (WALTERS)---- 3,356
 Norma Joe JORDAN----- 3,402
 Robert E----- 3,356

FAHNESTOCK, E CULVERHOUSE 3,88
 FALKENBERRY, Eleanore (RENNIE) 3,263
 Florence (KNIGHT)----- 3,263
 Roswell L----- 3,263
 FARIS, Laura ABERNATHY--- 3,269
 FENNEL, Sadie N CALLEN--- 1,73
 FINEFROCK, Edward----- 1,149
 Harold----- 1,149
 Ruth (OVER)----- 1,149
 FISCUS, Carol Jean----- 1,139
 Cheryl Joy----- 1,139
 Clair Wilson----- 1,139
 Elsie (CALLEN)----- 1,51
 Nellie Irene (CALLEN)-- 1,139
 Robert Lee----- 1,139
 Walter J----- 1,51
 FLEMING, Augusta (BELDING) 1,105
 Charles Ryker----- 1,174
 Elizabeth CALLEN----- 1,8
 Harriett (KNOX)----- 3,364
 Hugh Belding----- 1,105
 James----- 1,8
 Jane HOLLER----- 1,8
 Janet (ROBERTS)----- 1,175
 Kathryn----- 1,174
 Kathleen Byrnece----- 3,364
 Kevin Knox----- 3,364
 Lawrence Belding----- 1,105
 Linda----- 1,175

FLEMING, Robert----- 1,174
 Russel----- 1,175
 Sidney Stetson III----- 3,364
 Stetson Austin----- 3,364
 Willis M----- 1,105
 FLEMMING, Alpheus----- 1,134
 Betty CAIN----- 1,134
 Betty (SCHUMAN)----- 1,134
 Bill----- 1,134
 Twyla O (CALLEN)----- 1,134
 FLOYD, Jane (CALLEN)----- 3,12
 John M----- 3,12
 FLUKER, Graham----- 3,162
 Rebecca E (GLASS)----- 3,162
 FLYNN, Grace CALLEN----- 1,79
 FORD, Amanda Jo Anne----- 3,385
 Cody George----- 3,385
 Crystal Gail----- 3,385
 George Alpha----- 3,385
 Kathleen W CALLEN----- 1,184
 Sharon Kay (CALLEN)---- 3,385
 FORINGER, Francis CALLEN- 1,57
 FORTENBERRY, Mary SLAYTON 3,282
 FOSTER, Albert----- 1,231
 Elizabeth W CALLEN----- 3,7
 Jody----- 1,231
 John----- 1,231
 Margaret (DUFFY)----- 3,7
 Mary Beth (LIVENGOOD)-- 1,231
 Mary Clarinda CALLEN--- 4,35
 Robert----- 3,7
 FOWLER, Fred----- 1,97
 Iona Barbara (CALLEN)-- 1,97
 Rosemary PURCELL----- 3,367
 FOX, Elizabeth SHADLE--- 1,17
 FRANKS, Stella CALLEN--- 3,110
 FRANTZ, Nancy (McCONAHAY) 4,65
 Olive (RAYBURN)----- 1,19
 William----- 1,19
 FRAZIER, Frankie HART--- 3,199
 FREDERICK, Rose CALLEN--- 1,269
 FREEMAN, Mary C CALLEN--- 1,32
 FREY, Bessie (PICKENS)--- 3,152
 FRIZBEE, Susan SIMMONS--- 1,238
 FULLER, Catherine TINSLEY 3,63
 Paulette CALLEN----- 1,235
 FULTZ, Harriett WOODSON-- 3,261
 Kelton Benton----- 3,261
 Sue Carol PROOS----- 3,261
 FUNDERBURK, Calla (GEORGE) 3,220
 M.L.----- 3,220
 Mary (BROWN)----- 3,220
 FURLONG, Emma (WILLIAMS)- 3,165
 FURY, Regina B CALLEN--- 1,117

GALATI, Kathleen (GILLIGAN) 1,191
 GALBRAITH, Eliza----- 1,6
 Ester (MILLEN)----- 1,20
 James C----- 1,20
 Jane Callen----- 1,18
 John Jr----- 1,6
 John Sr----- 1,6
 Joseph----- 1,6
 Mary "Polly" (CALLEN)-- 1,6
 Mary----- 1,6
 Rebecca (SMITH)----- 1,6
 Robert----- 1,6
 Sarah----- 1,6
 GALLATIN, Juanita CHAMBERS 3,337
 GANDY, Georgia B (CALLEN) 3,78
 Hampton----- 3,30
 R.E.----- 3,78
 Rebecca Elefair CALLEN- 3,30
 GARD, Norma J SLAYTON---- 3,373
 GARNER, Mary Jane CALLEN-- 2,17
 GARRETT, Minnie GLASS---- 3,160
 GARVER, Sarah RAYBURN---- 1,19
 GARYSON, Mildred CALLEN-- 2,28
 William E----- 2,28
 GEARY, Orlo W----- 1,43
 GENTRY, Alice MUNDAY---- 3,316
 GEORGE, Adeline Elizabeth- 3,50
 Alexander----- 3,14
 Alexander Andrew----- 3,50
 Amanda E (GOODWIN)---- 3,90
 Anna Adeline----- 3,14
 Arthur----- 3,186
 Calla FUNDERBURK----- 3,220
 Carrie (EDINGTON)----- 3,186
 Elizabeth (CALLEN)---- 3,14
 Georgia Ann----- 3,50
 Guelda (JOHNSON)----- 1,176
 Hosia Halcum----- 3,90
 James Callen----- 3,50
 Jenece Lynn "Jenny"---- 1,176
 John----- 1,176
 John Callen----- 3,90
 Johnna Berthelle----- 1,176
 Lucinda Davis----- 3,14
 Lucinda (HUTCHESON)---- 3,50
 Major Arthur----- 3,186
 Margaret Alice----- 3,50
 Mary Jane (PIKE)----- 3,89
 Mary Lucinda HARRISON-- 3,187
 Muriel Marie SMITH----- 3,280
 Priscilla Elizabeth---- 3,50
 Tommy John Blake----- 1,176
 William Andrew----- 3,50
 William Stewart (1854)- 3,89
 William Stuart (1878)-- 3,90
 GIBSON, A. Roy----- 1,193

GIBSON, Grace (EMERY)---- 1,193
 Olive Louise CALLEN---- 1,193
 GILES, Herman----- 3,223
 Josinell (BROWN)----- 3,223
 GILL, Arlie KIRKPATRICK-- 3,137
 GILLETTE, Elizab (KIRKPATRICK) 3,24
 Morris----- 3,24
 GILLIGAN, Kathleen GALATI- 1,191
 Mary Alice MOSES----- 1,191
 Mary E "Betty" (CALLEN)- 1,191
 Samuel Anderson----- 1,191
 GILMER, Ada L (CALLEN)--- 3,82
 Beatrice----- 3,82
 Beverly----- 3,262
 Eugene Theodore----- 3,84
 Eugenia----- 3,82
 Eugenia F (CALLEN)---- 3,84
 James M Jr----- 3,262
 James M Sr----- 3,176
 Hamilton Harris----- 3,84
 Harris Lewis----- 3,82
 Marie----- 3,176
 Marion D "Pete"----- 3,82
 Mary Ann (CALLEN)----- 3,33
 Sarah A HARRIS----- 3,38
 William James----- 3,82
 William M----- 3,33
 GLADFELTER, Tamsay (CALLEN) 4,8
 GLASS, Albert Ross----- 3,160
 Annie Gertrude TATMAN-- 3,167
 Betty Sue CRANE----- 3,241
 Birdie Lorain NICKLAS-- 3,250
 Braxton Garret----- 3,333
 Carol M MURRAY-PRATT--- 3,332
 Charles Norwood----- 3,253
 Charles Robert----- 3,168
 Clarence Alexander (1883) 3,166
 Clarence Alexander (1920) 3,260
 Claude L (GRANT)----- 3,160
 Cynthia Lynn RICH----- 3,351
 Dorothy Dale RALPH----- 3,251
 Dorothy (HOLLAND)----- 3,160
 Edna Earl (LAMBERT)---- 3,244
 Effie (GOLSON)----- 3,157
 Eileen (KELLY)----- 3,158
 Eileen (SPILLER)----- 3,158
 Elaine CLARK----- 3,247
 Ellen V (BROWN)----- 3,253
 Emma (WILLIAMS)----- 3,165
 Eugenia Ellen THOMAS--- 3,243
 Eva Eulala COOK----- 3,164
 Floretta CLARK----- 3,248
 Folsom Lamont----- 3,163
 Frances (TAYLOR)----- 3,159
 Frederick Elmer----- 3,165
 Garnett Callen (1888)-- 3,162

GLASS, Garnett Callen(1919) 3,162
 Georgia Louise CREIGHTON 3,162
 Gladys----- 3,242
 Ida Evelyn----- 3,70
 Irene Eugenia WOODSON-- 3,173
 James Frances----- 3,159
 James Malcolm----- 3,242
 Jeannine----- 3,242
 Jill (WILKERSON)----- 3,333
 Jimmie----- 3,242
 Joe Louis----- 3,259
 Joe Louis, Jr----- 3,352
 John Leonidas----- 3,157
 Johnnie L----- 3,157
 Jonell (SEALE)----- 3,259
 Joseph----- 3,244
 Joseph Edward----- 3,160
 Joseph Ross----- 3,160
 Julia (BELL)----- 3,158
 Kellie (KIRKPATRICK)--- 3,352
 Lillie (KERN)----- 3,163
 Linda Ann MEGAN----- 3,334
 Linda Lou WOODMAN----- 3,254
 Loyd B (WOOD)----- 3,159
 Lucian Presley----- 3,69
 Margaret F (CALLEN)---- 3,29
 Margaret Louise STRAUSS 3,174
 Mary Alice JOHNSON----- 3,252
 Mary E R (SHEPPARD)---- 3,70
 Mary Eula (MORGAN)---- 3,168
 Mattie Leora NICELY---- 3,169
 Minnie M (BETTS)----- 3,172
 Minnie M (GARRETT)---- 3,160
 Nancy Ellen----- 3,335
 Nodie Rebecca----- 3,159
 Orin (MCLEOD)----- 3,158
 Oliver McKee----- 3,71
 Ray (ETTER)----- 3,166
 Rebecca A PRESLEY----- 3,161
 Rebecca E FLUKER----- 3,162
 Rebecca Carolyn WARREN- 3,258
 Rebecca Jane RAY----- 3,350
 Rebecca (TILLERY)----- 3,69
 Rena Leigh ROBINSON---- 3,240
 Robert Julius----- 3,158
 Robert Malcolm (1878)-- 3,69
 Robert Malcolm (1921)-- 3,244
 Robert William Alexander 3,29
 Ross Callen----- 3,69
 Ruby M (HOLLINGSWORTH)- 3,253
 Rue Ann----- 3,336
 Sarah----- 3,242
 Stella Arboree (AMIS)-- 3,171
 Sturgeon Foster----- 3,158
 Sturgeon Foster (1913)- 3,158
 Tommie Earl----- 3,260

GLASS, Velma Sheppard---- 3,170
 Vera (OLIVE)----- 3,162
 Vincent Bell----- 3,158
 Wicker Ira----- 3,171
 William James Foster--- 3,70
 William Oliver----- 3,69
 William Oscar Mulkey--- 3,162
 William Ralph----- 3,172
 William Ross----- 3,159
 Zyle Rush----- 3,333
 GLICK, Fannie B CALLEN--- 4,51
 GOFF, Endil "Peggy"(CALLEN) 2,40
 Robert Jr----- 2,40
 GOLSAN, Rebecca ZEIGLER-- 3,68
 GOLSON, Bessie CALLEN--- 3,39
 Effie GLASS----- 3,157
 GOODENOUGH, Mary CALLEN- 1,26
 GOODLOE, Georgia (CALLEN) 2,27
 Oscar----- 2,27
 GOODMAN, Ida CALLEN----- 3,107
 Margaret CHAMBERS----- 3,343
 GOODWIN, Amanda E GEORGE- 3,90
 GOULD, Marjorie D CALLEN- 1,164
 GRABASY, Josephine (CALLEN) 1,192
 Stanly----- 1,192
 GRANGER, Margurete JACKSON 3,228
 GRANT Claude L GLASS---- 3,160
 GRAY, Caroline PURCELL--- 3,276
 Donna CALLEN----- 4,70
 Francis N (CALLAN)---- 3,97
 George----- 3,97
 Mary TORRANCE----- 2,6
 Vadus----- 3,97
 GRAYSON, Mildred (CALLEN) 2,31
 William E----- 2,31
 GREEN, Jennifer McCRARY-- 4,83
 Naomi COLE----- 2,30
 GREENO, Ronald L----- 2,30
 Virginia May (CALLEN)-- 2,30
 GREER, George A----- 2,22
 Hanna (TORRENCE)----- 2,22
 GREGG, Sandra (TOWNSEND)- 1,197
 GRESHAM, Martha KIRKPATRICK 3,6
 GRIEF, Catherine CALLEN-- 1,22
 GRIFFIN, Gayelynn CALLEN- 3,310
 GRIFFITH, Janice S CALLEN 2,59
 Marjorie CHAMBERS----- 3,338
 GRISSUM, Bollie----- 3,113
 Essie (CALLEN)----- 3,113
 Mary Louise----- 3,113
 Maurice----- 3,113
 GRIZZLE, Danny George---- 3,178
 Gene Austin----- 3,178
 Georgia M (MILLS)----- 3,178
 Harriett "Linda" (BARNES) 3,264
 Jerry Garland----- 3,178

GRIZZLE, Martha Augusta-- 3,178
 Randy Joe----- 3,178
 William Austin----- 3,178
 GROB, Ottillia A CALLEN-- 1,83
 GROOKETT, Jane SHAW----- 1,209
 GROSS, John Walter William 3,392
 Linda Sue (CRAWFORD)--- 3,392
 Mariana Christina----- 3,392
 Pablo Juan Max----- 3,392
 Stacy Nicole----- 3,392
 GRUVER, Mary M CALLEN---- 1,53
 GUICE, Bessie R (PICKENS) 3,152
 Judith----- 3,239
 Ruth (REICHEL)----- 3,239
 Taylor----- 3,152
 Taylor Jr----- 3,239

HADDAD, Nancy CALLEN----- 4,77
 HALL, Rhonda W CALLEN---- 1,282
 Susan L (CALLEN)----- 1,190
 HALTON, Lura M (DERBY)--- 4,43
 HAMILTON, Isaac----- 1,8
 Nancy CALLEN----- 3,111
 Sarah (CALLEN)----- 1,8
 HANES, Neva CALLAN----- 3,191
 HARGIS, Richard E----- 2,30
 Suzanne Marie (CALLEN)- 2,30
 HARDMAN, Dorothy S KNOX-- 3,365
 HARKRADER, Chase Alan--- 3,387
 Gary J----- 3,387
 Sherrie L (SULLIVAN)--- 3,387
 HARMON, Eunice E CALLAN-- 3,190
 HARRELL, Lucille (CALLEN) 3,42
 HARRIGER, Hattie (CALLEN) 1,50
 HARRIS, Eugenia F CALLEN- 3,38
 Lucille EVERSULL----- 3,219
 Melville----- 3,38
 Sarah A (GILMER)----- 3,38
 HARRISON, Bessie Mae---- 3,187
 Carl Frederick----- 3,187
 Clyde Millard----- 3,187
 Gladys E ADAIR----- 3,281
 J.R.----- 3,291
 James Luther----- 3,187
 Joann CALLEN----- 3,291
 John Louis----- 3,187
 Lola Wilma----- 3,187
 Mary Lucinda (GEORGE)-- 3,187
 Noel Winfred----- 3,187
 Ruth B (HOBBIE)----- 3,291
 William Clarence----- 3,187
 William Henry----- 3,187
 Zelma Lucinda----- 3,187
 HART, Anna W CALLEN----- 3,199
 Frankie (FRAZIER)----- 3,199

HART, Richard S----- 3,199
 HARTLEY, Judith N CALLEN- 2,52
 HARVEY, Martha ABERNATHY- 3,357
 HARWELL, John----- 3,288
 Juna K (WARREN)----- 3,288
 Kay----- 3,288
 Lee----- 3,288
 HASKELL, Dexter----- 1,8
 Ellen (CALLEN)----- 1,8
 HASLEY, Nettie (CALLEN)-- 1,36
 HASTON, Odel V McCRAV---- 3,195
 HATE, Annie CALLEN----- 2,17
 HAYES, Elizabeth (NIGH)-- 3,380
 Lillard Cody----- 3,380
 HAYS, Caroline (CALLEN)-- 4,17
 Ethel (WELSH) CALLEN--- 4,52
 Lementine America CALLEN 4,15
 Samuel A----- 4,17
 HEDLREND, Beverly CALLEN- 4,81
 HELD, Jacquilyn CALLEN--- 2,60
 HENDERSHOT, Kenneth W---- 3,374
 Linda (CALLAN)----- 3,374
 Ronald L----- 3,374
 Ronald Lee II----- 3,374
 HENDERSON, David Holloway 1,118
 Elizabeth (HOTTEL)----- 1,118
 Josephine CALLEN----- 1,118
 HENDRICKS, Emily CALLAN-- 3,284
 HENLEY, Anita M CALLEN--- 4,58
 HENNEN, David----- 1,1
 James----- 1,1
 Sarah CALLEN----- 1,1
 HENRY, Bessie CALLEN---- 1,70
 Helen CALLEN----- 1,145
 HEPLER, Goldie A CALLEN-- 1,128
 HEROD, Carl----- 1,160
 Velma A (CALLEN)----- 1,160
 HIATT, Ellen CALLEN----- 4,29
 Oren A----- 4,29
 HICKS, Fern Leah CALLEN-- 1,155
 Joseph----- 3,227
 Louisiana (TINSLEY)--- 3,132
 Martha (BENNETT)----- 3,227
 Thelma WILLIAMSON----- 3,227
 William Henry----- 3,132
 HIGGINBOTHAM, Dixie JOHNSON 3,295
 HILTON, Elzadie CALLEN--- 4,20
 HINE, Elizabeth TOWNSEND- 2,6
 HINMAN, Dorothy (CALLEN)- 2,53
 John Robert----- 2,53
 HIXON, "Jack"----- 3,368
 Joan Alice (PURCELL)--- 3,368
 HOBBIE, Ruth B HARRISON-- 3,291
 HODGES, Grace (TOLBERT)-- 3,121
 HOLBEN, Muriel R (BIRD)-- 1,167
 Randon E----- 1,167

HOLDMAN, Joan----- 1,265
 HOLLAND, Dorothy GLASS--- 3,160
 HOLLER, Jane (FLEMING)--- 1,8
 Mary Rebecca CALLEN---- 1,24
 Samuel----- 1,8
 HOLLINGER, Bobbie (ANTILLEY) 3,327
 Daniel Lee----- 3,327
 Keneth Wayne----- 3,327
 William----- 3,327
 HOLLINGSWORTH, Debbie (CALLEN) 4,81
 Gary----- 4,81
 Ruby GLASS----- 3,253
 HOLMES, Alma D (CALLEN)-- 4,42
 Billy Dean----- 4,42
 Earnest Winton----- 4,42
 Fred----- 4,42
 Irene CALLEN----- 3,108
 Janet June----- 4,42
 Orvetta CALLEN----- 3,106
 HOLTON, Izella (STRICKLAND) 3,64
 Letsy A KIRKPATRICK---- 3,64
 Minnie Edna KIRKPATRICK 3,122
 William Amos----- 3,64
 HONEYCUTT, Minnie KIRKPATRICK 3,126
 HONSWALT, Judy CALLEN---- 4,64
 HOOKS, Arthur----- 3,44
 Charles Lafayette----- 3,44
 Dezzie Lee----- 3,44
 Dorcas (CALLEN)----- 3,10
 Dorcas M MILLS----- 3,86
 Fariest Alexander----- 3,44
 Frances Jane----- 3,44
 Jane----- 3,10
 John Robert----- 3,44
 John Ross----- 3,10
 Julius Alexander----- 3,44
 Julius Leo----- 3,44
 Manerva Harris----- 3,10
 Marcus Monroe----- 3,10
 Mary E (WILHELM)----- 3,44
 Whitmell----- 3,10
 Mary Olive----- 3,44
 Owen Columbus----- 3,10
 W Lafayette----- 3,10
 HORN, Miss CALLEN----- 3,45
 HORNADY, Bertha D JONES-- 3,144
 Ethel WINDHAM----- 3,65
 George----- 3,26
 Henry C----- 3,141
 Hermione THOMAS----- 3,65
 Ida (CHEATHAM)----- 3,65
 Inee BOWEN----- 3,142
 J William----- 3,26
 Jack----- 3,143
 John----- 3,26
 Lizzie----- 3,26

HORNADY, Lucille DAVIDSON 3,65
 Minnie (HUDSON)----- 3,65
 Sarah (KIRKPATRICK)---- 3,26
 Streety----- 3,65
 Theo----- 3,65
 William M----- 3,65
 Willie Cliff----- 3,143
 Willie Cliff Jr----- 3,143
 HORNBEAK, E.M.----- 3,36
 Nancy S (CALLEN)----- 3,36
 HOTTEL, Elizabeth (HENDERSON) 1,118
 HOUSER, Sue REED----- 3,306
 HOWARD, Helen P CALLEN--- 2,45
 HOWELL, Bertha PICKENS--- 3,148
 HOWRY, Lillian M CALLEN-- 4,27
 HUBER, Jeanne S (CALLEN)- 2,56
 HUDDLESTON, Beth Ann----- 3,390
 Teresa (CALLEN)----- 3,390
 Walter Ray----- 3,390
 HUDSON, Amy Elizabeth---- 3,399
 Elizabeth M (WALTERS)-- 3,399
 Minnie HORNADAY----- 3,65
 Raymond Paul----- 3,399
 William Raymond II----- 3,399
 HUEY, Josephine CALLEN--- 4,62
 HUFF, Frances----- 3,53
 Nancy J CALLEN----- 3,53
 William L----- 3,53
 Willie A BIGGERS----- 3,103
 HUFFMAN, Oliver Ross----- 3,151
 Pearl Lillian (PICKENS) 3,151
 W H "Bill"----- 3,151
 HUGHES, Cora Bell THOMAS- 2,33
 HULL, Lorene (JACKSON)--- 3,228
 Rayburn----- 3,228
 HUMPHREYS, Bertha (BIRD)- 1,88
 Evelyn Luella----- 1,88
 Frances Lucille----- 1,88
 Harry Baird----- 1,88
 Irene Bird----- 1,88
 Kenneth Elwood----- 1,88
 Marshall B----- 1,88
 Mary Luella (BIRD)----- 1,90
 Nellie May----- 1,88
 Victor, Dr----- 1,90
 HUNTER, Emeley (CALLEN)-- 2,1
 HUTCHESON, Hezekiah----- 3,50
 Lucinda GEORGE----- 3,50
 HUTCHISON, Missouri KNIGHT 3,85

 ILER, Mary E Nelson----- 2,31
 INGLING, Elizabeth (CALLAN) 3,193
 Thomas----- 3,193
 INGRAM, Margaret CALLEN-- 4,7
 IRWIN, Barbara (CHAMBERS) 3,341

IRWIN, Dollma (CALLAN)--- 3,99
 Kathleen Regina----- 3,341
 Melanie Mae----- 3,341
 Thomas Peter, Jr----- 3,341
 Virgil----- 3,99

 JACKSON, Alice----- 3,228
 Allen W----- 3,222
 Allie Carroll (MURPHREE) 3,267
 Charlotte B WALDING---- 3,323
 Ellen H (CALLEN)----- 3,41
 F Effie (WILLIAMSON)--- 3,228
 Fred----- 3,41
 Hugh C----- 1,9
 James Edgar----- 3,228
 James Wesley----- 3,228
 Jessie Edgar----- 3,228
 Lorene HULL----- 3,228
 Margurete (GRANGER)---- 3,228
 Martha Ellen BENNETT--- 3,225
 Mary Ann CALLEN----- 1,9
 Mary Ann (CALLEN)----- 1,9
 Mary Lou CALLEN----- 3,42
 Raymond Clinton----- 3,228
 Sarah S (BROWN)----- 3,222
 Sid----- 3,267
 William----- 1,9
 JACOBS, Charlotte JOHNSON 3,330
 JARRETT, Beverly Jane--- 3,218
 Emmett Davis----- 3,218
 Emmett Davis Jr----- 3,218
 Virgie L (EVERSULL)---- 3,218
 JELKEN, Alvin----- 3,236
 Juanita (KIRKPATRICK)-- 3,236
 JENKIN, Blanche M CALLEN- 2,28
 Eva (PATTERSON)----- 2,28
 Jess----- 2,28
 JENSEN, Anna (SCHACK)---- 1,110
 Henriette F CALLEN----- 1,110
 Soren M----- 1,110
 JEWELL, Doris CALLEN---- 1,162
 JOHNSON, Albert J "Bert"- 1,112
 Blufford----- 3,198
 Charlotte (JACOBS)---- 3,330
 Dede----- 3,295
 Dixie (HIGGINBOTHAM)--- 3,295
 Donna Gaye----- 3,330
 Elvira CALLEN----- 3,54
 Guelda GEORGE----- 1,176
 Gypsy Lee----- 3,198
 Hattie Belle (CALLEN)-- 1,112
 Hickman O----- 3,233
 Hiedi CALLEN----- 4,71
 James David----- 3,330
 James Pinkney----- 3,252

JOHNSON, Marlon----- 3,295
 Martha Lynn JONES----- 3,331
 Mary Alice (GGLASS)---- 3,252
 Mary Lea (RHEA)----- 3,389
 Nicholas----- 3,295
 Olivia Ann----- 3,330
 Ona (CALLEN)----- 3,198
 Randel----- 3,295
 Tanya----- 3,198
 Vonnie V (KIRKPATRICK)- 3,233
 Wendy----- 3,295
 JONES, Allie (MURPHREE)-- 3,267
 Bentley----- 3,95
 Bertha Dolly (HORNADY)- 3,144
 "Betty" F (CALLEN)---- 1,129
 C Donnis (CALLAN)----- 3,95
 Carol Lee----- 1,207
 Clara----- 3,95
 Darlene Bertha (CALLEN) 1,251
 Dell----- 3,95
 F Hinds----- 3,144
 George----- 3,95
 John Alan----- 3,331
 John Gordon----- 3,331
 "JR" John Robert Jr---- 1,251
 John Robert Sr----- 1,251
 Martha L (JOHNSON)---- 3,331
 Mary Elizabeth SHAW)--- 1,207
 Mary WILLIAMS----- 3,177
 Michael Wayne----- 3,331
 Nancy ALBERTSON----- 4,22
 Robert Hamilton----- 3,267
 Robert J----- 1,129
 Rowland----- 1,207
 Syble----- 3,95
 JORDAN, Caroline Denise-- 3,402
 Christopher Brent----- 3,402
 Hiram Ray----- 3,402
 Norma Jo (EZELL)----- 3,402
 Pauline CALLEN----- 1,194

 KALLENBORN, John----- 1,95
 Virginia (CRYTZER)---- 1,95
 KARR (see KERR)
 KELLEY, Charles----- 3,313
 Elizabeth A (EVERSULL)- 3,313
 KELLOGG, Gladys ANDERSON- 1,173
 KELLY, Eileen GLASS----- 3,158
 KELSELL, Tammie CALLEN-- 4,75
 KENNEDY, Elizabeth (SIMPSON) 3,8
 Elizabeth Harvey CALLEN 3,11
 Hugh E----- 3,8
 Nancy S CALLEN----- 3,8
 KENYON, J.B.----- 4,15
 Louella J (CALLEN)---- 4,15

KERLE, Doris CALLEN-----	1,221	KIRKPATRICK, Gladys McCRANEY	3,234
KERN, Lillie GLASS-----	3,163	Gwendolyn (DAVIDSON)---	3,237
KERNS, Cynthia (RAYBURN)-	1,22	Harriet A-----	3,9
Darius P-----	1,22	Ida Bell-----	3,43
KERR, Catherine CALLEN---	1,188	Indo Alice-----	3,27
Nancy Agnes CALLEN-----	3,2	Irma H (LARRAIMER)-----	3,138
KERRY, Carrie A (CALLEN)-	1,36	Isadore-----	3,66
William-----	1,36	James Fisher-----	3,122
KERSEY, Katherine CALLEN-	3,93	James M-----	3,9
KETTEN, Melba CALLAN-----	3,286	Jane M (PIERCE)-----	3,123
KEYS, Martha Jean SILVES-	1,203	Jane Peake WALL-----	3,215
KIENTZ, Andy-----	2,58	Jessie PETTIS-----	3,145
Kevin-----	2,58	Jewell Edna EVERSULL---	3,127
Kimberly Ann-----	2,58	Joan-----	3,27
Mary Ann (CALLEN)-----	2,58	Joe B-----	3,66
KIESEWETTER, Barbara (SOUZA)	1,223	John C-----	3,6
KILEY, Anna Marie CALLEN-	1,195	John C (1891)-----	3,66
KING, Annie CALLEN-----	1,67	John Thomas (1846)-----	3,62
Georgia Rose CALLEN-----	2,51	John Thomas (1875)-----	3,62
John W-----	3,128	John Tuck-----	3,235
John W MITCHELL-----	3,128-3,124	Johnathan Cervantes---	3,66
Mamie L (KIRKPATRICK)--	3,128	Julia L ROW-----	3,135
KINNEY, Hazel J CALLEN---	1,181	Juanita JELKEN-----	3,236
KIRBY, Elizabeth (MORRSEY)	2,25	Kellie Jeanne GLASS----	3,352
John "Jack"-----	2,25	Laird-----	3,9
Ollie May CALLEN-----	2,25	Leah Loucetta-----	3,139
KIRKPATRICK, Alexander M-	3,61	Letsey Adarine (HOLTON)	3,64
Alice Olive Snowden----	3,43	Louis Van Dorn-----	3,119
Amanda E-----	3,9	Louise (BRIDENALL)-----	3,237
Ann (1840)-----	3,24	Lucy Moore (CARRUTH)---	3,138
Archie (GILL)-----	3,137	Luther E-----	3,66
Augustus Crittenden----	3,64	Lydia (TOLBERT)-----	3,119
Caroline CAMPBELL-----	3,24	Malena Smyley KNIGHT---	3,85
Caroline J BERTRAM-----	3,216	Mamie Lee KING-----	3,128
Caroline (WILLIAMSON)--	3,62	Margaret C WETZEL-----	3,213
Carolyn Darden SMITH---	3,215	Margaret F (CALLEN)---	3,29
Carrie O (ASHMORE)-----	3,140	Margaret "Maude" PIERCE	3,124
Clara F (RAHAM)-----	3,43	Martha PARKER-----	3,24
Claudia Ione-----	3,43	Martha (GRESHAM)-----	3,6
Corrine (BROWNING)-----	3,235	Martha (McMURRAY)-----	3,6-3,9
David Edgar-----	3,237	Martha M PHILLIPS-----	3,25
David Malcolm "Pete"---	3,213	Mary (BILL)-----	3,27
Davidson Kerr-----	3,213	Mary Ellen WATSON-----	3,146
Dewitt Talmadge-----	3,126	Mary Jane (BLACKWELL)--	3,61
Eleanore A-----	3,9	Mary S.M.-----	3,9
Elizabeth (CALLEN)-----	3,6	Mary Sellers (McCURDY)-	3,9
Elizabeth GRILLETTE---	3,24	Milton-----	3,9
Elizabeth Sarah-----	3,9	Minnie (BOYD)-----	3,136
Ella Maude SKEELES-----	3,214	Minnie (HOLTON)-----	3,122
Ena Lee (TAYLOR)-----	3,213	Minnie (HONEYCUTT)-----	3,126
Eugene Emerson-----	3,137	Minnie Maybell DOVE---	3,125
Eugenia TOLBERT-----	3,121	Nan Pierce LUKMIRE-----	3,215
Frances A TINSLEY-----	3,63	Nancy (CALLEN)-----	3,9
Francis-----	3,6	Nancy PERDUE-----	3,23
Francis Edward-----	3,67	Nannie Izalla CRANFORD-	3,134
George Alexander-----	3,27	Nannie L.G. (PEAKE)----	3,215

KIRKPATRICK, Narcissus TANNER 3, 24
O. Monroe----- 3, 9
Pattie Ruth MONK----- 3, 238
Pauline----- 3, 140
"Pete" David Malcolm--- 3, 213
Raleigh Crittenden----- 3, 215
Rodney Harold----- 3, 217
Robert H----- 3, 29
Robert Pinkney----- 3, 135
Rollie Crittenden----- 3, 123
Roscoe----- 3, 64
Ruby T (PECK)----- 3, 235
Russell W----- 3, 66
Samantha (WOOD)----- 3, 67
Samuel Alexander----- 3, 24
Samuel Augustus----- 3, 120
Samuel McCurdy----- 3, 9
Sarah (CRANFORD)----- 3, 120
Sarah E (DAVIS)----- 3, 24
Sarah E HORNADY----- 3, 26
Solomon Edgar----- 3, 140
Solomon Edgar, Jr----- 3, 237
Susan C ROGERS----- 3, 213
Susie M (CRONE)----- 3, 213
Thelma Ione----- 3, 122
Trenton Crittenden----- 3, 138
Valentine----- 3, 6
Valentine----- 3, 9
Valentine (1830)----- 3, 27
Vonnie V JOHNSON----- 3, 233
Walter----- 3, 27
William Laird----- 3, 43
William Pinkney----- 3, 24
Willie Augustus----- 3, 136
KISKADDEN, Elizabeth----- 1, 10
Isabella----- 1, 10
Mary----- 1, 10
Thomas----- 1, 10
KNIGHT, Clara (WILLIAMS)- 3, 177
Claude Kirkpatrick----- 3, 177
Claude Kirkpatrick, Jr- 3, 177
Florence (FALKENBERRY)- 3, 263
John T----- 3, 85
Joseph----- 3, 85
Joseph Kirkpatrick----- 3, 263
Joseph Sturdevant----- 3, 263
Kay MARTIN-BOWLEY----- 3, 353
Malena Claire----- 3, 85
Malena S (KIRKPATRICK)- 3, 85
Missouri (HUTCHISON)--- 3, 85
Vickie E TAYLOR----- 3, 354
KNOX, Davis Purcell----- 3, 365
Dorothy S (HARDMAN)--- 3, 365
Dorothy Shell----- 3, 365
Harriett E FLEMING----- 3, 364
John Hardman----- 3, 365

KNOX, Lizzie----- 3, 26
Thelma B (PURCELL)----- 3, 274
William----- 3, 26
Wyckliffe Austin----- 3, 274
Wyckliffe Austin, Jr--- 3, 365
Wyckliffe Austin III--- 3, 365
KRIEBEL, Arlene BAILEY--- 1, 264
KROPP, Myra CALLEN----- 3, 299
Veronica CALLEN----- 3, 297
LaBORDE, Roberta (CALLEN)- 1, 201
LACY, Carl----- 1, 121
Edna----- 1, 121
Ellen----- 1, 121
Juanita----- 1, 121
Ruth----- 1, 121
Sarepta J (CALLEN)----- 1, 56
LaFOND, Barbara (CALLEN)- 1, 241
Donald----- 1, 241
LAIRD, Dorothy B (CALLEN) 2, 53
John Robert----- 2, 53
LAMB, Martha E CALLEN---- 1, 54
LAMBERT, Edna E GLASS---- 3, 244
LANDRETH, Malinda CALLEN- 2, 14
LANHAM, Billie CALLAN---- 3, 193
LARGE, Donald----- 3, 376
Jessica Michelle----- 3, 376
Michael Brandon----- 3, 376
Rebecca S (CALLAN)----- 3, 376
LARRAIMER, Irma KIRKPATRICK 3, 138
LASH, Eliza (REICHART)--- 1, 30
Urbana Callen----- 1, 30
William P----- 1, 30
LASHLEY, Averil (COLLINS) 3, 359
Donald W----- 3, 359
Peter Stewart----- 3, 359
Sarah Brooke----- 3, 359
LATHROP, Barbara (CALLEN) 1, 162
LAUGHLIN, Eliza CALLEN--- 1, 14
LAUVE, Beverly L TREMONT- 3, 398
Donald Beverly----- 3, 320
L Francis (WILLIAMSON)- 3, 320
Melanie Diane----- 3, 320
Sherry TAYLOR----- 3, 397
LAWLEY, Bradley----- 3, 391
Claud----- 3, 201
Christa----- 3, 301
Debra (POWELL)----- 3, 391
Donna (CALHOUN)----- 3, 302
Gary----- 3, 301
Gregg----- 3, 301
Jay----- 3, 301
Jerry----- 3, 302
Jerry Lynn Jr----- 3, 391
Pat (THOMPSON)----- 3, 301

LAWLEY, Patsy NELSON----- 3,300
 Stephanie----- 3,301
 Theresa (CALLEN)----- 3,201
 LAWRENCE, Mary K WARREN-- 3,345
 LAWSON, Gladys (CALLEN)-- 1,111
 Vernon----- 1,111
 LAWTHER, Mabelle (CALLEN) 1,126
 LEAL, Bessie B (CALLEN)-- 1,182
 Marvin Charles----- 1,182
 LEASURE, Aaron----- 1,19
 Malinda (RAYBURN)----- 1,19
 LEATHERS, A.D.----- 3,5
 Elizabeth CALLEN----- 3,20
 Tennessee Sara (CALLEN) 3.5
 LEE, Phillis CALLEN----- 4,55
 Tommie Helm CALLEN----- 3,42
 LEEPER, Kate CALLAN----- 3,93
 LEHMAN, Diane CALLEN----- 1,246
 LEMASTERS, Beatrice (CALLEN) 1,248
 Charles Ronald----- 1,248
 Robert James----- 1,248
 LEMON, Vivian (SANDERS)-- 3,147
 LEMOYNE, Lavanche (CALLAN) 3,102
 Zanthia CALLAN----- 3,192
 LIGHTSEY, Sandra Kay----- 3,118
 Tabitha (DEAN)----- 3,118
 William----- 3,118
 LILES, Della J (CALLEN)-- 3,115
 LINSAY, Carrie CALLEN---- 4,18
 Jacob----- 4,18
 Jane----- 4,18
 LITTLES, Elizabeth CALLEN 2,41
 LITTLETON, "Sallie" Sarah 3,12
 LIVENGOOD, Adalaide (CRYTZER) 1,168
 Bryan----- 1,230
 Candice----- 1,230
 Ellen Sue ALLEN----- 1,232
 John----- 1,230
 John----- 1,230
 Justin----- 1,230
 Kelly----- 1,230
 Mary Beth FOSTER----- 1,231
 Raymond----- 1,168
 LOGAN, Ida Bell (CALLEN)- 1,64
 Fannie CALLEN----- 3,35
 Wayne----- 1,64
 LONG, Florence Purcell--- 3,183
 "Florrie" (PURCELL)----- 3,183
 Wallace P----- 3,183
 LOWE, Julia Mae CALLEN--- 1,133
 LOWERY, Lena CALLEN----- 3,200
 LUDKE, Catherine CALLEN-- 2,32
 LUKMIRE, Gregory S----- 3,215
 Nan (KIRKPATRICK)----- 3,215
 LUSHER, Francis TACKETT-- 1,123
 LYMAN, Angel Dawn----- 3,384

LYMAN, Cheryl A (CALLEN)- 3,384
 Geneva (MONTGOMERY)---- 3,384
 John David----- 3,384
 John David Jr----- 3,384
 Meagan Sheree----- 3,384
 LYNN, Gladys G SIMMONS--- 1,237

 MCBRYAR, Ada M St CLAIR-- 2,21
 Elizabeth (DICKEY)----- 2,7
 Hattie Dickey----- 2,7
 James----- 2,7
 James C----- 2,7
 Lizzie J----- 2,7
 Sarah Jane (CALLEN)---- 2,7
 William, Dr----- 2,7
 William Lyle----- 2,7
 McCABE, Eva J DERBY-CALLEN 4,43
 McCALL, Jas----- 1,13
 Sarah (REICHART)----- 1,13
 McCLURE, Cathy Sue NELSON 3,396
 McCONAHAY, Brian Dwain--- 4,65
 Dorothy F (CLARK)----- 4,65
 Hollis LeRoy----- 4,65
 Nancy E FRANTZ----- 4,65
 McCRARRY, Eugene----- 4,80
 Evelyn (CALLEN)----- 4,80
 Gerry----- 4,83
 Jennifer (GREEN)----- 4,83
 Jessica----- 4,83
 Joel----- 4,83
 Paul----- 4,80
 Roger----- 4,80
 McCRAY, Dorcas O (CALLAN) 3,101
 John N----- 3,195
 Judith A WILEY----- 3,289
 Linda J RUDD----- 3,290
 Megell WARREN----- 3,194
 Odel V (HASTON)----- 3,195
 Thomas----- 3,101
 McCURDY, Mary KIRKPATRICK 3,9
 McCUTCHEON, Eva (CALLEN)- 1,63
 McDERMOTT, Catherine E--- 3,372
 James Oswald----- 3,372
 Jimmie Onita (ADAIR)--- 3,372
 Linda Susan----- 3,372
 Pamela Jo----- 3,372
 Patricia Ann----- 3,372
 William J Jr----- 3,372
 William Joseph III----- 3,372
 McELWAIN, Ada CALLEN----- 3,48
 Margaret (CALLEN)----- 3,34
 Mary (CULBERHOUSE)----- 3,34
 Nancy S (CALLEN)----- 3,36
 Robert N----- 3,36
 Samuel Pinkney----- 3,34

McFADDEN, Dr James-----	1,42	MADIGAN, Mary CALLEN-----	1,165
Margaret RAYBURN-----	1,42	MAERKER, Bruce Wayne-----	2,54
McGAHEE, John O-----	3,15	Ixchel S (DIMETRAL)-----	2,54
Mary (CALLEN)-----	3,15	MAGNUS, Marlys CALLEN-----	2,50
McGANN, Anna CALLEN-----	1,117	MAJERSKY, Lana Y (NALE)--	1,267
McGILVRAY, Elma DOVE-----	3,125	MALLORY, Nancy CALLEN-----	4,82
McGINNIS, John Thomas-----	1,125	MARLAR, Filicia Ann-----	1,233
Mable (CALLEN)-----	1,125	Melinda Lea-----	1,233
Wayne-----	1,125	Robert Keith-----	1,233
McGLOTHLIN, Carol WILLIAMSON	3,319	Wilma May (CALLEN)-----	1,233
McGOWAN, Deborah (CALLEN)	4,73	MARLOVITS, Gwenleen (CALLEN)	1,180
Heather Lee-----	4,73	Joseph-----	1,180
Rodney-----	4,73	Judith Elaine CORRIE---	1,234
McLEOD, Ann C WARREN-----	3,209	MARSHA, Mary B MORROW----	3,294
McKAY, Ida CALLEN-----	3,106	MARSHALL, Annie E CALLEN-	3,38
McKELVEY, Mack-----	1,90	Hugh, Dr-----	3,38
Mary Luella (BIRD)-----	1,90	MARTIN, Ann (CALLEN)-----	3,16
MCKINLEY, Dorothy (CALLEN)	1,214	Alexander Knight-----	3,353
Earl-----	1,214	David-----	3,353
Jean MOON-----	1,214	Henry-----	3,16
William-----	1,214	Francis Olivia AVERYT--	3,52
MCKINNEY, Evelyn (CALLEN)	1,102	Keith-----	3,393
J.B., Dr-----	1,102	Kay Angela (KNIGHT)----	3,353
Jessie Evelyn-----	1,102	Lisa (MILLER)-----	3,393
Paul George-----	1,102	Melissa CALLEN-----	3,19
MCKNIGHT, Eliza (CALLEN)-	2,13	Myrtle WILLIAMSON-----	3,325
Emeline (CALLEN)-----	2,8	R.L.-----	3,393
James A-----	2,8-2,13	Taylor-----	3,393
Mary Callen-----	2,13	Wanda (PARKER)-----	3,393
MCKOWN, Caroline (CALLEN)	2,9	Wilford-----	3,393
Jacob H-----	2,9	MASCIA, Gertrude-----	3,246
John H-----	2,9	Michael L-----	3,246
Rebecca J (CALLEN)-----	2,10	Pamela-----	3,246
Robert-----	2,10	Trudy Belle-----	3,246
Robert C-----	2,10	MASON, Nancy WILLIAMSON--	3,131
William-----	2,9	MASTERSON, Annie-----	2,16
McLAUGHLIN, Alice BELDING	1,108	Margaret (CALLEN)-----	2,16
McLEOD, Ann C WARREN-----	3,344	Nettie E-----	2,16
Orin GLASS-----	3,158	Robert D-----	2,16
McMASTERS, John-----	1,266	Samuel-----	2,16
Martha-----	1,266	MATHER, Gary-----	1,170
Vickie CALLEN-----	1,266	James-----	1,170
McMURRAY, Martha KIRKPATRICK	3,6-3,9	Julia Nancy (CALLEN)---	1,170
McMURRY, Harriet (CALLEN)	4,8	MATTERN, Linda M CALLEN--	1,226
McNEIL, Edna (CALLEN)----	1,53	MATTHEWS, Elizabeth CALLEN	3,20
McNELLIS, David Thomas---	1,288	MAUPINE (also see MOUPINE)	
Edna Marie (CALLEN)----	1,247	Elizabeth (CALLEN)-----	4,1
Frank-----	1,247	Morgan G-----	4,1
Mary (CALLAHAN)-----	1,247	MAY, Jeanne WILLIAMSON---	3,319
Stephen A-----	1,287	Mary STEELE-----	1,43
Thomas F-----	1,247	MAYO, Eula (WILLIAMSON)-	3,231
McCRANEY, Gladys (KIRKPATRICK)	3,234	Napoleon B-----	3,231
John Kelley-----	3,234	MEAD, Barbara PURCELL----	3,367
McWHIRTER, Annie COLLINS-	3,271	MEADOWS, Teresa J CALLEN-	1,243
MACKEY, Doris I CALLEN---	1,169	MEASE, Josephine N CALLEN	1,115
Dorothy H CALLEN-----	1,196	MEEKINS, Beverly CALLEN--	1,245

MEES, Yolanda D WARREN---	3,347	MISNER, Tammy J (CALLEN)-	4,78
MEGAN, Gregory Edward----	3,334	MITCHELL, John W (KING)--	3,128
Henry Lawrence-----	3,334	Joseph Augusta-----	3,128
Katherine Lynn-----	3,334	MOHNEY, Adeline CALLEN---	1,35
Kristin Kerry-----	3,334	Maude BIRD-----	1,89
Linda Ann (GLASS)-----	3,334	MONK, Edward Marion-----	3,238
MEREDITH, Bernard-----	3,313	Lillie BROWN-----	3,223
Elizabeth A (EVERSULL)-	3,313	Pattie (KIRKPATRICK)---	3,238
Gregory-----	3,313	MONTGOMERY, Geneva LYMAN-	3,384
Moira-----	3,313	MOON, Charles-----	1,214
Ralph-----	3,313	Jean (McKINLEY)-----	1,214
METTLER, Allen-----	1,216	MOONEY, Edward-----	1,31
Marjorie (CALLEN)-----	1,216	John-----	1,31
Melinda-----	1,216	Rose E CALLEN-----	1,31
Stephen-----	1,216	MOORE, Elbert-----	4,49
MIKOTA, John Douglas-----	1,275	Pearl J QUALLS-----	3,388
Shirley Ann (CALLEN)---	1,275	Vera Minnesota (CALLEN)	4,49
Thomas Bryan-----	1,275	MORGAN, Mary E GLASS-----	3,168
MILLER, Ann CALLEN-----	2,1	MORRIS, Charlotte JOHNSON	3,330
Annie CALLEN-----	2,49	David Michael-----	3,368
Dustin-----	2,65	Donald Blanton-----	3,277
Fern AMMONS-----	4,63	Ethel Ida (PURCELL)---	3,277
Hazel Gladys (CALLEN)--	4,30	Joan Alice (PURCELL)---	3,368
Inabee (CALLEN)-----	4,30	John Clinton-----	3,368
Lisa (MARTIN)-----	3,393	Martha J (CHOATE)-----	3,15
Margaret (CALLAN)-----	3,102	Michael Gregg-----	3,330
Margaret (CARNAHAN)---	2,1	Robert-----	1,12
Matthew-----	2,1	Sheila Kay-----	3,330
Melaine P CALLEN-----	2,65	Sophia (WEIR)-----	1,12
Taundra-----	2,65	Tessie PICKENS-----	3,149
MILLICAN, Edith H CALLEN-	3,107	William C -----	3,368
MILLIKAN, Beth M (CALLEN)	1,186	MORRISON, Anna (CALLEN)--	3,30
Donald Dean-----	1,186	Walker-----	3,30
Michael Nevin-----	1,186	MORROW, Clinton Robert---	3,294
MILLIN, Ester GALBRAITH?-	1,20	Gary Dale-----	3,294
MILLS, Dezzie Iona-----	3,86	Judy (CALLEN)-----	3,294
Dorcas Malinda (HOOKS)-	3,86	Lea Ann-----	3,294
Effie Ruth-----	3,86	Mary Belle MARSHA-----	3,294
Farris Leo-----	3,86	Robert T-----	3,294
Georgia Mae GRIZZLE----	3,178	William R-----	3,294
Hugh Clarence-----	3,86	MORRSEY, Elizabeth KIRBY-	2,25
Jewel Estelle-----	3,86	MOSES, Mary A (GILLIGAN)-	1,191
Julia Pauline-----	3,86	MOSHIER, Marilyn L CALLEN	1,166
Martha-----	3,86	MOUPINE, Elizabeth CALLEN	4,10
Mary Elizabeth-----	3,86	Penolopy CALLEN-----	4,9
Robert Maurice-----	3,86	MULLINS, Mabel C CALLEN--	3,211
Wayland-----	3,86	Margaret PERRY-----	3,189
William Robert-----	3,86	MULVANEY, John-----	4,4
Willie Ross-----	3,86	Mary "Polly" (CALLEN)--	4,4
MINESKY, Mary R (CALLEN)-	1,130	MUNDAY, Alice (GENTRY)---	3,316
Ronald-----	1,130	Harvey Lee-----	3,316
MINTEER, Mary (NICHOLSON)	1,19	Tressie WILLIAMSON-----	3,316
Mary RAYBURN-----	1,19	MURPHREE, Allie JONES-JACKSON	3,267
William-----	1,19	Ethel C WALTERS-----	3,265
MISNER, Mike-----	4,78	Ruth Purcell DORSEY----	3,266
Mitchell Callen-----	4,78	Thomas Eugene-----	3,179

MURPHREE, Willie (PURCELL) 3,179
 MURRAY, Carol M (GLASS)--- 3,332
 Drew David----- 3,332
 John----- 1,21
 Keeland Charles----- 3,332
 Louise Ester CALLEN---- 1,142
 Mark----- 3,332
 Megan Lane----- 3,332
 MURRELL, Aaron Lee----- 1,276
 Jeannette M CALLEN---- 1,276
 Logan Paul----- 1,276
 Roger David----- 1,276
 MUTLEY, Paulette (CALLEN) 2,50
 MYERS, Elsie M BENNETT--- 1,198
 Harriet C (CALLEN)----- 2,2

 NALE, David Lynn----- 1,199
 Lana Yvonne MAJERSKY--- 1,267
 "Tillie" (CALLEN)----- 1,199
 Robert Eugene----- 1,199
 NELSON, Adaline (ASHWORTH) 3,318
 Bob----- 3,300
 Carl August----- 2,31
 Carrie C CALLEN----- 2,31
 Cathy (McCLURE)----- 3,396
 David William----- 3,396
 Doris K (WILLIAMSON)--- 3,318
 Elizabeth A (WILLOUGHBY) 3,395
 Jasper Newton----- 3,318
 Leslie----- 3,300
 Lloyd Prentice----- 3,318
 Mary Elizabeth (ILER)--- 2,31
 Melanie----- 3,300
 Patsy (LAWLEY)----- 3,300
 Randall Lloyd----- 3,395
 Tracy Evelyn----- 3,396
 NEVILLE, Luke----- 3,223
 Melba (BROWN)----- 3,223
 NICELY, Charles Augustus- 3,169
 Mary Jane SALMON----- 3,255
 Mattie L (GLASS)----- 3,169
 NICHOLS, Bettie (CALLEN)- 1,218
 Debra Joan----- 1,218
 Frank M----- 1,218
 Frank Michael----- 1,218
 Hugh C----- 1,33
 Jane Eliza "Jennie"--- 1,60-1,74
 Ross----- 1,33
 Sarah L (CALLEN)----- 1,33
 NICHOLSON, Mary MINTEER-- 1,19
 NICKLAS, Birdie L (GLASS) 3,250
 W.C. "BLACKIE"----- 3,250
 NIGH, Deborah (BRUNNER)--- 3,379
 Edgar Lee "Bill"----- 3,285
 Elizabeth A HAYES----- 3,380

NIGH, Lindsey E----- 3,378
 Mary K (CALLAN)----- 3,285
 Rebecca L (BISHOP)----- 3,378
 Robert Lynn----- 3,379
 William Lee----- 3,378
 NORRIS, Nancy Chambers--- 4,8
 NUNN, Alia Patricia----- 1,290
 Harold----- 1,290
 Kailli Kristine----- 1,290
 Kathleen (BALLENGER)--- 1,290
 NUTTER, Nancy E CALLEN--- 1,45

 O'CALLEN----- pg 325
 O'DENBAUGH, Caroline (CALLEN) 1,62
 Edward D, Jr----- 1,62
 O'HARROW, Fern M CALLEN-- 3,117
 O'QUIN, Ruthann Eversull- 3,127
 OLIVE, Vela GLASS----- 3,162
 OLSEN, Leannah Mae----- 3,387
 Russell----- 3,387
 Sherrie (SULLIVAN)---- 3,387
 OSBORN, Malinda CALLEN--- 2,14
 OSTRING, Helen CALLEN--- 4,62
 OTT, Rose C CALLEN----- 2,19
 OTTO, Judy (CALLEN)----- 1,162
 OVER, Arminta A (CALLEN)- 1,71
 Clara----- 1,148
 Elaine----- 1,147
 Elizabeth (WENTLING)--- 1,150
 Elmer----- 1,150
 Faye----- 1,147
 Gary----- 1,147
 John----- 1,71
 Joyce----- 1,150
 Merl----- 1,147
 Phyllis (WENTLING)---- 1,147
 Ruth----- 1,149
 Shirley----- 1,147
 "Zula" (CALLEN)----- 1,71

 PACK, Valerie (CALLEN)--- 3,208
 PACKARD, Reba M (CALLEN)- 4,51
 PALMER, Barbara CHAMBERS- 3,341
 Henrietta CALLEN----- 1,161
 Nanette Rae----- 3,341
 Robert Charles----- 3,341
 Stephanie Anne----- 3,341
 PARCEL, Judy (CALLEN)--- 4,81
 Shawn----- 4,81
 PARKER, H Clay----- 3,24
 Martha (KIRKPATRICK)--- 3,24
 Ruby Lee (BENNETT)---- 3,315
 Wanda MARTIN----- 3,393
 Wilford----- 3,315

PARTRIDGE, Elizabeth STAHLMAN	1,189	PICKENS, Howell Frank----	3,148
PATRICK, Kelly-----	3,304	Jessie Brooks-----	3,68
Novita (CALLEN)-----	3,304	Minnie Lou SANDERS----	3,147
Pat-----	3,304	Nancy H (CALLEN)-----	3,28
Tiffany-----	3,304	Nell-----	3,153
PATTERSON, Eva JENKIN----	2,28	Noby Renolds-----	3,150
PAUL, Alice J ABERNATHY--	3,357	Nota (SHEPPARD)-----	3,156
Jane "Jennie" CALLEN---	2,2	Oliver Elmo-----	3,156
Jane (PORTERFIELD)-----	2,2	Pearl Lillian-----	3,151
Samuel-----	2,2	Peggy-----	3,149
PAYNE, Alice COWGILL-----	4,1	Roselle-----	3,153
PEAKE, Nannie KIRKPATRICK	3,215	Samuel Ross-----	3,68
PECK, Ruby T KIRKPATRICK-	3,235	Samuel Ross "Bud"-----	3,153
PELAZINI, Carol (SIMMONS)	1,279	Sheppard Frank-----	3,148
Dwane-----	1,279	Tessie (MORRIS)-----	3,149
PENIX, David-----	3,364	Zeno-----	3,28
Harriett E (KNOX)-----	3,364	PIEPER, Gladys A CALLEN--	2,47
PERDUE, Bolling-----	3,23	PIERCE, Jane KIRKPATRICK-	3,123
Franklin-----	3,23	Karol BAUGHER-----	4,73
James H-----	3,23	"Maude" (KIRKPATRICK)--	3,124
John H-----	3,23	Prentiss L-----	3,124
Margaret-----	3,23	PIGEON, Rosa CALLAN-----	3,99
Martha DEAN-----	3,60	PIKE, Mary Jane GEORGE---	3,89
Nancy (KIRKPATRICK)----	3,23	PILQUIST, Amanda A (CALLAN)	3,94
Samuel K-----	3,23	Goodrich E-----	3,94
PERRY, Burrel Bird-----	3,189	Murel CROOM-----	3,94
Burrell Byrd-----	3,189	PINARD, Phyllis CALLEN---	3,307
Edith L (AVERYT)-----	3,189	PINGLEY, Eva ROSENCRANCE-	1,92
Elsie Lucille TUCKER---	3,283	PLASS, Hildegard SHAW----	1,213
Margaret Bird (MULLINS)	3,189	PLATTENBURG, George Preston	4,54
PETERS, Blanche E (CALLEN)	3,117	Mary Virginia-----	4,54
Mary Ella CALLEN-----	1,66	Velma (CALLEN)-----	4,54
PETERSON, Elva CALLEN----	1,141	POKORNE, Mary E (CALLEN)-	2,31
Katherine E (CALLEN)---	1,277	Stanley R-----	2,31
Steven Patrick-----	1,277	POLLOCK, C.H.-----	1,13
PETREE, Mabel (CALLEN)---	1,51	Caroline (REICHART)----	1,13
PETTIS, Jessie (KIRKPATRICK)	3,145	POOLE, Ariel Caitlin----	2,55
William Wallace-----	3,145	Collin Mackenzie-----	2,55
PHIELPS, Amytus CALLEN---	1,51	Diana L (DIMETRAL)-----	2,55
PHILLIPS, Edrie (CALLEN)-	4,51	Roy Allen-----	2,55
Fred (Frank?)-----	3,25	PORTERFIELD, Jane PAUL---	2,2
James-----	3,25	POSZYWAK, Mae M (CALLEN)-	2,35
Marion-----	3,25	Peter-----	2,35
Martha M (KIRKPATRICK)-	3,25	POWELL, Debra LAWLEY-----	3,391
Ned-----	3,25	POWERS, Anastasia COLLINS	3,272
William-----	3,25	POWLEY, Mamye M (DICKEY)-	2,24
PICKENS, Alabama (ZIEGLER)	3,63	PRATT, Stephen John-----	3,332
Annie (DOWNING)-----	3,153	Carol (GLASS)-----	3,332
Aubrey Preston-----	3,149	PRESLEY, Daina (ADAMS)---	3,245
Bama-----	3,149	Daina Patricia-----	3,245
Bennie Zeno-----	3,155	Gertrude Rebecca MASCIA	3,246
Bertha (HOWELL)-----	3,148	Malcolm Holmes-----	3,245
Bessie R GUICE-FREY----	3,152	Percy Holmes-----	3,161
Christine-----	3,153	Rebecca A (GLASS)-----	3,161
Clyde Elcano-----	3,68	PREWITT, Ruby (BENNETT)--	3,315
Connie Agnes ANDERSON--	3,154	V.L.-----	3,315

PRICE, Anne E (CALLEN)--- 1,272
 Christopher Michael---- 1,272
 Ralph Stanley, Jr----- 1,272
 Robert Allen----- 1,272
 PROOS, Jack----- 3,261
 Sue Carol (FULTZ)----- 3,261
 PRUITT, Beulah (SLAYTON)- 3,188
 PRUNTY, Jessie Ann----- 1,268
 Joshua Matthew----- 1,268
 Kevin----- 1,268
 Tina H (BERLIN)----- 1,268
 PULLIAM, Betty CALLEN---- 1,205
 PURCELL, Amanda Clare---- 3,369
 Barbara (MEAD)----- 3,367
 Betsy Ann (DALE)----- 3,369
 Carol Ann WILSON-STEVENS 3,366
 Caroline R (GRAY)----- 3,276
 Christopher Douglas---- 3,369
 Clare----- 3,184
 Clarkie Sophia (DRAKE)- 3,87
 Douglas Clare----- 3,369
 Ethel Ida MORRIS----- 3,277
 Florence "Florrie" LONG 3,183
 Glenn Austin----- 3,367
 Ida Bernice (WEST)----- 3,184
 Ida Claire SMITH----- 3,278
 Isabell W----- 3,276
 James Davis----- 3,275
 James Michael----- 3,370
 Jeannie D (ROTEBERRY)- 3,370
 Joan A MORRIS-HIXON---- 3,368
 John Callen----- 3,275
 John Robert----- 3,277
 John Robert, Jr----- 3,277
 Joyce (BISHOP)----- 3,275
 Lesley Dianne----- 3,370
 Lois E (WAITS)----- 3,277
 Malcolm----- 3,87
 Martha Isabell (WILLIS) 3,276
 Mary Eliza (CALLEN)---- 3,87
 Matthew Mead----- 3,367
 Myrtle Mae (DAVIS)----- 3,182
 Prestley Waits----- 3,277
 Rachel Ann----- 3,275
 Rebecca Myrtle----- 3,275
 Rosemary (FOWLER)----- 3,367
 Ruby Estelle COLLINS--- 3,181
 Sarah Burnett----- 3,367
 Selma ABERNATHY----- 3,180
 Stacy June----- 3,405
 Susan Victoria----- 3,275
 Thelma Byrnece----- 3,274
 Thomas Malcolm----- 3,182
 Thomas Malcolm, Jr----- 3,275
 Thomas Malcolm III----- 3,275
 William Henry----- 3,87

PURCELL, Wm Wood Rowe---- 3,276
 Wm Wood Rowe Jr----- 3,367
 Willie Callen----- 3,179
 PUTMAN, Vergie CALLEN--- 4,32

QUALLS, Mary E CALLEN---- 3,388
 Pearl J (MOORE)----- 3,388
 T.L.----- 3,388

RADAR, Mary F SAMPLES---- 1,190
 RAGAN, Joni----- 3,296
 Joye Jean (CALLEN)---- 3,296
 Ralph----- 3,296
 Terry----- 3,296
 RAHAM, Clara KIRKPATRICK- 3,43
 RALPH, Dorothy D (GLASS)- 3,251
 Fred Davis----- 3,251
 RALSTON, Mary Ann STEELE- 1,43
 RAUCH, Teresa A (CALLEN)- 1,283
 RAY, Courtney Jane----- 3,350
 Eric Brandon----- 3,350
 Juanita F (CALLEN)---- 1,85
 Rebecca J (GLASS)----- 3,350
 Terry Don----- 3,350
 RAYBURN, Boyd----- 1,18
 Callen----- 1,4
 Calvin----- 1,42
 Calvin Jr----- 1,42
 Cyrus----- 1,18
 Davie----- 1,18
 Eleanor "Nellie" (CALLEN) 1,4
 Ellen----- 1,18
 Ellen (1841)----- 1,19
 Eliza Y STEWART----- 1,19
 Harriet----- 1,19
 Hulda----- 1,18
 Isadora (REYNOLDS)---- 1,94
 James----- 1,94
 James (1769)----- 1,4
 James (1801)----- 1,18
 James H----- 1,19
 Jane----- 1,18
 Jane (GALBRAITH)----- 1,18
 Jefferson----- 1,18
 Jethro----- 1,19
 Malinda LEASURE----- 1,19
 Margaret (BOYD)----- 1,18
 Margaret B----- 1,18
 Margaret J REMALEY---- 1,19
 Margaret M----- 1,42
 Margaret (McFADDEN)---- 1,42
 Mary----- 1,18
 Mary (1844)----- 1,19
 Mary BRANDON----- 1,4

RAYBURN, Mary Ellen-----	1,19	RICH, Arthur Paul-----	3,351
Mary (MINTEER)-----	1,19	Arthur Paul, Jr-----	3,351
Matthew-----	1,19	Cynthia Lynn (GLASS)---	3,351
Matthew Jr-----	1,19	Kimberley Michelle-----	3,351
Nancy E WILSON-----	1,19	RICKER, Matilde (CALLEN)-	1,39
Olive FRANTZ-----	1,19	George C-----	1,39
Rob-----	1,18	RIDGELY, Mildred (ABERNATHY)	3,268
Sarah (GARVER)-----	1,19	Montgomery Rhind-----	3,268
Sarah STEELE-----	1,43	RIDLEN, Dorothy-----	1,262
William-----	1,18	Howard Lee-----	1,262
READ, Ellen (DEADY/DADY)-	3,92	Leo-----	1,262
"Nellie" AVERYT-----	3,92	Linda D (CALLEN)-----	1,262
Robert J-----	3,92	RIFENBERRICH, Louise (CALLEN)	1,72
REAVIS, Lloyd Jr-----	3,175	RIGGS, Lucy CALLEN-----	1,77
Lloyd Sr-----	3,175	ROANE, Mattie L CALLEN---	3,81
Margurete (CALLEN)-----	3,175	ROARK, Germaine CALLEN---	1,153
REDIC, Jane J (JACKSON)--	1,27	ROBBINS, Florence (CALLEN)	1,85
Mary Ann CALLEN-----	1,27	ROBERTS, Janet FLEMING---	1,175
William-----	1,27	ROBINSON, Aubrey-----	3,240
REECE, Andrew J-----	1,14	Aubrey Glass-----	3,240
Kathy Jean (ALLEN)-----	1,156	Courtney-----	3,382
Nancy J (DIXON)-----	1,14	Kay (COURTNEY)-----	3,382
REED, Don-----	3,306	Rena Leigh (GLASS)-----	3,240
Jeff-----	3,306	Robbey-----	3,382
Kelli-----	3,306	ROCK, Charles Stone-----	4,28
Kerri-----	3,306	Mary L (CALLEN)-----	4,28
Kristi-----	3,306	RODGERS, Jeneva (CALLEN)-	2,22
Marvin-----	3,203	ROGERS, Shirley L CALLEN-	2,65
Orelia (CALLEN)-----	3,203	Susan (KIRKPATRICK)----	3,213
Sherry CALLEN-----	1,32	Walter Harrison-----	3,213
Sue (HOWSER)-----	3,306	ROHRBACHER, Cindy SULLIVAN	3,386
REICHARD, Caroline POLLOCK	1,13	Earleen Y (DeJONGE)----	3,386
Eliza LASH-----	1,30	Selden D-----	3,386
Elmira-----	1,13	RONEY, Jane WEIR-----	1,12
Hugh Callen-----	1,13	ROSE, Mary Sophia CALLEN-	1,84
Martha-----	1,13	ROSENCRANCE, Eva B BIRD--	1,92
Mary (CALLEN)-----	1,13	John-----	1,92
Mary STEWARD-----	1,13	Mary Elizabeth (PINGLEY)	1,92
Michael-----	1,13	ROSS, Blanch (CALLEN)----	1,55
Sarah McCALL-----	1,13	Calvin L-----	1,55
REICHEL, Ruth GUICE-----	3,239	Ruby-----	1,55
REMALEY, Margaret (RAYBURN)	1,19	ROTENBERRY, Jeannie PURCELL	3,370
William-----	1,19	ROW, Julia L KIRKPATRICK	3,135
RENNIE, Eleonore FALKENBERRY	3,263	RUBLE, Alice-----	1,122
REYNOLDS, Isadora RAYBURN	1,94	Bulah (CALLEN)-----	1,122
Mabel E BIRD-----	1,167	Francis-----	1,122
Maude (DOOL)-----	1,167	John-----	1,122
Ross-----	1,94	Paul-----	1,122
William H-----	1,167	Violet-----	1,122
RHEA, James Keith-----	3,389	RUDD, Adam M-----	3,290
Mary Lee (JOHNSON)-----	3,389	Buck A-----	3,290
Pamela Bernice CALLEN--	3,389	Kyla R-----	3,290
Pheobe CALLEN-----	1,136	Linda J (McCRAY)-----	3,290
RHINES, Amanda Jane (CALLEN)	1,38	RUMBAUGH, Emma M-----	1,151
Edwin W-----	1,38	Ethel May CALLEN-----	1,151
Orin M-----	1,38	William Lee-----	1,151

RUNYON, Dustin Michael--- 1,286
 Kimberly J (CALLEN)---- 1,286
 Ronald Jr----- 1,286
 Ronald Sr----- 1,286
 RUPP, Elizabeth (COCHRAN) 1,58
 Frances CALLEN----- 1,58
 George----- 1,58
 RUTH, Bud----- 3,112
 Effie (CALLEN) BEAVERS- 3,112
 Edward----- 3,112
 Franklin----- 3,112

ST CLAIR, Ada M (McBRAYER) 2,21
 Blanche----- 2,21
 Fred Callen----- 2,21
 John----- 2,21
 John M (MD)----- 2,21
 Lisle Porter----- 2,21
 Mary Alice----- 2,21
 Paul----- 2,21
 Robert Allen----- 2,21
 William McBryer----- 2,21

ST JOHN, Lora BUCCIGROSSI 1,202
 SALLEE, Barbara J CALLEN- 1,185
 SALMON, David Randolph--- 3,255
 Lucy M CHAMBERS----- 3,337
 Mary Jane (NICELY)----- 3,255
 SAMPLE, Amelia CHOATE---- 3,15
 SAMPLES, Benjamin----- 1,190
 Betty Lou Callen----- 1,190
 Mary Florence (RADAR)-- 1,190
 SANDER, Elsie ABERNATHY-- 3,269
 SANDERS, Ellen (WALTERS)- 3,400
 Gladys THRELKELD----- 3,147
 Howard----- 3,147
 Minnie Lou (PICKENS)--- 3,147
 Raymond----- 3,147
 Steven Layton----- 3,400
 Steven Roy----- 3,400
 Vivian LEMON----- 3,147
 SARGENT, Beatrice (CALLEN) 1,248
 Jason Scott THOMPSON--- 1,248
 Robert Jerome----- 1,248
 SAUL, Janet Louise CALLEN 1,256
 SCHACK, Anna M JENSEN---- 1,110
 SCHEER, Lisa Marie CALLEN 3,311
 SCHENK, Anna R (CALLEN)-- 2,20
 John----- 2,20
 SCHENZ, Margaret E----- 3,363
 Sarah Katherine----- 3,363
 Sarah M (COLLINS)----- 3,363
 Terry----- 3,363
 SCHIFFGENS, Janet Pearl-- 1,138
 Lois May----- 1,138
 Martha Ann----- 1,138

SCHIFFGENS, Pearl (CALLEN) 1,138
 William Henry----- 1,138
 SCHMITZ, Joan C CALLEN--- 1,239
 SCHUCHMAN, Florence CALLEN 1,85
 SCHULMAR, Nancy CALLAN--- 3,193
 SCHULTZ, Mararet W (CALLEN) 3,25
 SCHUMAN, Betty FLEMMING-- 1,134
 SCOTT, Louise (CALLEN)--- 1,41
 Will----- 1,41
 SEABERT, Frank A----- 1,37
 Mary (BIRD)----- 1,37
 SEALE, Jonell GLASS----- 3,259
 SEIFERT, Carl----- 1,68
 Verda L (CALLEN)----- 1,68
 William----- 1,68
 SHADLE, Daniel----- 1,17
 Elizabeth (FOX)----- 1,17
 Jane Callen----- 1,17
 SHAFFER, George B M----- 1,26
 Melida Ann (CALLEN)--- 1,26
 SHANNON, Betty WALDING--- 3,323
 SHARP, Rebecca BIRD----- 1,37
 SHAW, Anne (COPELAND)--- 1,211
 Bertha (CALLEN)----- 1,135
 Bill Alvin----- 1,213
 Charles----- 1,135
 David----- 1,213
 Debra Sue----- 1,208
 Donald Hugh----- 1,208
 Elizabeth (CALLEN)----- 3,12
 Erla Jane WILHELM----- 1,212
 Frank Callen----- 1,209
 Heidi----- 3,305
 Hildegarde (PLASS)----- 1,213
 James----- 3,12
 James----- 1,208
 James Arthur----- 1,135
 James Jackson----- 1,135
 Jim----- 3,305
 Joseph Hugh----- 1,211
 Juniata (AIRHART)----- 1,210
 Mary Elizabeth JONES--- 1,207
 Nelle Latimer BELDING-- 1,107
 Onica (CALLEN)----- 3,305
 Richard II----- 1,210
 Richard Carl----- 1,210
 Robert L----- 1,208
 Tammy----- 3,305
 Thelma (DUBLIN)----- 1,208
 SHELTON, Dana Christopher 3,374
 Destiny (WILDMAN)----- 3,374
 Linda K (CALLAN)----- 3,374
 Elizabeth Rebecca----- 3,374
 Richard----- 3,374
 SHEPARD, Mary Opal CALLEN 4,40
 Nancy Eveline CALLEN--- 4,38

SHEPPARD, Mary E R GLASS-	3,70	SLAYTON, Susan (TRUITT)--	3,188
Nota PICKENS-----	3,156	Ralph Dennis-----	3,373
SHIPP, Darlene-----	3,298	Virginia G THOMAS-----	3,91
David-----	3,298	SMITH, Alexander Martin II	3,278
Margie (CALLEN)-----	3,298	Bessie WILLIAMSON-----	3,232
Roy-----	3,298	Carolyn (KIRKPATRICK)--	3,215
SHOEMAKER, Rachel (TOWNSEND)	2,6	Chester Lee-----	3,280
William-----	1,5	Chestina CALLEN-----	3,202
SHULTZ, John F-----	3,73	Cindy (TOWNSEND)-----	1,197
Margaret W (CALLEN)-----	3,73	Clare Purcell BAUM-----	3,278
SILVES, Blanche (BASHLINE)	1,132	Clarissa L CALLEN-----	1,31
Frank Hunter-----	1,203	Diana M CALLEN-----	3,46
Herman Day-----	1,132	Ida C (PURCELL)-----	3,278
Martha Jean (KEYS)-----	1,203	Jane Cosby (YANCEY)-----	3,46
Mary CALLEN-----	1,67	Jerry L-----	3,280
SIMMONS, Candace (ARTHUR)	1,278	Kristine BALLENGER-----	1,289
Carol Leanne PELAZINI--	1,279	Laura Bell CALLEN-----	1,59
Cecelia (CALLEN)-----	1,187	Leta H WILLIAMSON-----	3,229
Christine (BALOG)-----	1,278	Lititia Agnes (CALLEN)-	1,24
Dale Jean COVINGTON----	1,280	Lottie O CALLEN-----	1,61
Dorothy J (BIVENS)-----	1,238	Lucius-----	1,31
Dwane Perle-----	1,237	Martha Marshall-----	3,278
Dwight William-----	1,238	Matthew-----	3,12
Ervin Lee-----	1,187	Muriel M (GEORGE)-----	3,280
Gladys G (LYNN)-----	1,237	Nancy Lucinda (CALLEN)-	3,12
John Erwin-----	1,238	Ray Harvison BERRY-----	3,371
Keith Lynn-----	1,278	Rebecca GALBRAITH-----	1,6
Susan (FRIZBEE)-----	1,238	Skelton-----	3,46
SIMMS, Debbie (McCAFERY)-	1,236	William Edward-----	1,24
Jordi-----	1,236	William Reese-----	3,215
Sarry-----	1,236	SNEED, Carl-----	3,105
SIMPSON, Elizabeth KENNEDY	3,8	Dora Etta (CALLEN)-----	3,105
SIMS, Sarah Ann BROWN----	3,129	Eula-----	3,105
SIZEMORE, Fonda (CALLEN)-	3,206	Everett-----	3,105
SKEELES, Ella (KIRKPATRICK)	3,214	Neva-----	3,105
Jack C-----	3,214	Richard "Dick"-----	3,105
James William-----	3,214	Ruby-----	3,105
John Kirkpatrick-----	3,214	Vera-----	3,105
SLACK, Andrew M-----	1,34	SNOW, Esther CALLAN-----	3,193
Mary (CALLEN)-----	1,34	SOUZA, Barbara KIESEWETTER	1,223
SLAYTON, Annie L WILSON--	3,188	Joseph James-----	1,223
Augusta Caroline-----	3,91	Winifred BALLENGER-----	1,273
Beulah Mae PRUITT-----	3,188	Winifred C (ALBRIGHT)--	1,223
Bill W-----	3,373	SPANN, Clifford (COOK)---	3,249
Charles Edward-----	3,91	Julius H-----	3,249
Charles Edward II-----	3,91	Leighton-----	3,249
Charlie Wingate-----	3,282	SPEARS, Clara (CALLEN)---	4,44
Cleotus "Skinny"-----	3,188	Ross-----	4,44
Henry Clifton-----	3,188	Harry-----	4,44
Henry Walter-----	3,188	SPILLER, Eileen GLASS----	3,158
Londa Renee BRIDGES----	3,373	SPRIGGS, Deborah CHAMBERS	3,339
Mary Ethel BIBBS-----	3,188	SPRINGER, Annie B CALLEN-	2,17
Mary F (WILLIAMS)-----	3,91	SPURGEON, Laura (CALLEN)-	4,15
Mary Ruth (FORTENBERRY)	3,282	SPURRIER, Cleo Z-----	1,106
Norma JEAN (GARD)-----	3,373	Eleanor-----	1,106
Paul L-----	3,282	Nelle (BELDING)-----	1,106

SPURRIER, Richard Belding	1,106	STEWART, Valerie PACK----	3,208
SQUIRES, Stella M CALLEN-	1,111	Wilma Dean (CALLEN)----	3,208
STAHLMAN, Blanch (CALLEN)	1,55	Winnie WILLIAMSON-----	3,226
Edward John-----	1,189	STILES, Mary (CALLEN)----	1,51
Edward Ray-----	1,120	STOKESBERRY, Nila CALLEN-	4,61
Elizabeth M (PARTRIDGE)	1,189	STOLLER, Elnora D CALLEN-	1,224
George Armstrong-----	1,55	STOLTZ, Helen CALLEN-----	1,140
Lee M-----	1,55	STOPP, Gladys CALLEN-----	1,140
Lucille M DUNHAM-----	1,120	STOVALL, Frances CALLAN--	3,99
Margaret E (DAVIDSON)--	1,120	STRATTON, Mary CALLEN----	1,31
Margaret Ellen-----	1,189	STRAUSS, Margaret (GLASS)	3,174
Martha Jean-----	1,189	Peter Herman-----	3,174
Mary-----	1,55	STRICKLAND, Izella HOLTON	3,64
Paul Vance-----	1,189	Leah WARREN-----	3,348
Richard Lee-----	1,189	STRINGHAM, Joy R (CALLEN)	3,117
STARK, Loraine (CALLEN)--	3,40	STUART (see STEWART)	
Robert W Armstrong-----	3,40	STUTZMAN, Evelyn J BIRD--	1,167
STEELE, Claude-----	1,43	SULLIVAN, Allan Dan-----	3,386
Clifford-----	1,43	Amy Nicole-----	3,386
Clyde-----	1,43	Burnice (BREWER)-----	3,292
Eugene A-----	1,43	Carrie Rachelle-----	3,292
Euene Paul-----	1,43	Cindy (ROHRBACHER)-----	3,386
Harry-----	1,43	Cinthia-----	3,292
Ida CRYTZER-----	1,86	Cristina-----	3,292
Isaac L-----	1,43	Dan Lucas-----	3,292
Jesse-----	1,43	Glenda Callen-----	3,292
John-----	1,43	Kara Marie-----	3,386
Lenore CRAWFORD-----	1,43	Loyd-----	3,292
Mary (MAY)-----	1,43	Sherrie OLSON-HARKRADER	3,387
Mary Ann (RALSTON)-----	1,43	Stacey Ann-----	3,292
Nancy (VAN ORSDALE)----	1,43	SUMMERS, Carl Sedrick----	4,33
Sarah (RAYBURN)-----	1,43	Ethel Gertrude (CALLEN)	4,33
Orlo W (GREARY)-----	1,43	Ethel Lee-----	4,33
STEVENS, Carol (PURCELL)-	3,366	J.H.-----	4,33
Dorothy-----	3,366	Kenneth-----	4,33
Edward Evan-----	3,366	Marion-----	4,33
Gwen Rankin-----	3,404	Opal BALDWIN-----	4,33
Randall Evan-----	3,366	Ora CALLEN-----	1,100
Terrence Clare-----	3,403	William "Bill"-----	4,33
Timothy Evan-----	3,366	SWANSON, Denver Wallace--	3,274
Wendy Kaye-----	3,366	Thelma B (PURCELL)----	3,274
STEWART, John-----	1,13	SWEENEY, Florence (CRYTZER)	1,95
Mary (REICHART)-----	1,13	William-----	1,95
STEWART, Carol Ann (CALLEN)	1,255	SWEET, Earl Reed-----	1,98
Eliza Y (RAYBURN)-----	1,19	Edna Daisy (CALLEN)----	1,98
James-----	1,255	Joseph Travis-----	1,98
James Douglas-----	1,255	SWENSON, Jacob Dan-----	3,312
Jonathan Duane-----	1,255	James Alen-----	3,312
Olivia H-----	3,3	Mark Jared-----	3,312
Randall Devane-----	3,208	Mark Samuel-----	3,312
Randy-----	3,208	Melonie Ann (CALLEN)---	3,312
Rickey-----	3,208	SWINEHART, Deloris CALLEN	1,285
Sarah Ann (CALLEN)----	3,12		
Thomas-----	1,19		
Thomas-----	3,3	TACKETT, Frances (LUSHER)	1,123
Thomas-----	3,12	George-----	1,123

TACKETT, Stashie CALLEN--	1,123	THOMPSON, Warren (Rev)---	1,58
TANNER, H.B.-----	3,24	THORNE, Carey V-----	1,23
Narcissus (KIRKPATRICK)	3,24	Ethna "Belle" (CALLEN)-	1,23
TARDY, Don Carl-----	3,405	THRELKELD, Gladys (SANDERS)	3,147
Stacy J (PURCELL)-----	3,405	Otis-----	3,147
TATMAN, Alma Rae-----	3,167	THUMM, Jacob John-----	1,36
Annie G (GLASS)-----	3,167	Nora May (CALLEN)-----	1,36
Billie Charles-----	3,167	TIBBENS, Grace (CALLEN)--	1,51
Howard Lewis-----	3,167	Jacob Claud-----	1,51
Merton E-----	3,167	TILLERY, Rebecca GLASS---	3,69
TAYLOR, Elizabeth CALLEN-	3,1	TILLMAN, Aslee CALLAN---	3,96
Ena Lee KIRKPATRICK----	3,213	TINSLEY, Annie (WILBORN)-	3,63
Frances GLASS-----	3,159	Catherine (FULLER)-----	3,63
Helen CALLEN-----	2,38	Charity E-----	3,63
Henry-----	3,1	E Viola WILLIAMSON-----	3,130
Jason Scott-----	3,397	Frances (KIRKPATRICK)--	3,63
Katheryn Ivy-----	3,354	George W-----	3,133
Matthew Sean-----	3,397	James F-----	3,63
Mitch-----	3,354	Joseph-----	3,63
Shellee Kathleen-----	3,397	Josiah-----	3,63
Sherry (LAUVE)-----	3,397	Lemuel A-----	3,63
Stacy Elizabeth-----	3,397	Louisiana Bell HICKS---	3,132
Steve-----	3,397	Mary Augusta BROWN-----	3,129
Vickie E (KNIGHT)-----	3,354	Sarah Catherine-----	3,131
TAYSEN, Doris June CALLEN	2,42	TIPTON, Mary Jane DEAN---	3,293
TEACHMAN, Caron CALLEN---	1,178	TODD, Chester Louis-----	1,183
TEETERS, Lillian BIRD---	1,91	Debra Lynn-----	1,183
THARP, Isaac F.-----	1,24	Jennene Kay-----	1,183
Lelia Lois (CALLEN)----	1,24	Kathleen P (CALLEN)----	1,183
THEIN, Beatrice (CALLEN)-	1,248	TOEPFER, Cindy-----	4,86
James Edward-----	1,248	Dennis-----	4,86
THOMAS, Cora Bell (HUGHES)	2,33	Thelma (CALLEN)-----	4,86
Eugenia E (GLASS)-----	3,243	TOLBERT, Douglas Malcolm-	3,121
Hermione (HORNADY)-----	3,65	Essie (WILSON)-----	3,121
Jean Ann CALLEN-----	1,258	Eugenia (KIRKPATRICK)--	3,121
Jett-----	3,65	Grace HODGES-----	3,121
John R-----	3,243	Jennie (BLACKWELL)-----	3,121
John R Jr-----	3,243	John Alton-----	3,121
Lawrence Ogletree-----	2,33	Katie Lee (DAVIS)-----	3,121
Mary Edna CALLEN-----	2,33	Lydia KIRKPATRICK-----	3,119
Rebecca Ellen-----	3,243	Roy-----	3,121
Virginia G (SLAYTON)---	3,91	William Oliver-----	3,121
THOMPSON, Alexander-----	2,1	TORRANCE, Eliza J CALLEN--	2,6
Almira (AGGAS)-----	1,58	Hannah GREER-----	2,19
Beatrice Linda (CALLEN)	1,147	Hugh-----	2,6
Bertha E CALLEN-----	1,58	Mary (GRAY)-----	2,6
Della (CALLEN)-----	1,124	TOWNSEND, Cindy N SMITH--	1,197
Doris Marie CALLEN-----	1,260	Colleen E CALDWELL-----	1,197
Earl-----	1,124	Dorothy (CALLEN)-----	1,197
Hattie (BOOK)-----	1,127	Elizabeth (HINE)-----	2,6
Hulda Mary CALLEN-----	1,127	Leslie Wayne-----	1,197
Jane (CALLEN)-----	2,1	Patricia E WOODDRAW-----	1,197
Jason Scott SARGENT----	1,147	Rachel SHOEMAKER-CALLEN	2,6
Laura (WILLIAMSON)-----	3,224	Robert-----	2,6
Pat LAWLEY-----	3,301	Sandy Kay GREGG-----	1,197
Samuel P-----	1,127	Verylle Bryan-----	1,197

TOWNSEND, Veryle Bryan Jr 1,197
TOWSEND, Edith CALLEN---- 4,47
TREMONT, Beverly (LAUVE)- 3,398
Brian Michael----- 3,398
Chad Christopher----- 3,398
David----- 3,398
Sarah Celeste----- 3,398
TRITT, Linda ABERNATHY--- 3,358
TROSPER, Jannett (CALLEN) 3,204
TRUITT, Susan E SLAYTON-- 3,188
TUCKER, Amy D CALLEN---- 3,115
"Dan" Duard A----- 3,283
Elsie L (PERRY)----- 3,283
TURNER, Fern Callen----- 4,22
Violet (CALLEN)----- 1,159
TUSSY, Luella (DARBISON)- 3,197
Ray----- 3,197

UNDERWOOD, Cassandra----- 4,5
Clarinda----- 4,5

VACLAVAK, Mary E CALLEN-- 4,69
VAN ARSDALE, Charlotte--- 1,158
VAN ORNUM, Jacquelyn CALLEN 3,205
VAN ORSDALE, Nancy STEELE 1,43
VARNER, Sarah GLASS----- 3,29
VESTAL, David----- 3,377
David McKee----- 3,377
Jamie Leigh----- 3,377
Janis L (CALLAN)----- 3,377
VOGEL, Florence B CALLEN- 1,99

WADSWORTH, Vivian CALLAN- 3,120
WAITS, Lois E PURCELL---- 3,277
WAKEFIELD, Annie (CALLEN) 4,6
WALDING, Betty (SHANNON)- 3,323
Charlotte (JACKSON)---- 3,323
James Sherwin----- 3,323
Olan Elmo----- 3,323
WALKER, Lucy CALLEN----- 3,83
WALL, Jane (KIRKPATRICK)- 3,215
John D----- 3,215
WALLACE, Albert L----- 2,26
Elizabeth CALLEN----- 3,17
Etta M (CALLEN)----- 2,26
Rosa Dee CALLEN----- 1,52
Terri CALLEN----- 1,245
WALTER, Ardis H (CALLEN)- 4,51
WALTERS, Alice (BERRY)--- 3,355
Elizabeth M HUDSON----- 3,399
Ellen Claire SANDERS--- 3,400
Ethel (MURPHREE)----- 3,265
WALTERS, Joseph Franklin- 3,265

Joseph Franklin, Jr---- 3,355
Joseph Franklin III---- 3,355
Mary Gene EZELL----- 3,356
WALTON, Bonnie J CALLEN-- 1,177
WANGAMAN, Ruth (CALLEN)-- 1,72
WARD, Cordilia CALLEN---- 2,14
WARREN, Amy Lynn----- 3,344
Andrew Louis----- 3,349
Ann C (MCLEOD)----- 3,344
Bryan Wicker----- 3,345
Carolyn Elizabeth----- 3,345
"Carolyn" (GLASS)----- 3,258
Charles Wicker----- 3,345
Eline Marlene----- 3,347
James Perrin----- 3,347
Jennifer Meadows----- 3,346
John Wells----- 3,346
Joseph Robert----- 3,348
Juna K HARWELL----- 3,288
Laura Ann----- 3,344
Laura L (WILLIAMSON)--- 3,346
Leah (STRICKLAND)----- 3,348
Kate Marie----- 3,348
Margaret Elizabeth----- 3,346
Mary K (LAWRENCE)----- 3,345
Megell (MCCRAY)----- 3,194
R.E.----- 3,194
Rebecca Carolyn (GLASS) 3,258
Stephen Thomas----- 3,345
Sylvia Emille----- 3,347
William Michael----- 3,258
William Michael, Jr---- 3,344
William Powers----- 3,344
Yolanda D (MEES)----- 3,347
WATSON, Basil----- 3,146
Mary E (KIRKPATRICK)--- 3,146
WATTENBARGER, Earl----- 4,34
Effie (CALLEN)----- 4,34
Jean----- 4,34
Lee----- 4,34
Leona----- 4,34
Marie BLANCHARD----- 4,34
Murl----- 4,34
Ray----- 4,34
WEIR, George----- 1,23
Jane (RONEY)----- 1,12
John (Capt)----- 1,12
Mary CALLEN----- 1,12
Sophia MORRIS----- 1,12
WELSH, Ethel M CALLEN-HAYS 4,52
WENDT, Cora CALLEN----- 1,114
WENGER, Ella CALLEN----- 1,63
WENTLING, Elizabeth OVER- 1,150
Phyllis OVER----- 1,147
WEST, Betty ANTILLEY---- 3,328
Ida B PURCELL----- 3,184

WEST, Jane C----- 3,5
 Robert T----- 3,184
 Willie L (WOOD)----- 3,184
 WETZEL, Harry H----- 3,213
 Margaret (KIRKPATRICK)- 3,213
 WHIPKEY, Norma J (CALLEN) 3,209
 Ronald Dean----- 3,209
 Roger Dean----- 3,209
 WHISLER, Wilma O CALLEN-- 4,50
 WHITE, Andrew----- 1,16
 WHITNEY, Deborah (CALLEN) 4,76
 Greg----- 4,76
 Wesley Tyson----- 4,76
 WIDEL, Mary M CALLEN----- 1,172
 WIDNER, Audra G (CALLEN)- 4,41
 Earl Dean----- 4,41
 Edith (CALLEN)----- 4,39
 Janice Sue----- 4,41
 Lee----- 4,39
 Loren----- 4,41
 Peggy Louise----- 4,41
 Shelby Gene----- 4,41
 Wanda Lorene----- 4,41
 Waua Alene----- 4,41
 WIGRIN, James Micketa---- 1,146
 Millicent Fern----- 1,146
 Sarah (CALLEN)----- 1,146
 William----- 1,146
 WILBORN, Annie TINSLEY--- 3,63
 WILDMAN, Destiny SHELTON- 3,374
 WILEY, Jack----- 3,289
 Judith A (McCRAy)----- 3,289
 Kathryn E----- 3,289
 Lori A----- 3,289
 Margaret CALLEN----- 3,46
 Rebecca C----- 3,289
 Tracey A----- 3,289
 WILHELM, Edward----- 1,212
 Erla Jane (SHAW)----- 1,212
 Mary E HOOKS----- 3,44
 Raymond----- 1,212
 WILKERSON, Jill GLASS---- 3,333
 WILLIAMS, Alice WILLIAMSON 3,321
 Arthur----- 3,177
 Augusta----- 3,51
 Clara Ida KNIGHT----- 3,177
 Emma GLASS-FURLONG----- 3,165
 George W----- 3,51
 George Walter----- 3,51
 Jamima (CHOATE)----- 3,51
 Lud----- 3,51
 Mary Francis SLAYTON--- 3,91
 Mary (JONES)----- 3,177
 Stacy Lynn CALLEN----- 3,308
 Virginia M CALLEN----- 1,179
 W.F.----- 3,51

WILLIAMSON, Ada B (DENNIS) 3,226
 Alice (WILLIAMS)----- 3,321
 Alsie (DENNIS)----- 3,317
 Ann (CATO)----- 3,62
 Arlene----- 3,130
 Barbara (HUGHES)----- 3,383
 Bertha----- 3,224
 Bertha Naomi ANTILLEY-- 3,230
 Bessie (SMITH)----- 3,232
 Blanche (DENNIS)----- 3,226
 Brent Lane----- 3,394
 Buna (CHAPMAN)----- 3,232
 C Bell (BENNETT)----- 3,225
 Carol (McGLOTHLIN)----- 3,319
 Carol Sue----- 3,317
 Caroline KIRKPATRICK--- 3,62
 Carolyn Ann CALLEN----- 3,383
 Charlene BRADFORD----- 3,324
 Charles W----- 3,319
 Charley Edgar----- 3,229
 Clyde Edgar----- 3,232
 Daniel R----- 3,130
 Danny----- 3,322
 Doris Kathryn NELSON--- 3,318
 Douglas Leroy----- 3,316
 E Viola (TINSLEY)----- 3,130
 Edgar Harold----- 3,326
 Elijah----- 3,131
 Ellyn Ann----- 3,325
 Eugene Larkin----- 3,227
 Eula Dove----- 3,231
 Eunice P----- 3,131
 Frances Effie JACKSON-- 3,228
 Francis LAUVE----- 3,320
 George Lemuel----- 3,225
 Glenn----- 3,224
 Gordon----- 3,394
 Harold Lee----- 3,383
 Jeanne (MAY)----- 3,319
 Joe----- 3,224
 Karen (DREIBELBIS)----- 3,326
 Kevin Wayne----- 3,394
 Larkin----- 3,321
 Laura Leigh WARREN----- 3,346
 Laura THOMPSON----- 3,224
 Lena (COOK)----- 3,229
 Leon Borden----- 3,232
 Leroy----- 3,321
 Leta Hawthorne (SMITH)- 3,229
 Lillie Francis----- 3,320
 Lori Ann----- 3,326
 Louis Borden----- 3,232
 Luther George----- 3,317
 Martin Allen----- 3,325
 Mary M (DENNIS)----- 3,131
 Mavis C (COOLEY)----- 3,394

WILLIAMSON, Michael----- 3,321
 Myrtle (MARTIN)----- 3,325
 Nancy (MASON)----- 3,131
 Omanda----- 3,322
 Paul----- 3,326
 Phillip Wayne----- 3,325
 Randal Douglas----- 3,316
 Robert Leon----- 3,325
 Ronald Loy----- 3,322
 Rufus Samuel----- 3,226
 Rufus Samuel Jr "Bubba" 3,319
 Ruthie (DAVIS)----- 3,322
 S Charlene BRADFORD---- 3,324
 Sara Catherine (TINSLEY) 3,131
 Sam----- 3,224
 Samuel D----- 3,62
 Susan----- 3,321
 Susan Kay----- 3,325
 Thelma (HICKS)----- 3,227
 Timothy----- 3,326
 Tressie M (MUNDAY)----- 3,316
 Winnie (STEWART)----- 3,226
 WILLIS, Martha PURCELL--- 3,276
 WILLOUGHBY, Donald----- 3,395
 Elizabeth NELSON----- 3,395
 Marian----- 3,395
 WILLS, Ginney L CHAMBERS- 3,339
 WILSON, Alice B----- 1,29
 Annie L (SLAYTON)----- 3,188
 Amanda----- 1,11
 Bruce----- 3,366
 Carol Ann (PURCELL)----- 3,366
 Carrio A----- 1,29
 Cyrus----- 1,19
 E Bertha----- 1,29
 Elizabeth E----- 1,29
 Emma A----- 1,29
 Essie TOLBERT----- 3,121
 Hugh Callen----- 1,29
 Jennie S----- 1,29
 John H----- 1,11
 Margaret----- 1,11
 Mary----- 1,11
 Mary CALLEN----- 1,14
 Nancy E (RAYBURN)----- 1,19
 Samuel----- 1,11
 Sarah----- 1,11
 Sarah (CALLEN)----- 1,11
 WINDHAM, Ethel (HORNADAY) 3,65
 WOLF, Audrey Ellen----- 1,103
 Faye (CALLEN)----- 1,103
 George----- 1,103
 George (1916)----- 1,103
 WOOD, James Green----- 3,67
 Loyd B GLASS----- 3,159
 Nancy Hulda (BARGANIER) 3,67

WOOD, Rosa D CRYTZER----- 1,95
 Samantha KIRKPATRICK--- 3,67
 Willie L WEST----- 3,184
 WOODCOCK, Audrey (CALLEN) 4,22
 Earl----- 4,22
 Edith P (CALLEN)----- 4,22
 Gilbert----- 4,22
 WOODMAN, Campbell Victua- 3,254
 Linda Lou (GLASS)----- 3,254
 WOODS, Adolph----- 1,144
 Darl "Corky"----- 1,144
 Helen (CALLEN)----- 1,144
 John----- 2,1
 Marlene CALHOUN----- 1,144
 Sarah (CALLEN)----- 2,1
 WOODSON, Harriett FULTZ-- 3,261
 Horace Erwin----- 3,173
 Irene E (GLASS)----- 3,173
 WYATT, Mary CALLEN----- 2,15
 WYGAL, Patty A (CALLEN)-- 1,190

YANCEY, Jane C SMITH----- 3,46
 YARNELL, Sharon A CALLEN- 1,252
 YORK, Clifford Wayne----- 3,207
 Katrina Gay BURNEY----- 3,207
 YORK, Larry Wayne----- 3,207
 Steven Dwayne----- 3,207
 Wanda Marie (CALLEN)--- 3,207
 YOUNG, Edna CALLEN----- 1,80
 Shirley Ruth (CALLEN)-- 1,151

ZEIGLER, Alabama PICKENS- 3,68
 Daniel A----- 3,68
 Rebecca (GOLSAN)----- 3,68